

FOUR-STAR 60



BUILDING and FLYING INSTRUCTIONS

SIGRC73



Sig Mfg. Co., Inc....401-7 South Front Street....Montezuma, Iowa 50171

Introduction

In order for your 4-STAR 60 to fly as well as it was designed to, it must be carefully assembled. A model airplane that is not built properly will not fly properly! Remember to work slowly and follow the instructions exactly. SIG, as the kit manufacturer, can provide you with a proven aerodynamic design, quality materials, and detailed instructions, but ultimately the flyability of your finished model depends on how well YOU put it all together.

Wood Parts Identification

Wood parts such as standard stick and sheet stock, leading edges, trailing edges, ailerons, elevator, etc., are all easily identifiable by comparing their shape and dimensions to the plans and the "4-STAR 60 COMPLETE PARTS LIST"; therefore we did not feel that there was any need to label these parts. On the other hand, proper identification of the different wing ribs, wing sheet, fuselage formers, etc., can be confusing because some of them are very similar looking, but in fact they are different. Wherever possible, we have labeled (printed) these parts.

About The Wood In The Kit

We strive to supply good quality materials in all SIG kits. However, wood is a highly variable material (unlike man-made plastic or metal), so every single wood part in a kit will probably not have flawless appearance. Often things that look like an imperfection are actually quite acceptable when you consider the function the part will serve. Mineral stains and tiny knots do not seriously affect balsa wood strength. Also, there is a natural tendency for some balsa sticks and sheets to immediately bow upon being cut off from a perfectly square block due to internal stresses in the wood. In most cases, bows in wood parts (such as leading edges) readily straighten out as they are glued into a structural unit. Likewise LitePly fuselage sides, formers, and doublers that are warped will usually straighten right out when they are glued in place. If you are in doubt about the suitability of any part in your kit for its intended purpose, call or write to us for assistance and/or a replacement part.

COMPLETE KIT PARTS LIST

Laser-Cut Balsa

2	3/32"x3"x18" SHT.# 1 - W-1 (Wing Ribs)	1	3/32"x3"x18" SHT.# 2 - W-2 (Wing Ribs)	1	3/32"x3"x18" SHT.# 3 - W-3 (Wing Ribs)	3	3/32"x3"x18" SHT.# 4 - W-4 (Wing Ribs)
5	3/32"x3"x18" SHT.# 5 - W-5 (Wing Ribs)	1	3/32"x6"x24" SHT.# 6 - Top Deck Sheet F-4T, F-5T	1	3/32"x2"x36" SHT.# 7 - Rear Spar Webs	1	3/32"x4"x36" SHT.# 8 - Main Spar Webs
1	3/32"x3"x24" SHT.# 9 - Diagonal Wing Braces D-1 ,D-2,F-1 ,T-2,T-3	1	3/32"x3"x24" SHT.# 10 - Diagonal Wing Braces D-2	1	3/8"x4"x36" SHT.# 11 - Elevators and Rudder	1	1/4"x4"x36" SHT.# 12 - Stabilizer and Fin

Balsa Sheet

4	3/32"x2"x36" Wing Trailing Edge Sheet	4	1/16"x3"x36" Stabilizer and Fin Sheet	2	3/32"x4"x36" Wing Center Sheet		
---	---------------------------------------	---	---------------------------------------	---	--------------------------------	--	--

Balsa Sticks

8	3/16"x3/16"x36" Forward Spars	6	1/4"x1/2"x36" Main Spars and Doublers	5	1/8"x5/16"x24" Rear Fuselage Stringers	4	1/4"x1/4"x36" Rear Wing Spars
1	3/4" Triangle x18" Firewall, Wing Bolt Blocks, Landing Gear Plate Braces	1	1/2" Triangle x6" Tail Fairing Blocks	1	1/4"x3/8"x36" Stabilizer and Fin	1	1/4"x5/8"x12" Fin Trailing Edge

Special-Cut Balsa

2	5/16"x36" Leading Edges	2	1/4"x1/2"x36" Trailing Edges	1	1/2"x1"x6" Trailing Edge Fill-In	1	1"x1"x6" Wing Dowel Support Blocks
2	3/8"x1-5/16"x2-3/8" Ailerons						

Laser-Cut Lite-Ply Plywood

1	1/8"x4-1/2"x6" SHT.# 13 Fuselage Top, Stab Mount	2	1/8"x6"x42" SHT.# 14 Fuselage Rear, Tip Rib	1	1/8"x4-1/2"x32" SHT.# 15 Fuselage Bottom, APG,HR,TWM, and Dual Tool	1	1/8"x6"x24" SHT.# 16 Fuselage Formers and Tank Floor
1	1/8"x9-1/2"x5" SHT.# 17 Fuselage Bottom Front	2	1/8"x6"x38" SHT.# 18 Fuselage Front and Fuselage Doublers				

Laser-Cut Birch Plywood

1	1/16"x4"x9-1/2" SHT.# 19 Hatch Covers, Wing Hold-Down Plates	1	1/8"x4"x15" SHT.# 20 3ply Dihedral Brace, Servo Tray, F-2D	1	1/4"x4"x8" SHT.# 21 5 ply Firewall, Landing Gear Plate		
---	--	---	--	---	--	--	--

Hardwood

2	3/4"x3/4"x1-1/2" Basswood Wing Hold-Down Blocks	2	1/4"x1-3/4" Wing Dowels	1	1/4"x1/2"x16" Basswood Grooved Hatch Rails	1	3/8"x1/2"x6" Basswood Aileron Servo Mounts
---	---	---	-------------------------	---	--	---	--

Wire Parts

1	1/8" dia. Pre-Bent Elevator Joiner Wire	2	4-40 x8" Aileron Pushrods	4	2-56 x10" Elevator and Rudder Push rods	1	3/32 dia. x7" Tailwheel Wire With Nylon Bracket
---	---	---	---------------------------	---	---	---	---

Hardware

8	#2 x3/8" Sheet Metal Screws (Hatch Covers)	8	#2 x3/4" Sheet Metal Screws (Elev,Rudder,Ailerons)	2	#4 x1/2" Sheet Metal Screws (Tailwheel Bracket)	3	6-32 x1/2" Machine Bolts (Landing Gear)
4	6-32 x1" Machine Bolts (Motor Mounts)	2	6-32 x1-1/2" Machine Bolts (Axles)	4	6-32 Hex Nuts (Axles)	2	6-32 Lock Nuts (Axles)
2	4-40 Hex Nuts (Aileron Pushrods)	2	2-56 Hex Nuts (Elevator, Rudder Push rods)	7	6-32 Blind Nuts (Main Gear and Motor Mounts)	3	#2 Flat Washers (Tailwheel Retainers)
1	Small (Right) Nylon Control Horn (Aileron)	1	Small (Left) Nylon Control Horn (Aileron)	2	Med. (Right) Nylon Control Horn (Rudder and Elev.)	2	1/4-20 x1-1/2" Nylon Wing Bolts

Hardware Continued

2	4-40 Steel RC Links (Aileron)	2	4-40 Solder Clevis (Aileron)	2	2-56 Steel RC Links (Rudder and Elev.)	2	2-56 Solder Clevis (Rudder and Elev.)
2	3-1/2" Glass Filled Motor Mounts	2	Assembly Push rod Connectors (Throttle Pushrod)				

Miscellaneous

1	Clear Molded Canopy	1	.090 Tempered Aluminum Main Gear	2	.200 o.d. x36" Nylon Inner Pushrod Tubing (Rudder,Elev)	2	.270 o.d. x36" Nylon Outer Pushrod Tubing (Rudder,Elev.)
1	.130 o.d. x18" Nylon Tubing (Throttle Pushrod)	1	1/16" Dia. x18" Steel Cable (Throttle Push rod)	1	2"x30" Fiberglass Tape (Wing Center Joint and Tailwheel Wire and Elevator Joiner Wire)	22	Easy Hinges
1	38"x50" Plate #1 Full Size Plan	1	38"x50" Plate #2 Full Size Plan	1	28" Page Photo Illustrated Instruction Book	2	5"x17-1/2" Paper (Aileron Servo Leads)

Decal Sheets

1	8-3/4"x24" DKM-273A Fuselage Stars	1	8-3/4"x24" DKM-273B Right Wing & Stabilizer Stars	1	8-3/4"x24" DKM-273C Left Wing & Stabilizer Stars		
---	------------------------------------	---	---	---	--	--	--

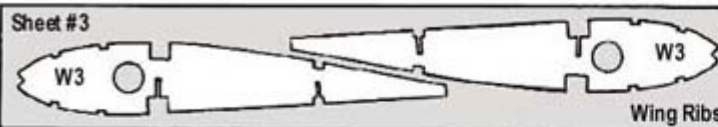
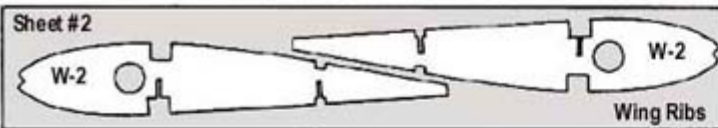
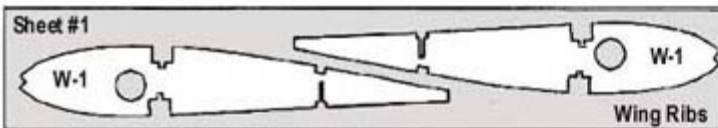

KEY TO Balsa Laser Cut Parts
Use a pencil to mark each of the laser-cut parts according to these diagrams.

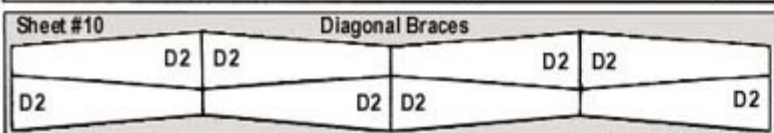
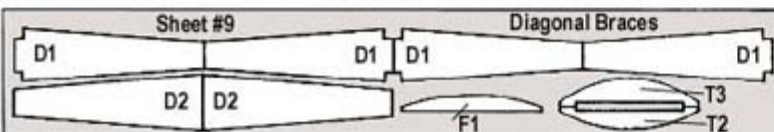
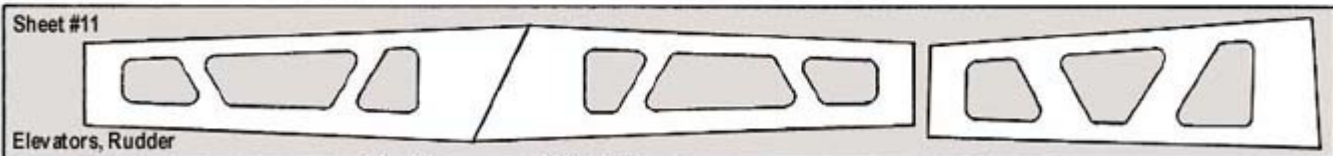
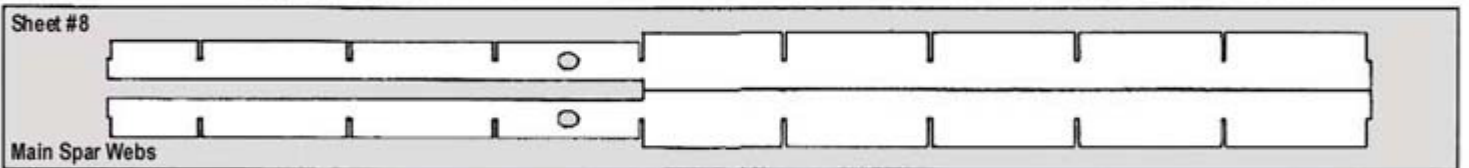
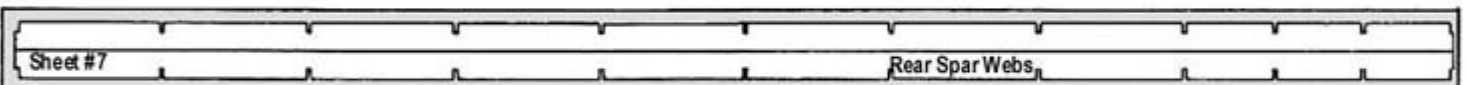
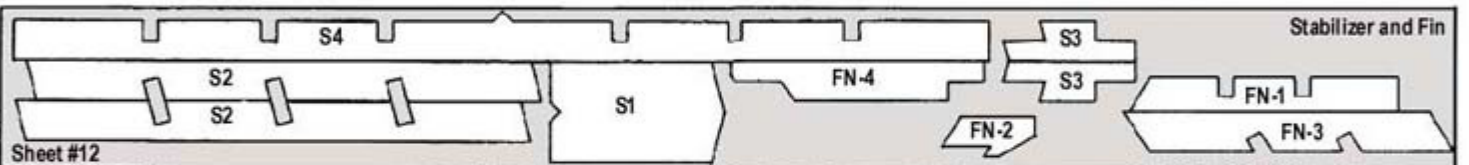
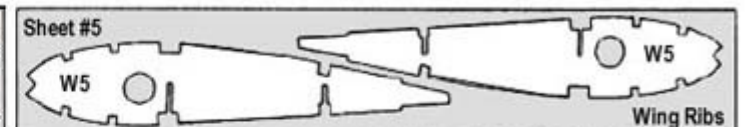
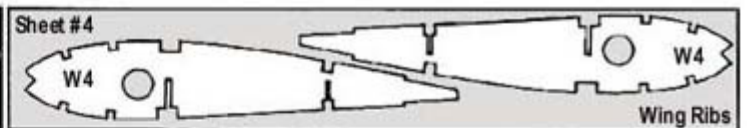

KEY TO LITE-PLY PLYWOOD LASER CUT PARTS

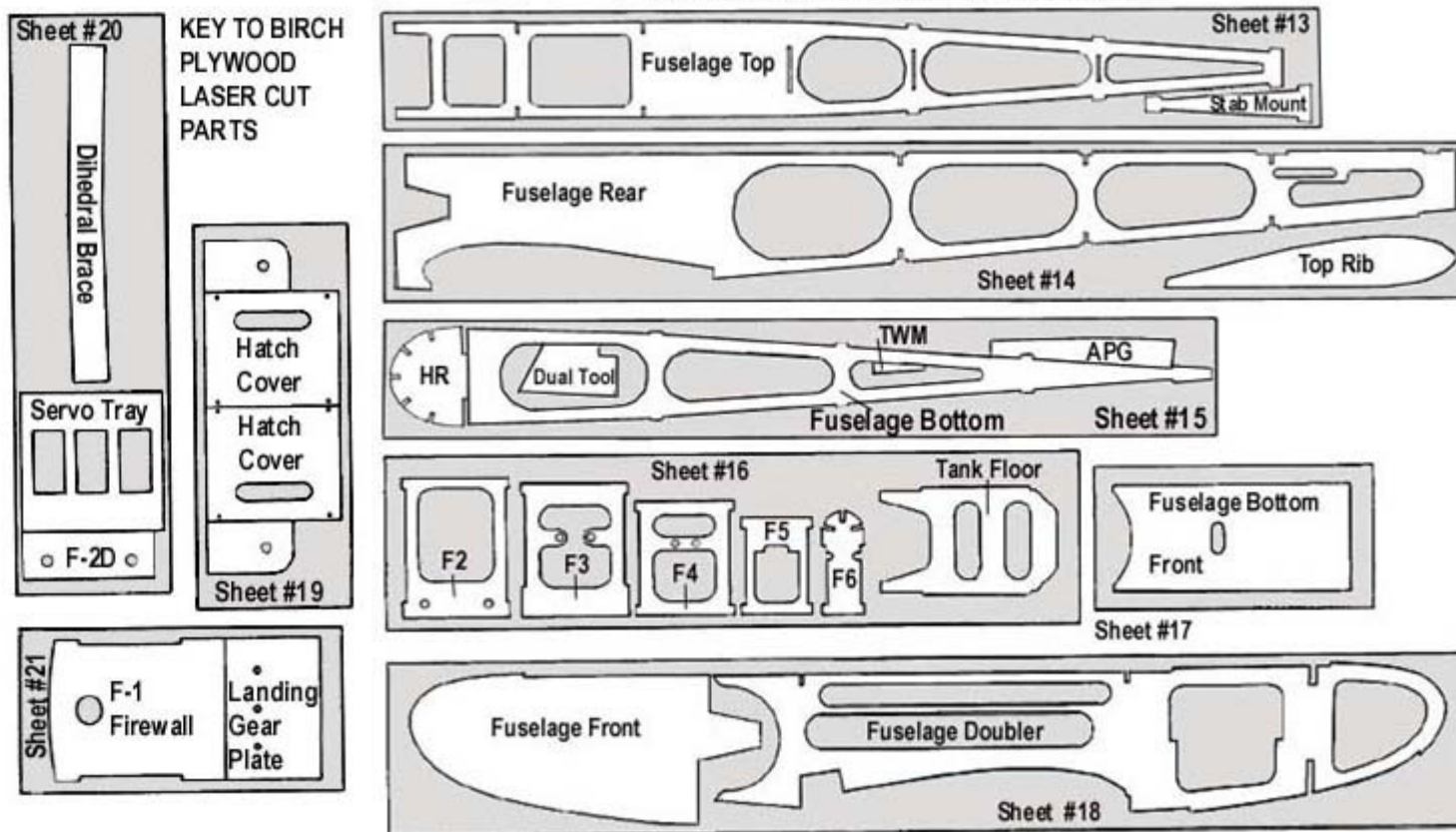

Additional Components Needed

The following items are not supplied in this kit but are needed to complete the 4-STAR 60. Because of the wide variety of brands available and the influence of personal preferences, the choice of these items is left to the builder. All of these items are available from your local hobby shop.

- **.60 to .65 cu. in. 2-Stroke Glow R/C Engine w/Muffler, or .65 to .90 cu. in. 4-Stroke Glow R/C Engine w/Muffler 12 oz. fuel tank, 3-1/4 inch main wheels, and 1-1/4 inch tail wheel.**
Engines larger than those listed are not recommended! Use of oversize engines will cause balance problems and may overload the structure of the airplane. Any normally ported .60 2-stroke glow R/C engine will provide adequate power to fly the 4-STAR 60. We believe that .65 4-stroke glow R/C engine will be the most commonly used engine in the 4-STAR 60, so that is what we've shown on the full-size plans and in this instruction book.
- **Radio Control System**
You will need at least a 4-channel radio control system with 5 servos. One servo to operate each aileron, elevator, rudder, and engine throttle of your 4-STAR 60. The 4-STAR 60's fuselage is spacious enough that any common brand of radio equipment with standard size servos and battery pack can be used. Be certain that your radio system transmits on one of the FCC-approved frequencies for R/C model aircraft.
- **1/2"x 8"x 12" Soft Foam Rubber** (such as SIGRF240)
Use this foam rubber to protect your radio receiver and battery pack from damaging engine vibration. Foam rubber is also used as packing around the fuel tank and radio components to keep them from shifting around in flight.
- **Light-Weight Wood Filler**
For filling holes, nicks, and dents after assembly of the model, but before covering. Regular household "wall repair" or "spackling" compound (3M, Red Devil, DAP, etc.) works well for this. There are also several excellent "model fillers" available at the hobby shop. Just make sure whatever you use is light weight and sands easily. Do not use household patching plaster - it's way too heavy!
- **Glue**
There are so many different types of glue available today for model airplane construction that it can be confusing to even the experienced modeler. To simplify matters, most model airplane glues can be classified as one of four basic types:

1. Cyanoacrylate Adhesives, such as SIG CA, are very strong and bond in just seconds. Dramatically speeds up building time! Different viscosities and cure times are available to suit all areas of model construction.
2. Two-Part Epoxy Glues, such as SIG-KWIK-SET (5-minute cure) and SIG EPOXY (3-hour cure), are super strong but too heavy for general construction. Often used in high stress areas such as the firewall, landing gear, and wing joiners.
3. Water-Based Glues, such as SIG-BOND (aliphatic resin), are very safe and easy to use. Excellent for general construction, although somewhat slow drying.
4. Solvent-Based Model Cement, such as SIG-MENT, is the oldest form of traditional model airplane glue. Still used for general construction by some modelers - especially when building super light weight free flight models.

You could build the 4-STAR 60 using any or all of these four basic types of glue. Each type has different characteristics and advantages, and all of them will result in a bond that is stronger than the materials being glued together. Often times the choice of which type to use boils down to a matter of personal preference based on past experience. However, if you want to get your 4-STAR 60 into the air as quickly as possible, we recommend that you use CA glue for the majority of the assembly of this kit. CA glue is not only fast and strong, but it also makes it possible to do some unique things in the construction sequence. For instance, since CA glue has the ability to penetrate into an already assembled joint, we can first assemble the interlocking fuselage parts "dry" (without glue), then check and adjust the alignment, and finally apply CA to the preassembled joints. This makes it very easy to build a straight and true fuselage in a very short time. If the use of CA glues is new to you, please read "TIPS ON USING SIG CA" below.

- **Building Board** - 12"x38" minimum size

This can be any flat surface that will accept and hold pins - such as insulation board, foam board (cardboard laminated to both sides of a foam sheet), cork bulletin board, soft plywood, a reject "door core" from the lumber yard, etc. The most important thing is that the board must be perfectly flat and untwisted! Your wings and tail surfaces will be built on this board, and if the board is twisted or bowed, the parts you build on it will assume the same shape and your model will not fly properly.

NOTE: The building board you'll see us using in the photos in this book is an 18"x50" piece of 3/4" thick plywood (perfectly flat!), with a same sized piece of 1/4" thick foam board stuck down on top of the plywood with double-sided sticky tape. The plywood provides the rigidity and flatness we need, and the semi-flexible foam board lays flat on the plywood and gives us a surface to push pins into. All materials were obtained from the local lumber yard. Insulation board or cork sheet would make a good substitute for the foam board, if that is not available.

- **80 and 220 Grit Sandpaper**

We prefer either garnet or silicone carbide type open-coat sandpaper. Use the 80 grit to rough sand and shape parts. Use the 220 grit to fine sand the entire model prior to covering. Sand with the grain of the wood whenever possible. Always use fresh, sharp sandpaper. Sharp sandpaper will cut through glue and hard materials easily, giving an even surface. Dull sandpaper will require more pressure and may gouge the surface.

- **Sanding Blocks**

The instructions will call for you to sand some parts of the model using a "sanding block", which is simply a piece of sandpaper backed up by a solid, flat block of wood, plastic, or whatever. A sanding block will give you a much flatter, truer result than you would get with an unbacked, limp piece of sandpaper held in your fingertips. An assortment of different size sanding blocks are indispensable tools for all model construction. There are many styles of commercially made sanding blocks available in hobby shops, or you can make your own.

A good general purpose sanding block can be made by wrapping a full-size standard 9"x11" sheet of sandpaper around a piece of hardwood or plywood, as shown here. This is the most commonly used sanding block in our workshop! Use screws or thumbtacks along one edge to hold the overlapped ends of the sandpaper in place. Put 80 grit sandpaper on the block during general construction, and then switch to 220 grit sandpaper for final sanding just before covering (or make yourself two of these blocks, one for each grit sandpaper).

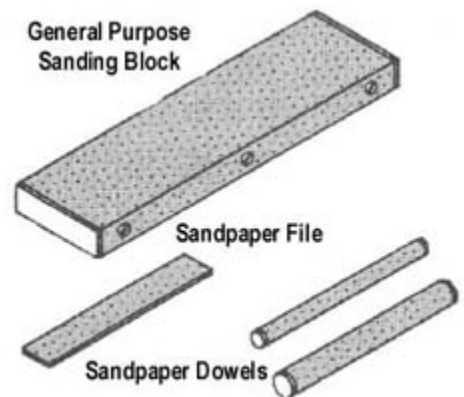

There will be other times when a slightly smaller sanding block is easier to manage. Also, you can make a small sandpaper "file" by simply gluing a strip of 80 grit sandpaper onto a scrap plywood stick. Sandpaper glued or taped to different size hardwood dowels are great for sanding inside curves and holes.

Last but not least, for sanding really large areas, glue 80 grit sandpaper onto a 24" or 36" long piece of aluminum "channel" or "TBar" stock (most hardware stores carry a rack of aluminum extrusions in various sizes and shapes).

How To Use These Instructions

Like a full-size airplane, the 4-STAR 60 is built by first constructing several basic structures - the FUSELAGE, WINGS, STABILIZER, FIN, etc. which are then assembled into a completed airplane. This manual will take you step-by-step through the construction of each basic structure and then the final assembly.

How To Use The Plans

There are two sheets of Plans included in this kit. The plans will be used in several ways. They will help you identify all the parts and determine the relationship of all the parts to each other. They will also be used as a building pattern for the Wing Panels, Stabilizer, and Fin - which will be assembled directly on top of the plans. The plans also show how we would install a typical radio and engine in the 4-STAR 60. By referring to the examples shown on the plan, you should be able to properly install your radio and engine, even if they are not exactly the same as what is shown on the plan.

Everything on the plans is drawn FULL-SCALE, or ACTUAL SIZE to show the correct size, shape, and relationship of all the parts to each other.

Tips On Using SIG CA

SIG CA is a high-purity Cyanoacrylate Adhesive (pronounced "sigh-ano-ack-relate") specially formulated to meet the tough demands of building and flying model airplanes. SIG CA is available in three different viscosities. Each viscosity has different application and cure strength characteristics.

- Thin Viscosity = SIG THIN CA
- Medium Viscosity = SIG MEDIUM CA
- Thick Viscosity = SIG THICK CA

WHICH GLUE FOR WHICH JOINT?

Knowing which viscosity CA glue to use and how much to apply in different types of joints takes some experience. Too much glue causes slow cure, and wastes glue and money. Not enough glue can cause a crash because the joints are weak. Part of the solution is to understand the main material we are trying to glue - balsa wood! The very property that makes balsa so light, the porosity of the big empty cells, makes it draw the glue up into the wood and away from the joint. The first application of CA generally does not leave much glue in the joint, particularly if the balsa is end grain and/or the glue is too thin. A second application of CA glue can finish filling the joint and will leave a small fillet around the joint. A good rule of thumb: If you don't see a slight fillet of glue around a joint, it means the first application of glue has soaked completely into the wood, and you should apply a second coat of CA. Like any other adhesive, we don't want to end up with "gobs" of CA glue on the outside of the joints. Apply just enough glue to wet the joint area and leave a small reinforcing fillet around the joint. That's how you make the strongest joint possible with any glue! Let's discuss how and where each SIG CA product should be used.

1. **SIG THIN CA** is thin as water and cures very fast, normally in 1-3 seconds.
THIN CA is used to glue together parts that fit tightly together with no gaps, and that do not require repositioning after the glue is applied. Typically the two parts are mated first, and then THIN CA is flowed along the joint. Capillary action wicks the THIN CA deep into the joint, resulting in a very strong bond. THIN CA sets very rapidly, so do not expect to move parts at all after the glue is applied. THIN CA is ideal for tack gluing assemblies together quickly on the building board (later the joints should be re-glued with Medium CA). Also good for repairs where you have a lot of cracks or torn wood fibers to be glued together. The THIN CA wicks into every nook and cranny of the break and ties the fibers together almost like new. THIN CA can also be used for applying fiberglass cloth reinforcing. THIN CA is the only glue that should be used on SIG EASY HINGES.
2. **SIG MEDIUM CA** is medium viscosity and normally cures in about 5-15 seconds.
MEDIUM CA is the general purpose favorite, excellent for almost any step during construction. Many people use it for the majority of their construction. Can be used on less than perfect joints, filling in the minor gaps between the parts. MEDIUM CA can be flowed into an already assembled joint (ala THIN CA),
3. **SIG THICK CA** has a thick, syrupy viscosity and the slowest setting time, normally curing in 30-90 seconds. Typically THICK CA is applied to one part before mating to the other part. Longer cure time allows you a few seconds to position the part before the THICK CA "goes off". Cure can be quickened with the use of "accelerator" once the part is positioned. The thick consistency reduces the tendency to run and fills gaps between parts. Ideal for gluing large parts like wing sheets and fuselage doublers. Can also be used to build up strong fillets around joints requiring extra strength.

4. **SIG KWIK-SHOT CA ACCELERATOR** - While CA glues are faster curing than any other type of modeling glue, there are still times when we wish we could make it cure "on command". That's where CA ACCELERATOR comes in! It's a special liquid, that comes in a small spray bottle, that makes any type of CA glue set instantly on contact! CA ACCELERATOR is sprayed onto the joint after the glue is applied and after the part is in final position. The ACCELERATOR chemically reacts with the glue causing it to set immediately. ACCELERATOR is most often used with MEDIUM or THICK CA - it should not be used on THIN CA (which cures almost instantly all by itself). Spray on the ACCELERATOR sparingly! Too much can cause CA glue to react too rapidly and literally boil. This will result in a joint with a chalky white color which is not nearly as strong as a normal joint.
5. **SIG CA DEBONDER** - A special chemical that softens and loosens dried CA glue so you can un-stick things you didn't mean to glue together - like your fingers! Apply DEBONDER to the area and wait for the glue to soften. Don't rush it! It may take 20 to 30 seconds of soaking to get your fingers back apart. For a thick buildup of glue, you may need several applications of DEBONDER to remove it all..

MORE IDEAS ON USING CA GLUE

- **CURING TIME** - The cure times stated for CA glues normally refer to the amount of time it takes for the glue to cure to the point where you can let go of the part and not have to worry about it moving. Even though CA glues reach that point very fast, they are not actually fully cured for some time. The thicker the glue, the longer the total cure time. This is especially true of MEDIUM or THICK CA that has been accelerated. The accelerator makes the glue cure on the surface immediately, but total curing of the glue underneath the surface takes several minutes more. Try not to put any major stress on the glue joint right after it is done. Even a few minutes will see a great increase in the strength of the joint.
- **CLEAN SURFACES** glue better! Any surface contamination reduces the strength of the bond. A quick swipe with sandpaper will prepare most wood joints for a good bond.
- **DON'T MIX TYPES OF GLUE!** Don't "tack" a joint with CA and then go back and re-coat the joint with epoxy or water-based glue - or vice versa. The different bonding mechanisms of these unrelated adhesive families, will interfere with each other and a poor, heavy joint is the result. Use only one type of glue in each joint.
- **FOR ULTRA-QUICK ASSEMBLY** of two large pieces, where positioning is easy, try putting MEDIUM or THICK CA on one of the parts, then spray ACCELERATOR directly onto the other part, and then mate the two parts quickly together. This method can provide an instantaneous bond over a large area.
- **TO APPLY GLASS CLOTH** with CA glue, first spray a VERY LIGHT coat of 3M "77 Spray Adhesive" on the area of the model where the glass cloth is to go. Lay the cloth down and work out all the wrinkles. The spray glue will hold it in place. Apply THIN CA to the glass cloth, let soak in momentarily, and then quickly wipe off the excess with a rag (don't stop moving the rag or it may become glued to the model).
- **STRONGER SCREW THREADS IN WOOD PARTS** - Tired of stripping out threaded wing bolt holes? Try soaking the drilled hole with THIN CA before you tap the threads. Hit the hole with a spray of ACCELERATOR before you start the tap to be sure the glue is cured. Tap the hole, re-soak the threads, spray again with ACCELERATOR, and re-tap the hole. These threads will outlive the rest of the airframe.
- **EDGE JOINING SHEETS OF Balsa** - Layout a sheet of wax paper longer than the joint. Spray a wet coat of ACCELERATOR on the wax paper where the seam will be. Lay the balsa sheets together over the sprayed area. While holding the sheets together, lay a small bead of THIN CA on the joint. The ACCELERATOR on the waxed paper will keep the THIN CA from running down the backside of the joint. This greatly reduces the sanding to get smooth joints.
- **FOR MOUNTING CANOPIES** with CA glue try this trick. Spray a fine line of ACCELERATOR along the inside bottom edge of the canopy, position the canopy, and apply a thin bead of THICK CA to the outside of the seam. The THICK CA will be drawn under the edge of the canopy slow enough that the ACCELERATOR triggers the cure before it actually gets under the edge - no more fogging!!
- **WARNING TO PAINTERS!** On models that are to be painted, try not to use ACCELERATOR directly under any final color coats, particularly with epoxy paints. Many color paints will show a stain from the accelerator. CA glue and ACCELERATOR should be "buried" under a coat of good primer before the color coats are applied.

- **DEBONDER FOR CLEANUP** - After you've completed final assembly of a model finished with iron-on plastic film covering, clean up any CA glue smears with a rag wet with DEBONDER. The DEBONDER won't harm the plastic film. CAUTION: Do not use DEBONDER on painted models, decals, or canopies - it may dissolve or mark them!
- **CA GLUES ARE NOT FOR** - styrene or polystyrene foam; or "slippery" or "waxy" plastics like nylon, teflon, polyethylene, polypropylene, etc.

CAUTION: Some people may experience allergic reactions when exposed to fumes from cyanoacrylate glue. It is always recommended that CA glue, as well as all other glues, paints, thinners, and solvents, be used with adequate ventilation to carry fumes away. A fan is recommended. In many cases "foam friendly" or "odorless" CA may allow an allergic modeler to use a CA glue.

Warning! This Is Not A Toy!

Flying machines of any form, either model-size or full-size, are not toys! Because of the speeds that airplanes must achieve in order to fly, they are capable of causing serious bodily harm and property damage if they crash. IT IS YOUR RESPONSIBILITY AND YOURS ALONE to assemble this model airplane correctly according to the plans and instructions, to ground test the finished model before each flight to make sure it is completely airworthy, and to always fly your model in a safe location and in a safe manner.

The governing body for radio-control model airplanes in the United States is the ACADEMY OF MODEL AERONAUTICS, sometimes referred to as the AMA. The AMA SAFETY CODE provides guidelines for the safe operation of R/C model airplanes. While AMA membership is not mandatory, it is a good idea and we encourage all new R/C fliers to join the AMA. Membership in the AMA provides you with important liability insurance protection in case your R/C model should ever cause serious property damage or personal injury to someone else. For more information, contact:

ACADEMY OF MODEL AERONAUTICS
5161 East Memorial Drive
Muncie, IN 47302
Telephone: (765) 287-1256

WING CONSTRUCTION

Right Wing Panel

- Locate the six 1/4"x1/2"x36" balsa sticks. Cut two of the sticks to make four pieces 17-1/2" long. These are the spar doublers.
 - Using epoxy or THICK CA glue a spar doubler to one end of each of the 1/4"x1/2"x 36" balsa sticks. These are the main spars. Make sure the spars are kept straight while the glue is curing. Any bends or twists built in now are there to stay!
- Tape the wing plan down to the building board and cover it with waxed paper. Pin down one of the main spar assemblies in place on the plan, making certain that outboard end of the doubler is positioned at the last W-4 wing rib. Place the pins at an angle so they will not interfere with the spar webbing. Pin down a 1/4"x1/4"x36" balsa stick for the rear spar.
 - The 3/32"x2"x36" balsa trailing edge sheet is provided extra wide so that the forward edge can be cut straight with a long straightedge. Pin the bottom trailing edge sheet in place, aligning the front edge with the plans.
 - Place a scrap of 3/32" balsa near the main spar to accurately space the first four ribs up from the building board. This shim makes space for the center sheeting to be added later.
 - Position all the ribs (W-1 through W-5), main and rear spar webs and diagonal wing braces (0-1 and 0-2) on the front and rear spars. Do not glue now.

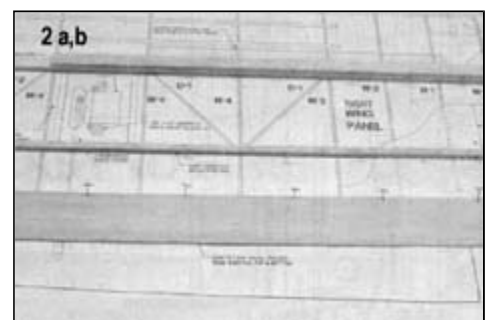
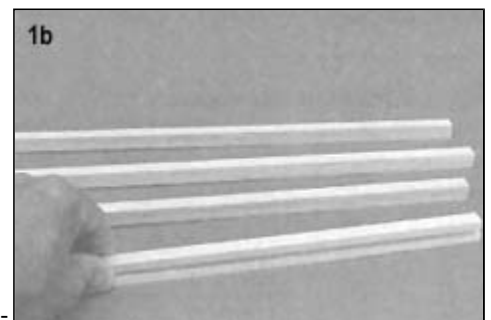

3.
 - a. Use the dihedral gauge side of the laser cut plywood dual tool to set the root rib (W-1) at the proper dihedral angle (2°). Glue the root rib to the spars and trailing edge sheet.
 - b. Glue all the previously positioned pieces.

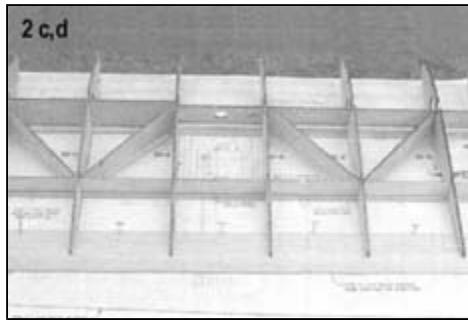

4.
 - a. Glue the pre-shaped 5/16"x5/16"x36" balsa leading edge to the leading edge of the wing ribs.
 - b. Cut and sand the dihedral angle on one end of the 1" x 1" angled shaped wing dowel support blocks. When the angle and length are correct glue the block in place between the two W-1 wing ribs and the leading edge.
 - c. With a X-Acto saw cut the two W-1 wing ribs in half where the laser cut guides are. This leaves space for the dihedral brace.
 - d. Glue in the top main spar and the top rear spar. It is critical that you get a good glue joint between the spar webs and the spars, both top and bottom. Use the dual tool to keep the W-1 rib at the correct angle.

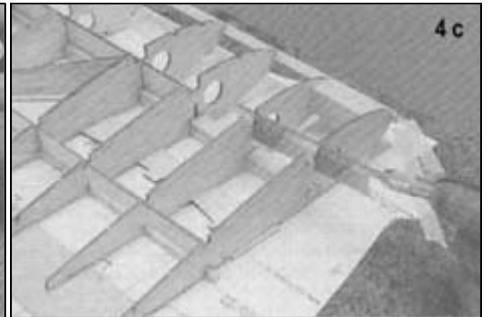
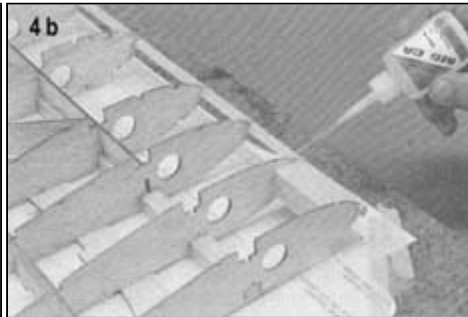

5.
 - a. Form an aileron servo lead tube by wrapping one of the supplied pieces of 5"x17-1/2" plain white paper around a dowel or a small broom handle. Slide the tube into the holes in the center wing ribs and glue in place. When the glue has cured cut the paper tube off at the second W-1 rib
 - b. Glue the pre-shaped 1/4"x1/2"x36" balsa trailing edge to the top of the trailing edge sheet and the ends of the wing ribs. Sand the top of the trailing edge flush with the rear edge of the ribs.
 - c. Cut and sand the dihedral angle on one end of the pre-shaped 1/2"x1" trailing edge fill-in blocks. When the angle and length are correct glue the block in place between the two W-1 wing ribs on the trailing edge sheet.



6. Trim one edge of a 3/32"x2"x36" balsa trailing edge sheet straight. For this step it is recommended that you apply SIG-Bond to the top of the trailing edge, and the ribs. Pin the trailing edge sheet and the trailing edge to the board to keep them straight until the glue cures.
 NOTE: Remove any pins from the structure that are located under the area where the top center sheets will be installed. If you leave out this step you may find it difficult to remove the wing from the building board after the next step.
 All of the wing center section sheets are cut from the 3/32"x4"x36" balsa provided.

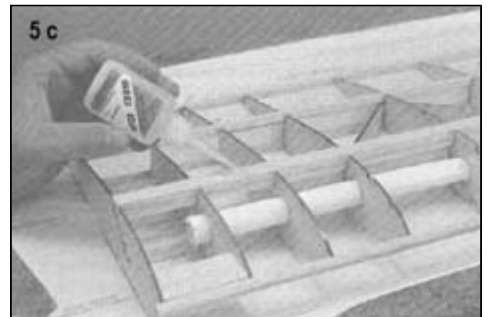

7.
 - a. Cut the top center piece that fits between the trailing edge sheet and the rear spar. Trim and sand the sheet to fit and glue it in place. SIG-BOND is recommended for gluing all of the center sheets to the ribs and spars as it is easier to sand the joints smooth.
 - b. Cut, fit and glue the rest of the top center sheets.
 - c. After the glue on the center section sheets has cured cut two 3/16"x1/2" slots in the top leading edge sheet at the W-3 wing rib. Glue the two 3/16"x3/16"x36" top forward spars in these slots and in the top of all of the ribs. When the glue has cured remove the wing panel from the building board.

IMPORTANT:

Now is the time to go back over every joint using MEDIUM or THICK CA. Don't be stingy here - the integrity of your wing depends upon strong glue joints. Glue BOTH sides of EVERY joint, even the aileron servo lead tube.

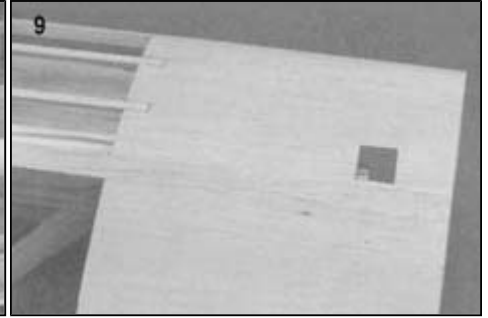

BE ABSOLUTELY POSITIVE THE SHEAR WEBS ARE BONDED TO BOTH THE TOP AND BOTTOM SPARS.

8. Cut, fit and glue a bottom center sheet between the trailing edge sheet and the rear spar.
9.
 - a. On both ends of the wing panel cut off and sand flush any excess materials.
 - b. Although the leading edge is pre-shaped, it should be blended into the leading edge sheet and the ribs with a long sanding block. Trim and sand the overhanging portion of the trailing edge sheets flush with the trailing edge.
 - c. Sand the top center sheets smooth. Cut a 3/4" square or round access hole in the top center sheet as shown on the plan.

Left Wing Panel

10. Repeat steps 2 through 9 to build the left wing panel. BE CAREFUL, DO NOT BUILD TWO RIGHT OR TWO LEFT WING PANELS.

Joining The Wing Panels

11.
 - a. Trial fit the two wing panels with the 1/8" laser cut plywood dihedral brace installed between the main wing spars. Be certain that the dihedral brace is not preventing the panels from making solid contact with each other at the center. If necessary, trim or sand the dihedral brace for a snug fit. The 2° dihedral per wing panel will automatically be built-in by the dihedral brace. If you want to check the angle, place the wing on the table so that one side sits flat, and the other is raised. The bottom of the raised wingtip should be about 1-7/8" above the surface of the table. A variation of up to 1/2" either way is acceptable and will not affect flight performance. Most important is to have a tight joint at the wing center with no gaps.
 - b. Use epoxy (either SIG 5-MINUTE or SLOW-CURE) to join the two wing panels. Apply glue generously to the end ribs and the dihedral brace. Work some glue into the slot in each wing root. Carefully slide the wing halves into place and hold in place with tape or pins. Wipe away any excess epoxy that oozes from the center joint with a paper towel or a rag dampened with isopropyl alcohol. Before the glue cures, make sure that the leading and trailing edges of both panels are perfectly aligned and that there is no built-in twist. Let cure.

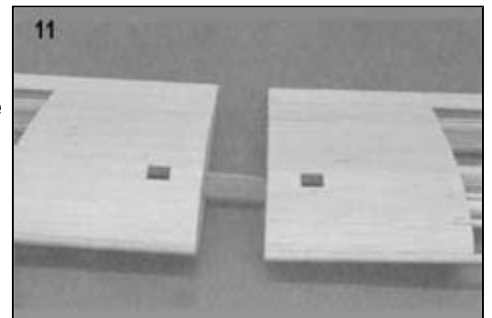

Completing The Wing

12.
 - a. While you still have access through the bottom of the wing, check the glue joint around the wing hold-down blocks and the dihedral brace. If necessary, apply another coat of epoxy to the joints.
 - b. Finish installing the bottom wing center sheets using pieces cut from 3/32"x4"x36" balsa.
 - c. After the glue on the center section sheets has cured cut two 3/16"x1/2" slots in the bottom leading edge sheet at the W-3 wing rib in both right and left wing panels. Glue the four 3/16"x3/16"x36" forward spars in these slots and in the bottom of all of the ribs. When the glue has cured, sand the forward spars flush with the tip ribs.
 - d. Glue the laser cut lite-ply wingtip to the outboard end of both wing panels.
 - e. Give the wing a final sanding. Sand just enough to take off any prominent high spots or bumps. Excessive sanding will distort the airfoil shape.

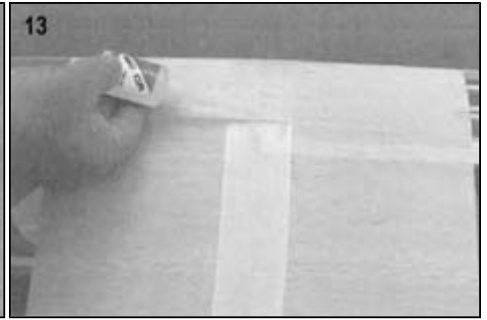
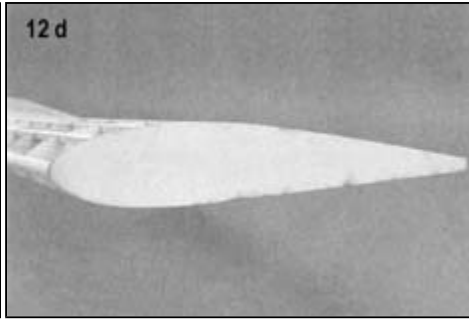
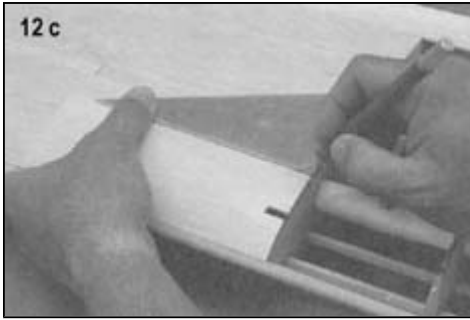

13. 2" wide fiberglass tape can be applied to the wing center joint (top and bottom) using the following method:

- a. Cut the tape to length - one piece from trailing edge, around the leading edge and back to the trailing edge.
- b. Lightly spray one side of the tape with a spray adhesive such as 3M "77".
- c. Center the tape on the wing center joint and press in place all the way around the wing.
- d. Flow THIN CA glue into the tape with a side-to-side motion. As the glass tape turns clear move down the tape until the complete length of the tape is glued. Remove any extra glue with a clean rag. Try not to flood the tape with excess glue as it will cure quickly, causing bumps and snags in the tape - bummer, more sanding.
- e. When the CA has cured, sand the joint lightly to remove any rough spots. Try not to sand into the fiberglass tape itself.

14. Glue the two laser cut 1/16" plywood wing hold down plates to the bottom of the wing, flush with the wing trailing edge and centered on the wing joint.

15. Sand the trailing edge of the ailerons round. Sand two 300 bevels on the leading edge of the ailerons with a sanding block. A pencil line drawn down the center of the ailerons will help keep the bevels symmetrical.

16. Tape the aileron to the wing with the outboard end of the aileron slightly past the wingtip. Sand the outboard end of the aileron flush and square with the wingtip.

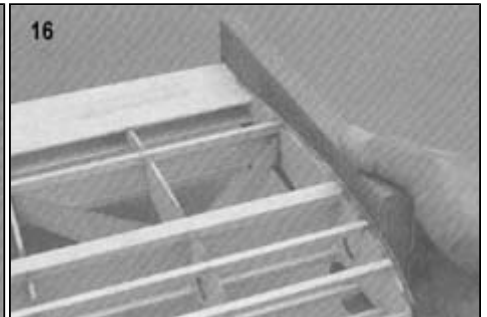
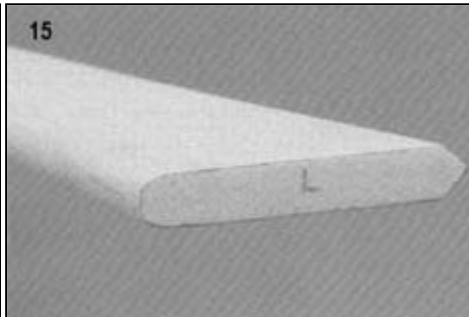
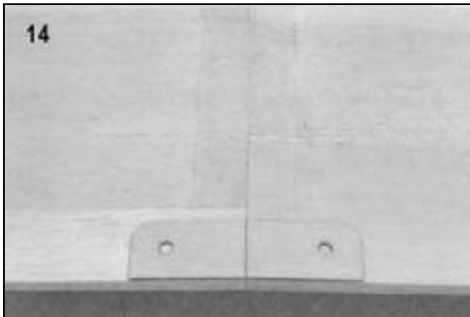

Aileron Servo Installation

17.
 - a. Cut four hatch rails from the special-cut 1/4"x1/2"x16" basswood stick provided in the kit. Glue the hatch rails flush with the bottom edge of the W-4 wing ribs in each wing panel. The hatch rails provide a seat for the aileron hatch and a flat surface for attaching the covering material.
 - b. Lay one laser cut 1/16" plywood hatch on the right wing panel rails and drill four 1/16" holes in the rails using the holes in the hatch as a guide. The hatch is held in place with four #2 x3/8" sheet metal screws.
 - c. Repeat step 17b. for the other hatch. Be sure to mark each hatch so you can tell later which hatch goes with which wing panel!
 - d. Cut four 3/8"x1/2"x7/8" pieces out of the 3/8"x1/2"x6" basswood to use as aileron servo mounts.
 - e. Place a 1/32" shim the size of the aileron servo on the workbench. Lay the servo down on the shim and stand the basswood mounts on end on the workbench and against the servo. Mark the location of the servo mounting screws and drill four 1/16" pilot holes for the screws.
 - f. Mount the servo to the basswood mounts using the grommets, eyelets and screws included with your radio.
 - g. Position the servo with mounts on the hatch cover and center the servo arm in the slot. Glue the servo mounts to the hatch cover. When the glue has cured remove the servo from the mounts and apply a second coat of glue to the mount and hatch cover.
 - h. Repeat steps 17e. through 17g. for the other aileron servo. Be careful, make a left and a right servo/hatch assembly.

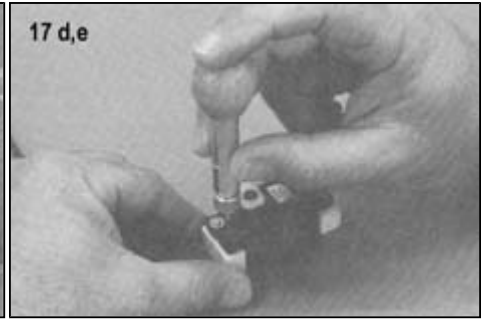
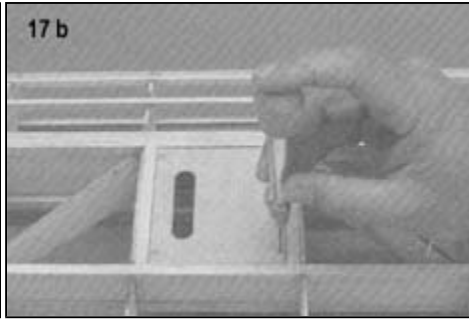
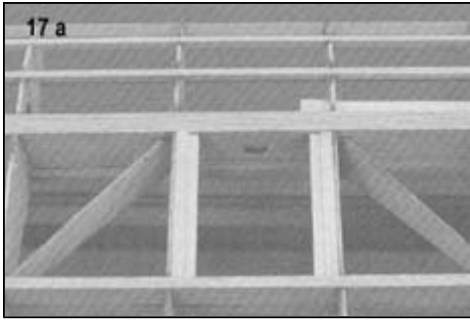

- 18.
- Mount one hatch/servo assembly in the wing. Using the plan as a guide make an aileron pushrod from a 4-40 x8" threaded rod, a 4-40 solder clevis, and a 4-40 threaded clevis. The actual length of the pushrod may vary slightly based on the shape and position of the aileron servo.
 - Connect solder clevis end of the pushrod to the servo arm. Swing the push rod towards the aileron, keeping it parallel to the ribs, and mark the position of the pushrod on the aileron.
 - The small nylon control horns, one right and one left, are used on the left and right ailerons, respectively.
NOTE: The aileron servo must be centered electronically before continuing.
 - Center the upright portion of the control horn on the aileron at the mark made in step b. Vertically line up the clevis attachment holes with the point of the leading edge bevel. Mark the position of the control horn mounting holes and drill a 5/64" hole at each mark.
 - Reinforce the control horn area by soaking the wood around the two holes with THIN CA. This will help keep the nylon horn from crushing the balsa when the control horn is installed later. When the glue has cured redrill the holes.

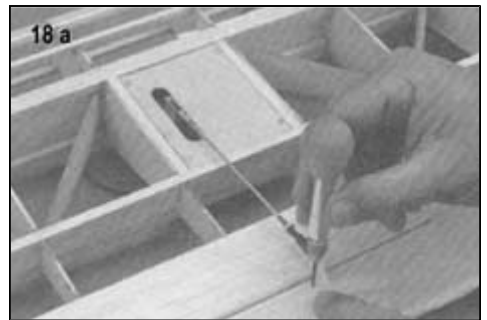
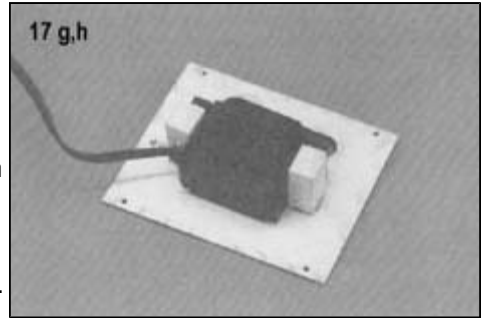

19. Repeat steps 18a through 18e. for the other aileron servo.



FUSELAGE CONSTRUCTION

Fuselage Subassemblies

Before starting the main part of the fuselage construction, there are four subassemblies that should be built. This will avoid interruptions during the flow of the fuselage construction.

NOTE: You need to have the engine that you will be using before proceeding.

20.
 - a. Mark the vertical center line and thrust line on the firewall (F1) using the cross section on the plan as a guide.
 - b. Mark and sand the bevel on the bottom of the firewall to match the angle shown on the plan.
 - c. Check the width of your engine and determine the spacing needed between the motor mounts. Using the lines on the firewall, locate the mounts, mark the location of the four holes on the firewall and drill an 11/64" hole at each mark.
 - d. Bolt the engine mounts loosely to the firewall with four 6-32 x 1" bolts and 6-32 blind nuts. Double check the location and spacing of the mounts. Tighten the bolts until the prongs of the blind nuts are started into the wood and holding. Remove the motor mounts from the firewall and seat the blind nuts with a hammer. Spread SIG KWIK-SET epoxy glue over the blind nuts to hold them in place. Be careful not to get any glue in the threads of the blind nuts.

21.
 - a. Using the side view of the plans as a guide, position the engine on the mounts so the propeller will clear the fuselage "cheeks" by 1/8" to a 1/4" and mark the engine mounting holes. Keep the engine as far back on the motor mounts as possible.
 - b. Remove the motor mounts from the firewall and drill the holes for the engine mounting bolts.
 - c. Bolt the engine to the motor mounts, the motor mounts to the firewall and mark the location for the throttle push rod to pass through the firewall. Allow clearance for the throttle pushrod connector included in the hardware package. Drill a 9/64" hole at this mark for the outer housing of the flexible cable.
 - d. Remove the engine and motor mounts from the firewall.

22. Using three 6-32 x 1/2" mounting bolts and 6-32 blind nuts, bolt the aluminum gear to the landing gear plate until the prongs of the blind nuts are in the plywood and holding. Remove the gear and seat the blind nuts with a hammer. Spread SIG KWIK-SET epoxy glue over the blind nuts to hold them in place. Be careful not to get any glue in the threads of the blind nuts.

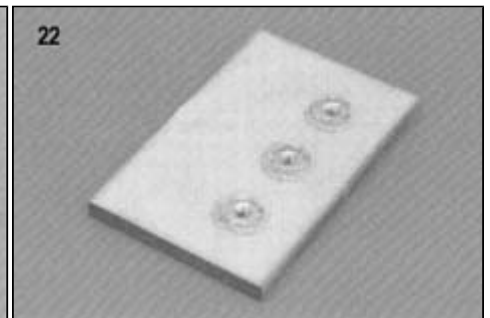
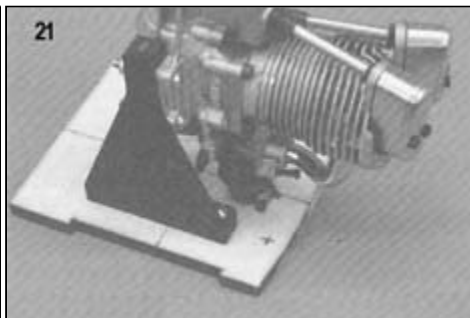
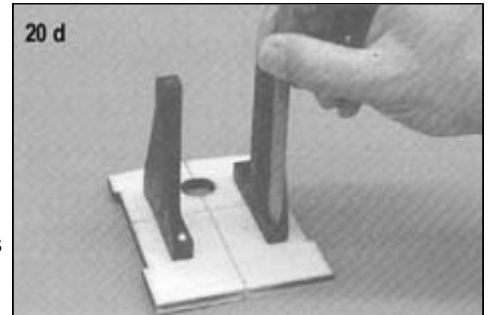
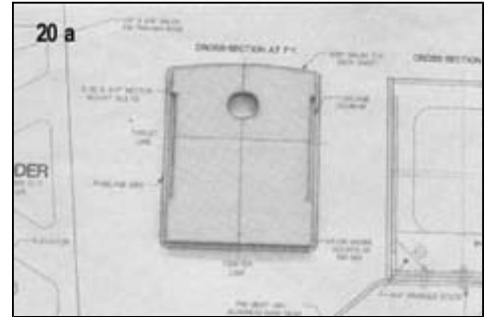

23. With the 1/4" holes in formers F-2 and F-2D aligned, glue the two formers together.

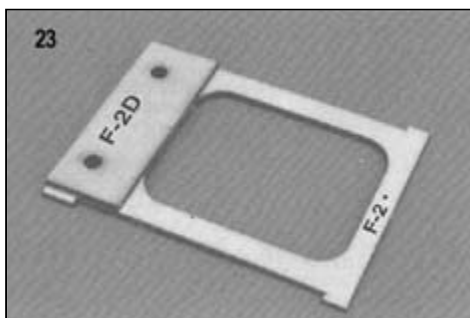

24. Glue the laser cut lite-ply tailwheel mount to the aft end of the fuselage bottom rear (FBR).

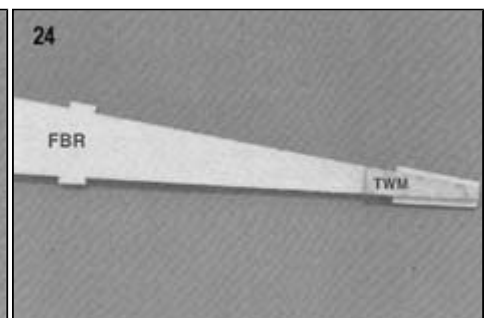

Fuselage Construction

- 25.
- Tape the fuselage plans to the work bench and cover with waxed paper.
 - The fuselage sides are assembled from two laser cut pieces. Align the fuselage front and rear pieces directly over the plan, check the fit of the parts, adjust if necessary and apply MEDIUM CA to the splice joint. Join another set of pieces for the other fuselage side.
 - Glue the laser cut fuselage doublers to the fuselage sides with THICK CA or KWIK-SET-SET-Set epoxy.
NOTE: Be sure to make one LEFT side and one RIGHT side.
- 26.
- Assemble all the fuselage formers (F-1 through F-6) into place between the fuselage sides. Put a rubber band around the fuselage at each former location to hold everything together.
 - Slide the laser-cut lite-ply Fuselage Bottom Rear (FBR) under the rubber bands until it snaps into proper location between the fuselage sides. Do the same thing for the laser cut lite-ply Fuselage Top (FT) and the laser-cut lite-ply Stab Support.
NOTE: The "Tee-Lock" tabs on the formers, FBR, and FT are made over-sized to protrude past the fuselage sides. These will be sanded off after the fuselage has been completely assembled.

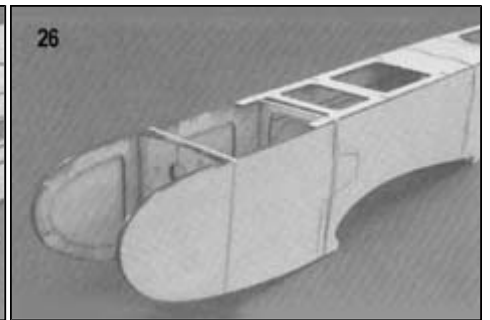
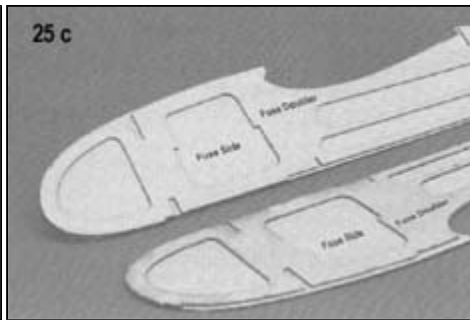
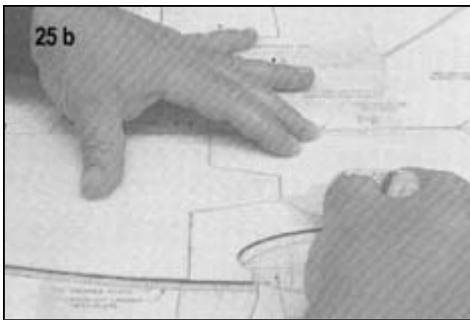

- 27.
- Place the fuselage over the top view on the plans to check the alignment. Even if some of the plywood is badly warped, the interlocking parts are designed to be self-aligning - warps in individual pieces should cancel out. If there are any persistent warps or twists, now is the time to fix it! Once the fuselage is glued, it can't be realigned. Double check that the opening at the back end of the fuselage is square with the fuselage top. If necessary, gently twist or push the parts in the desired direction and use masking tape to hold them there.
BUILDER'S TIP: To assist in keeping the nose section of the fuselage straight, you can install the laser cut lite-ply tank floor at this time but DO NOT GLUE IT IN PLACE.
 - Glue all of the parts in place, working from the inside of the fuselage first, using MEDIUM CA. Start with small patches of glue in the corners, checking the fuselage alignment as you go. Keep applying glue until the complete inside of the fuselage has been gone over once. Now go back and glue all of the joints on both sides. Leave the rubber bands and tape in place until all of the glue has cured completely.

28. Locate the laser cut lite-ply headrest (HR) on top of FT and glue HR in place. Use the 29° side of the Dual Tool to get the correct angle between HR and FT.

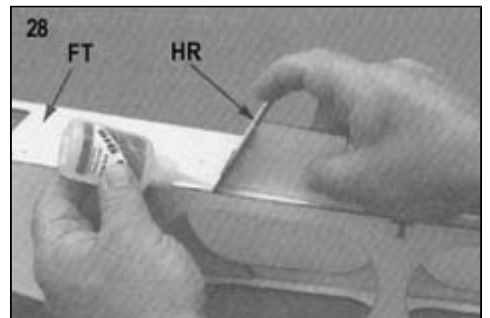

- 29.
- Position top formers F-4T and F-5T in the correct slots in FT and glue.
 - Glue the five 1/8"x5/16"x24" balsa fuselage stringers into the fuselage top formers and the headrest. Note that the top stringer and the two bottom stringers sit in notches in F-6, while the two middle stringers butt against the front face of F-6.
 - When the glue has cured, trim off the front of the stringers flush with the front of HR and the back of F-6. Save the scrap stringer material for later use.

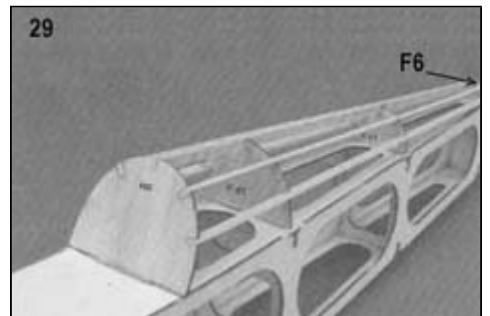

- 30.
- Install the landing gear plate to the fuselage by gluing it to the sides, the doublers, and the bottom of F-2. Don't be stingy with the glue - you may find yourself picking up the landing gear as a separate piece after a hard landing.
 - Glue the fuselage bottom front (FBF) in place using MEDIUM or THICK CA. Be sure to glue the joint between FBF and the landing gear plate from inside the fuselage.

NOTE: The hole in FBF is provided to serve as an oil drain hole as well as a convenient place to route the vent line from the fuel tank and/or the breather line from the crankcase of a four-stroke engine.

- 31.
- Cut two 1-15/16" pieces from the 3/4" balsa triangle stock to reinforce the landing gear plate fuselage joint. For each piece; bevel the rear edge to match former F-2, notch to clear the blind nuts on the backside of the landing gear plate and glue in place with MEDIUM CA.
 - Cut two 4-1/2" pieces from the 3/4" balsa triangle stock to reinforce the firewall (F-1). For each piece; bevel the bottom edge to match the fuselage bottom, notch to clear the blind nuts on the back of F-1 and glue in place with MEDIUM CA.
 - After the glue has cured on all four pieces of triangular stock reglue each piece with THIN CA to insure complete penetration of glue into the joint - loss of the landing gear plate or the firewall is generally a disaster.

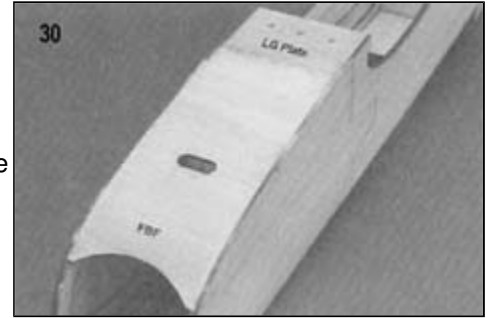

- 32.
- Install the tank floor. Make sure it is seated down on the fuselage doublers and is against the firewall before gluing it in place.
 - Now is a good time to assemble and install the tank. Block the tank in position with pieces of balsa, foam rubber or styrofoam. If the recommended tank size is used (Dubro 12 ounce) the final installation can be completed after the airplane is covered or painted. If you use a tank other than the one recommended, it may not be possible to install the tank later on, so do a complete installation now.
 - Remove the tank and glue in the nylon tubing for the throttle pushrod. Slide the tank back in position, insert the steel cable throttle pushrod and check for any binding. Correct any problems now as it will be hard to get to this area later on.

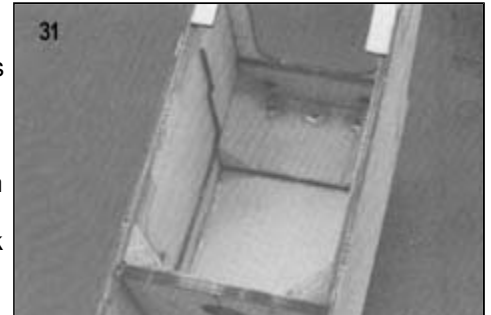

- 33.
- Glue the balsa top deck formers T-1, T-2, and T-3 into the correct slots in FT. Note that T-1 is placed in front of and slightly lower than the top of FT.
 - Bevel the top edge of the fuselage sides with a sanding block to match the formers to provide a firm seat for the fuselage top deck. Notice that the angle between the top deck and the fuselage sides varies along the entire length. Use the top deck formers as a guide to the sanding angle. Don't worry about perfection - a few swipes with a sanding block on each side should do the trick.
 - Tape the laser cut balsa top deck in place. You should apply some warm water to the upper surface of the top deck to make it easier to bend into shape and to prevent it from cracking. Apply MEDIUM CA to the top deck from the inside as much as possible. When the CA has cured, remove the tape.

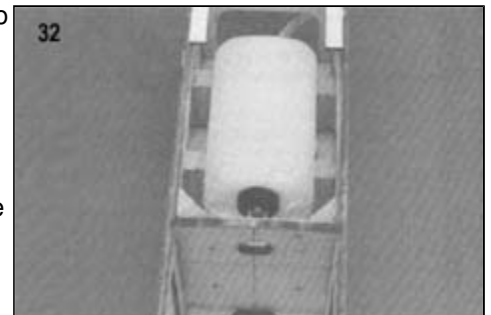

- 34.
- The two 3/4"x3/4"x1-1/2" basswood wing hold-down blocks key into the pre-cut notches in the fuselage doublers. Temporarily tape the wing in place on the fuselage and check the fit of the blocks by working through the lightening holes in the rear of the fuselage. The blocks should seat firmly against both the fuselage side and the top surface of the wing.
 - When satisfied with the fit of the wing hold-down blocks glue the blocks in the fuselage with medium CA.
 - Cut two 1-3/8" lengths of 3/4" balsa triangle stock for reinforcements for the wing-hold down blocks. Bevel the back edge to match former F-3 and glue the triangle reinforcements to the top of the hold-down blocks, the fuselage doublers and fuselage former.
 - Reglue all of the wing hold-down blocks and reinforcements with THIN CA. It's really embarrassing to have the wing fly off in an outside loop.

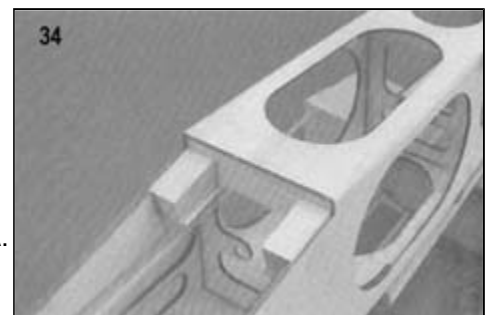

35.
 - a. Locate the two .270 o. d. x 36" nylon outer push rod tubes (black). Roughen the last 4" on both ends of each outer tube with sandpaper to aid glue adhesion.
 - b. Slide the outer push rod tubes forward through the pushrod exit slots in the fuselage sides and the holes in the formers. Continue sliding the tubes forward as far as you can, they will be cut to length later.
 - c. Apply CA to the outer tubes at the pushrod exit slots - from both the inside and the outside of the fuselage. With either glue or glue and filler fill the area around the tube where it exits the fuselage. Now glue the tube to each former front and rear.
 - d. Use a single-edge razor blade to rough trim the outer push rod tubing flush with the outside surface of the fuselage. Sand the pushrods flush with the sides of the fuselage.

36. Check the fuselage for joints that could use another application of glue. Fill any gaps at the Tee-Lock tabs and slots with MEDIUM CA. The fuselage should now be ready for final sanding. With 80 grit sandpaper and a block, sand the tee-lock tabs flush with the fuselage sides and round the bottom edges of the fuselage and the corners of the balsa top deck. Switch to 220 or 360 grit for the final sanding.

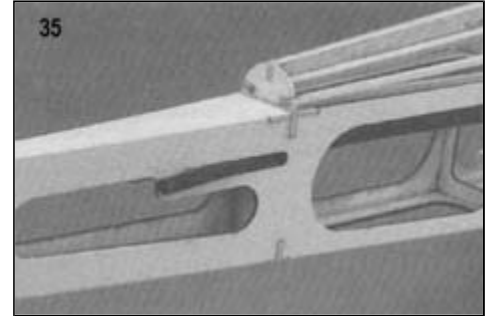

Mounting The Wing To The Fuselage

NOTE: You must have a completed wing before proceeding.

37.
 - a. Careful alignment is particularly important, so take your time and be very accurate when making alignment marks and taking measurements. Measure the span of the wing and mark the center of the leading and trailing edge of the bottom of the wing. I know, you built both wings identical, but you'd be surprised how often one wing turns out to be just a 'little bit' longer than the other. Measure and mark the center of the fuselage at the front and rear of the wing saddle.
 - b. Place the wing on the fuselage and check the fit. If everything was properly built the wing should fit into the opening without any gaps. If the wing does not fit properly, now is the time to sand off any bumps or fill any hollows to match the contour of the wing. **DO NOT CHANGE THE INCIDENCE OF THE WING.**
 - c. Tape the wing to the fuselage and take measurements from the wing tip to the tail of the fuselage. Both measurements should be the same. If not, rotate the wing, keeping the leading edge in place, until both measurements are identical. Remark the trailing edge to reflect the correct position. Remove the wing from the fuselage.

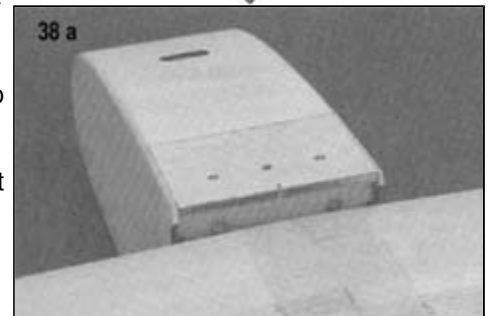
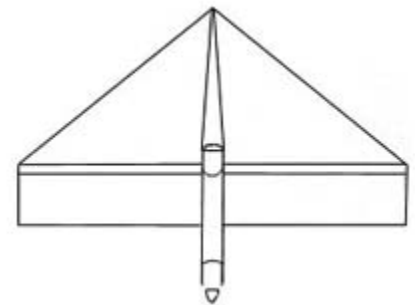

38.
 - a. Locate the two 1/4" diameter x 1-3/4" wing dowels and sharpen one end of each to a point, keep the point symmetrical and centered. Push the dowels into the holes in F-2 so that only the points remain sticking out into the wing opening. Slide the wing into position, making sure it is centered on and square to the fuselage. When you remove the wing, there should be two small indentations in the leading edge.
 - b. Drill 1/8" holes through the leading edge at the indentations. Enlarge the holes to 1/4". Extend the 1/4" hole completely through the dowel support block. It is important to keep the drill aligned with the wing center line.
 - c. Remove the wing dowels from F-2. Put a piece of wax paper over the face of F-2 and reinsert the dowels, forcing them through the wax paper. Push the dowels in only 3/8", leaving most of their length exposed.
 - d. Trial fit the wing in position, sliding it onto the dowels. Check to see that the wing seats properly on the fuselage. If not, slowly enlarge the holes in the leading edge of the wing until it does seat properly.

39. When satisfied with the fit of the wing and wing dowels, coat the inside of the holes in the leading edge with epoxy. Slide the wing back into position on the dowels. Hold the wing in place until dry, then remove the wing and fill any gaps around the dowels with another application of glue.

40.
 - a. Fit the wing in place on the fuselage and check its alignment one last time. When you are satisfied that the wing is aligned correctly, tape it so that it can't move.
 - b. Drill #7 (or 13/64") holes through the wing using the laser cut holes in the wing hold-down plate as a guide. Keep the drill perpendicular to the bottom surface of the wing so the heads of the nylon bolts will seat flush against the plywood plates.
 - c. Remove the wing and apply a few drops of THIN CA to the holes. When the CA has cured, tap the wing hold-down blocks with a 1/4-20 tap. Apply a few drops of THIN CA to the holes to strengthen the threads. After the CA has cured, clean up the threads by re-tapping the holes.
 - d. Enlarge the holes in the wing to 1/4" to pass the nylon wing bolts.

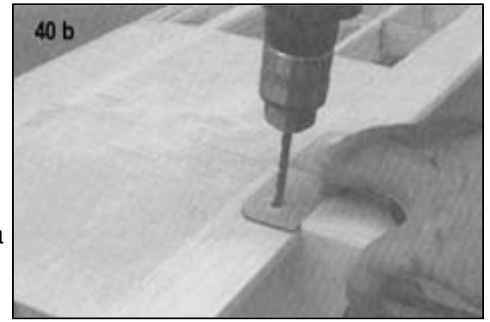

Stabilizer And Elevator

41.
 - a. Tape the stabilizer plan to the building board, and cover it with waxed paper.
 - b. Glue and pin down the 1/4" laser cut balsa pieces (S-1, S-2, S3, and S-4) over the plans.
 - c. Cut the six 1/4" x 3/8" balsa ribs and glue in place with THIN CA.
 - d. When the glue has cured remove the frame from the building board and fill any gaps in the stabilizer frame with MEDIUM CA.

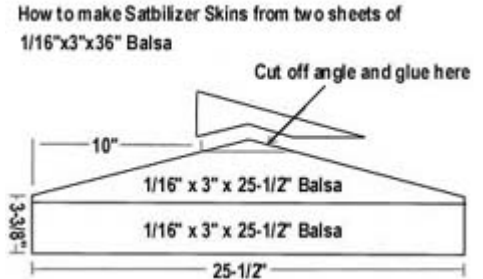

42.
 - a. The stabilizer is sheeted on both sides with 1/16" x 3" x 36" balsa. Assemble the balsa sheets per the diagram on a piece of waxed paper with THIN CA to make two stabilizer skins. If the waxed paper is sprayed with accelerator before gluing the skins the CA will not wick between the waxed paper and the balsa skins. The remaining balsa sheets will be used for the fin skins.
 - b. Separate the skins from the waxed paper and sand the joints smooth BEFORE attaching them to the stabilizer. Sanding the skins after attaching them to the framework will result in a "ripple effect".
43.
 - a. Sand the top and bottom of the stabilizer frame to smooth out the glue joints. Also sand the ends of the leading and trailing edges.
 - b. Apply THICK CA or SIG-BOND to one side of the stabilizer frame, place it over the stabilizer skin, press in place and immediately pin the assembly down to the building board to keep it flat while the glue cures.
 - c. Repeat for the opposite skin and allow the glue to cure.
 - d. Sand the sheets flush with the stabilizer frame all around. Round the leading edges with a sanding block and sand a small flat spot at the center "point" of the stabilizer so that it will seat correctly against former F-6.
44.
 - a. Locate the two pre-cut 3/8" balsa elevators and sand the trailing edges round. Sand two 30° bevels on the leading edge of the elevators with a sanding block. A pencil line drawn down the center of the elevators will help keep the bevel symmetrical.
 - b. Use the plans to mark the elevators for the position of the 1/8" diameter music wire elevator jointer. Drill and groove the leading edges to accept the elevator jointer. Sand the jointer wire and wipe it clean before gluing it to the elevators with KWIK-SET Epoxy. Keep the leading edges of both elevators aligned as the glue cures.
 - c. Wrap two short pieces of 2" glass tape over the 1/8" jointer wire and glue in place with THIN CA.
 - d. Temporarily tape the elevators to the back of the stabilizer. Use a sanding block to match the ends of the elevators to the stabilizer.

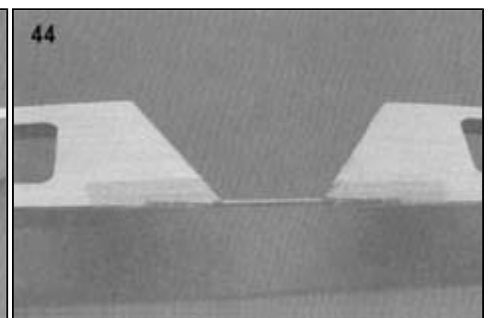
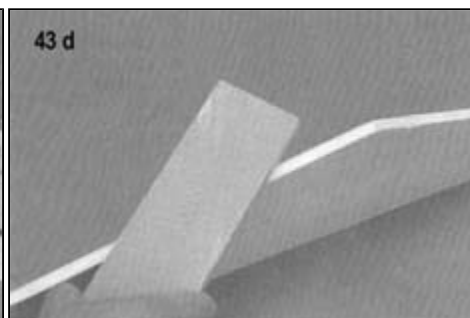
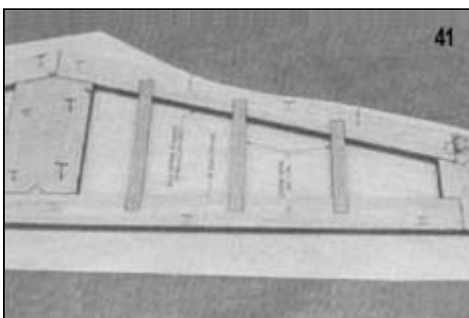

Fin And Rudder

- 45.
- Tape the fin plan to the building board, and cover it with waxed paper.
 - Glue and pin down the 1/4" laser cut balsa pieces (FN-1, FN2, FN-3, and FN-4) over the plans.
 - Cut the two 1/4" X 3/8" balsa ribs and glue in place with THIN CA.
 - Glue the 1/4" x 5/8" fin trailing edge to the fin frame.
 - When the glue has cured remove the frame from the building board and fill any gaps in the fin frame with MEDIUM CA.
- 46.
- The fin is sheeted on both sides with 1/16" x 3" x 10-1/2" balsa left over from sheeting the stabilizer. Assemble the balsa sheets per the diagram on a piece of waxed paper with THIN CA to make two fin skins. If the waxed paper is sprayed with accelerator before gluing the skins, the CA will not wick between the waxed paper and the balsa skins.
 - Separate the skins from the waxed paper and sand the joints smooth BEFORE attaching them to the fin frame. Sanding the skins after attaching them to the framework will result in a "ripple effect".
- 47.
- Sand both sides the fin frame to smooth out the glue joints. Also sand the ends of the leading and trailing edges.
 - Apply THICK CA or SIG-BOND to one side of the fin frame, place it over the fin skin, press in place and immediately pin the assembly down to the building board to keep it flat while the glue cures.
 - Repeat for the opposite skin and allow the glue to cure.
 - Sand the sheets flush with the fin frame all around. Round the leading edge with a sanding block.

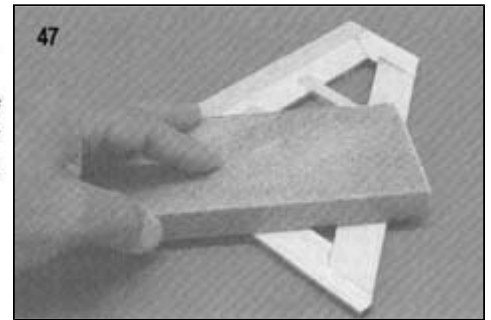
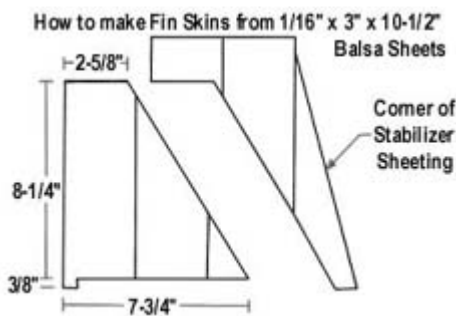
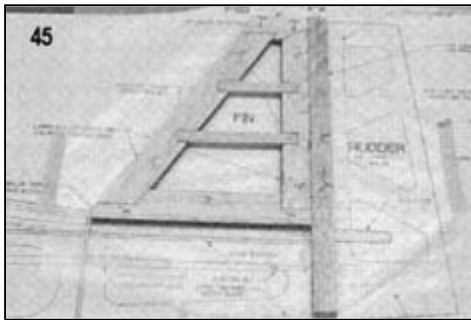

- 48.
- Temporarily pin or tape the stabilizer to the fuselage. Trial fit the fin in the fuselage and on top of the stabilizer. It may be necessary to trim the length of the fin trailing edge to allow the base of the fin to set on top of the stabilizer. Leave the fin in place until after the tailwheel has been fitted.
 - Round off the trailing edge and the bottom of the laser-cut 3/8" balsa rudder. Sand two 300 bevels on the leading edge of the rudder with a sanding block. A pencil line drawn down the center of the rudder will help keep the bevel symmetrical.
 - Cut a slot in the bottom of the rudder to accept the tailwheel wire.
- 49.
- Align the bottom edge of rudder with the fuselage bottom and tape in place.
 - Trial fit the tailwheel assembly. Adjust the bends in the wire and the slot in the bottom of the rudder as necessary until the nylon tailwheel bracket seats properly on the fuselage bottom and the tailwheel wire is aligned with the rudder; i.e., flat in the slot and in line with the rudder.
 - When satisfied with the fit of the tailwheel assembly remove it from the fuselage and rudder. Prepare the washers and wire for soldering.

BUILDER'S TIP:

#2 flat washers are included in the kit to act as retainers for the tailwheel and as a support to transfer the loads from the tailwheel wire to the tailwheel bracket. You can use 3/32" wheel collars (not included), but the soldered washers give a more "finished" look and are more reliable.

The secret to successful soldering is cleanliness. Sand the washers and the wire where the washers are to be soldered and then wipe everything clean with alcohol before attempting to solder the washers to the wire.

50. a. Solder the tailwheel wire support washer in place first. This washer transfers the load on the tailwheel wire to the bracket without splitting the bracket. If the wire is clamped upside down in a vise the washer will lay in the correct position. Before soldering the washer check the spacing between the bracket and the wire. The wire should protrude 1/8" below the bracket to lay flush in the groove in the rudder. Place a thin cardstock spacer between the wire and the bracket to minimize the heat transfer during soldering. Solder the washer with a minimum of heat to avoid damaging the tailwheel bracket.
- b. To hold the inner tailwheel washer in place for soldering slide a small, short piece of silicon fuel tube over the wire. Solder the #2 washer close to the bend in the wire to keep the wheel centered and free turning.
- c. When the wire has cooled, place the tailwheel on the wire, place a thin cardstock spacer on the wire, place the outer washer on the wire and solder the washer in place. Wash all the flux off the wire and washers with alcohol and/or hot water to keep everything from rusting together.
- d. Sand and wipe clean the top of the tailwheel wire and glue it in the bottom of the rudder with SIG KWIK-SET epoxy. Tape the nylon tailwheel bracket to the fuselage to maintain alignment until the glue cures.
- e. Allow the epoxy to cure, then reinforce the tailwheel area with a 2-1/2" long piece of 2" wide fiberglass tape applied with SIG KWIKSET epoxy. When the glue has cured, remove the rudder along with the entire tailwheel assembly from the fin and fuselage.

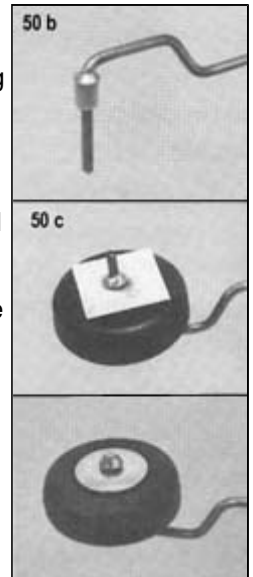

NOTE: The tailwheel bracket will be attached to the fuselage during final assembly.

51. a. The balsa tail fairing blocks can now be glued to the fuselage using the stabilizer and the fin to position them accurately. Cut two 3" lengths of 1/2" balsa triangle stock to serve as tail fairing blocks. Make sure your fin is centered on the fuselage (as viewed from above), then carefully glue the fairing blocks to the back of F-6 (not the tail surfaces). Gently slide the fin and stabilizer off the fuselage and apply a second coat of glue to the front of the fairing blocks.
- b. Temporary scrap spacers are used to support the fairing blocks during shaping. Spot glue a 3/8"x3/4"x2" balsa spacer (not included) to the stab support centered under the fairing blocks. Glue a scrap piece of 3/16"x3/8" balsa (not included) to the top of the spacer between the fairing blocks. Finally, spot glue the fairing blocks to the spacers.
- c. Carve and sand the fairing blocks to blend in smoothly with F6 and the fuselage stringers. Use a sanding block with one end wrapped with paper to protect the stringers from the sandpaper. Leave the spacers in place until the fuselage is covered. This will help prevent damage to the fairing blocks.



FINISHING AND FLYING

General Covering Instructions

We recommend that you cover the wing, fuselage, tail surfaces, and control surfaces individually before hinging and final assembly. The individual parts are much easier to handle and will suffer far less hanger rash.

The Four-Star 60 prototypes were covered with SIG SUPERCOAT iron-on plastic film. SIG SUPERCOAT is ideal for sport models because it's lightweight and easy to apply.

The following instructions provide advice and procedures specific to covering the Four-Star 60 with either SIG SUPERCOAT or SIG KOVERALL. If another brand of covering material is selected, be sure to read the manufacturer's directions and follow them carefully.



Surface Preparation

A good covering job starts with good surface preparation. Regardless of what type of covering you choose, it won't hide poor workmanship. Fill any small surface gaps or dents with a lightweight filler or spackling paste. Sand every piece of the model; first with 220-grit sandpaper, then again with 360 or 400-grit sandpaper.

The engine compartment and the cockpit require preparation before general covering is started. Since it's too difficult to apply covering material to the engine compartment, it must be fuel-proofed with several coats of clear dope or two coats of polyester resin, sanding between coats. Finish off the engine area with a few coats of colored SIG SUPERCOAT Dope. Most of the SUPERCOAT plastic iron-on films have a matching SIG SUPERCOAT Dope color.

Covering With Sig Supercoat Iron-On Plastic Film

You will need at least three rolls of SUPERCOAT to cover the Four-Star 60. If a multi-colored finish is wanted, more than three rolls of SUPERCOAT may be needed.

Covering The Wing

Begin the wing by covering the wingtips and plywood hold-down plates. On the wingtips, run the covering material "around the corner" $3/16"$ to $1/4"$. Later, when the main top and bottom covering pieces are applied, there will be an overlap that is easily trimmed and will leave a nearly invisible seam. Extend the covering material $3/16"$ to $1/4"$ past the outside edges of the hold-down plates to provide an area for overlap and sealing.

Cover the main portion of the wing in four pieces, starting with the bottom. Trim the covering off at the top of the leading and trailing edges. Cover the top of the wing last so all of the seams will be on the bottom or back edges. The top covering should overlap the full width of the leading edge and the vertical section of the trailing edge.

Wait until both the top and bottom pieces of covering material have been sealed completely around their edges before shrinking the large open areas between the ribs. Alternate between the top and the bottom surface to avoid uneven shrinking which could cause a warp. Keep the heat gun moving at all times as it's possible to burn a hole in the covering. If the covering material starts to "balloon up", put a small pin hole in the bottom of each rib bay to allow the expanding air to escape.

After all of the covering is tight, bond the covering material to all of the spars and ribs by going over them with the sealing iron. This will maximize the torsional stiffness of the wing.

Cut an "X" pattern at the hatch opening on the bottom of each wing panel and iron the overhanging material to the spars and hatch rails. Trim off the excess after all edges are sealed. Don't forget to cover the plywood hatches - for a neat looking job, wrap the covering around the edges of the hatches $3/16"$ to $1/4"$.

Covering The Fuselage

The fuselage should be covered with six pieces in the order described below:

- Fuselage Bottom - 2 pieces, front and rear
- Fuselage Top - 2 pieces, top deck and stringers
- Fuselage Sides - 2 pieces, left and right

All seams should overlap $3/16"$ to $1/4"$. When covering solid wood surfaces like the front of the fuselage sides, better results can be obtained by starting at the center and working toward the outer edges. This avoids trapping air under the covering.

The trickiest part of covering the fuselage is the stringer area behind the cockpit. Cut a piece of covering wide enough to go completely over the top of the fuselage and long enough to overlap the headrest and the tail fairing blocks. Start by applying one edge of the covering to one of the fuselage sides, overlapping $3/16"$ to $1/4"$ onto the sides. Drape the material to the other fuselage side, pull tight, seal the covering to the side and trim off the excess leaving $3/16"$ to $1/4"$ overlap.

BUILDER'S TIP:

When trimming material at overlaps be especially careful not to cut through the layer of covering underneath. Laying a small strip of plastic or cardstock under the trim line makes it much easier to trim and eliminates the worry of cutting the covering underneath.



Go back over the side seams with the iron and then seal the covering to HR at the front as well as F-6 and the tail fairing blocks at the rear. Trim away the excess covering at the rear flush with the edges of the fairing blocks and F-6. At the front, leave a 1/8" overhang to the front of HR. Fold the overhang to the front of HR and seal down. Use a heat gun or iron to shrink the material tight over the stringers. Think about covering or painting the headrest (HR) and the cockpit floor with another color like grey or black, to set off the cockpit area.

Covering The Tail Surfaces And Ailerons

The stabilizer, elevator, fin, rudder, and ailerons should each be covered with two pieces of material - bottom first, then top. Iron the material from the center out to avoid trapping air bubbles. Be sure to cover the back edge of the fin trailing edge all the way to the bottom.

Covering With Sig Koverall And Dope

KOVERALL is a polyester-based heat-shrinkable, synthetic fabric much like the covering used on full-scale aircraft, only lighter. Its toughness and relatively low cost make it ideally suited for sport models or giant scale aircraft. One large package of KOVERALL (48" x 5 yards) is plenty of material to cover most models. It can be applied to the structure using dope or SIG Stix-it, a heat-activated adhesive.

Surface Preparation

Whichever application method is used, you should first brush two coats of clear dope onto the framework wherever the covering material makes contact - even the edges of the wing ribs. If dope is going to be used for the entire finish, apply SIG LITE-COAT (low-shrink butyrate dope) for the first two coats. If enamels or epoxy colors are going to be used, apply SIG NITRATE dope for the first two coats. Lightly sand after each coat to remove any raised grain or fuzz.

Applying Koverall With Dope

The bottom of the wing panel is a good place to start covering. Cut a piece of material about an inch larger all around the panel, with the grain running spanwise. The grain of KOVERALL runs parallel to the finished edge. Lay the KOVERALL on the wing, pulling out any major wrinkles. KOVERALL has considerable shrink when heated, so there's no need to worry about packaging fold creases because they will disappear when the KOVERALL is shrunk. Pull the KOVERALL snug across the root of the wing and brush clear dope along the tight edge. The dope will soak through the fabric, adhere to the dope already on the framework and lock the fabric in place. When the dope has 'set' move to the wingtip and snug up the fabric spanwise and chordwise and brush clear dope through the fabric. Repeat the tensioning, doping sequence all around the rest of the wing. Allow the dope to dry before trimming off the excess material with a sharp razor blade. Check for any rough edges or places that are not stuck down properly and apply more dope. Let the dope dry thoroughly before applying the next piece of fabric. This process continues until all the parts are covered. Any parts that are going to be glued in place at a later time should have the glue areas masked off to preserve the bare wood and enhance the adhesive properties of the glue.

Applying Koverall With Stix-It

Directions for using STIX-IT are on the can. The basic procedure is to apply STIX-IT around the edges of the framework where you want the covering to attach. When dry, the fabric can be ironed-on around the edges where the STIX-IT was applied.

Shrinking And Sealing Koverall

After both sides of a surface are covered, shrink the KOVERALL evenly with an iron or heat gun. It is possible to 'burn' KOVERALL with too much heat, yet not show any damage. Heat the KOVERALL only enough to get the tautness needed. It is possible to badly warp lighter structures because of the high level of shrink obtainable.

The fabric is now ready to be sealed with clear dope. The dope that you apply to the top of the fabric will soak through and bond with the dope underneath, firmly cementing the KOVERALL in place.

Thin the dope until it brushes on easily and flows out smooth (25% to 30% thinner.) The first coat should be applied sparingly to avoid puddles underneath the fabric. The second coat will seal most of the pores of the KOVERALL, from then on running through will not be a problem. Sand the edges of the KOVERALL very lightly with fine sandpaper after the second coat is dry. It may take three to five coats of clear dope on the KOVERALL before going to color, depending on how heavy the coats are. The type or quality of finish desired will determine when enough clear dope has been applied. Keep in mind that weight can build up fast when painting! Generally, don't bother trying to completely fill the weave and avoid using heavy sanding sealer or primers. The goal is to hide the seams and provide an even base for the color paint.

Finishing With Supercoat Dope

Complete assembly of the model before applying the color coats to the model. The best results can usually be obtained by applying the color coats of dope with spray equipment. Thin the dope for spraying by mixing in an equal amount of SIG SUPERCOAT DOPE THINNER or SIG RETARDER. Apply two, or three coats, starting with the lighter color, followed by the darker trim colors. Mask off the trim scheme with low-tack drafting tape or 3M automotive striping tape. Seal the edges of the tape with clear dope (applied with a small brush) before applying the trim colors. A final coat or two of clear dope over the color coats will add a nice gloss to a finish that is rugged and easy to repair.

Applying The Decals

The supplied decals can be used over any type of finish as long as the surface is clean. If needed, replacement decals are available from SIG (order SIGDKM273A, SIGDKM273B, and SIGDKM273C).

Cut out the decals with sharp scissors, leaving about 1/32" to 1/16" of clear at all edges, rounding the corners as you cut. Wet the surface on which the decal will be placed with soapy water. Place the decal on the model and squeegee the water from underneath the decal with a balsa paddle. This procedure allows time for repositioning and prevents air from being trapped under the decal. Allow several hours to dry.

Installing Easy Hinges

52.
 - a. With a No. 11 X-Acto blade, cuts slots approximately 1/2" in depth and slightly wider than the hinges. Cut six slots in the stabilizer and six matching slots in the elevators at the locations shown on the plan.
 - b. Place a small straight pin in the middle of each hinge.
53. Insert EASY HINGES halfway into the stabilizer slots, the pins will provide automatic location. **DO NOT GLUE THE HINGES!** Starting at one end slide the elevators onto the hinges at an angle, one at a time. It's next to impossible to start all of the hinges at once. Don't be concerned if the hinges aren't perfectly straight or centered in the slots, they'll work regardless of their final position. Remove the straight pins.

54.
 1. To set the hinge gap, deflect the elevators to the maximum amount needed. For best control response, the gap should be as small as possible but big enough to allow full movement of the control surface without binding.
 2. EASY HINGES were designed to use THIN CA for maximum glue penetration. Place three or four large drops of THIN CA directly onto the hinges in the gap. The glue will wick into the slot as it penetrates both the wood and the hinge. Continue this process, gluing the same side of all of the hinges. Turn the stabilizer over and repeat the gluing process on the other side of each hinge. Set the stabilizer/elevator assembly aside while the glue cures - about an hour.

55.
 - a. Repeat steps 53 and 54 to attach the ailerons to the wing. Use six hinges in each aileron.
 - b. The rudder is hinged in the same manner as the other control surfaces, but it's easier to permanently install the rudder hinges **AFTER** the fin has been glued to the fuselage. Cut matching slots for four hinges while the fin and rudder are easy to handle.

56.
 - a. Mark a centerline on top of the stabilizer, making sure that the centerline is perpendicular to the trailing edge of the stabilizer. Pin the stabilizer to the fuselage, mount the wing to the fuselage and measure from the trailing edge of the wing to the trailing edge of stabilizer. Both measurements should be the same. If there is any difference rotate the stabilizer until the measurements are identical.
 - b. When satisfied with the alignment, draw cut lines on the bottom of the stabilizer at the fuselage sides, and on the top of the stabilizer at the tail fairing blocks. Remove the stabilizer and cut away the covering between the lines, exposing the bare wood underneath. Use a sharp knife to cut the covering material - try not to cut into the balsa sheet. Use the same method to expose the area under the tail fairing blocks.
 - c. Permanently glue the stabilizer to the fuselage using KWIK-SET epoxy. Recheck the stabilizer alignment and adjust as necessary before the glue cures.

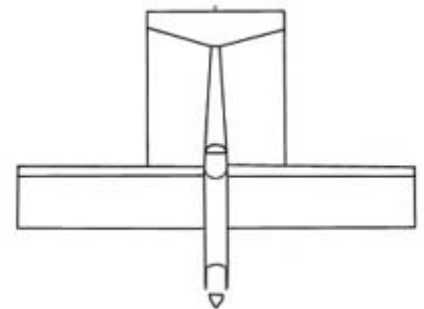

57.
 - a. Cut away a 3/8" wide strip of covering from the center of the stabilizer where the fin is to be glued. Also, remove the covering material from the front of the fin where the tail fairing blocks make contact.
 - b. With KWIK-SET epoxy glue the fin to the top of the stabilizer, using a triangle to check its alignment before the glue cures. Make certain that the fin trailing edge is firmly glued between the fuselage sides.

58. a. Repeat steps 53 and 54 to attach the rudder to the fin. Use four hinges in the rudder.
 b. After the glue has cured (about an hour) flex all the hinge lines in each direction a couple dozen times to reduce any stiffness.
59. Swivel the nylon tailwheel bracket into position on the bottom of the fuselage, and mark the two mounting holes. Drill at the marks with a 5/64" drill and screw the bracket to the fuselage with two #4 x 1/2" sheet metal screws.
60. Install the two 3-1/4" main wheels on the aluminum landing gear using the hardware as shown on plan sheet #1. Once the wheels have been attached, the landing gear assembly can be bolted to the fuselage using the three 6-32 x 1/2" mounting bolts.
61. a. If you wish to install a pilot, now is the time to do it. A William's Brothers 2-5/8" Sportsman pilot was used in our prototype models. Be sure to glue it firmly so it won't come loose in flight.
 b. Cut the excess plastic from the canopy using scissors. Cut to the molded line on the sides, and around the front. Cut across on the sharp corner across the back. Sand the rough edges smooth, being careful not scratch the clear plastic.
 c. Trial fit the canopy to the fuselage and trim it as necessary for a good fit. Position the canopy fore and aft so that the raised frame ends at the rear tips of the front top deck and tape it down.
 d. With a soft pencil, draw a line forward on the fuselage along the bottom edge of the canopy, over the front top deck and back along the side. Remove the canopy and carefully cut away a 1/16" wide strip of covering using the line as your guide. The idea is to expose a strip of bare wood where the canopy makes contact so that it can be securely glued to the fuselage.
 e. Check the fit and location of the canopy one more time. If everything is correct wash the canopy with soap and water and dry thoroughly. Now is the time to apply trim tape to the inside of the canopy on the raised area to simulate a frame. Tape the canopy to the fuselage and apply glue along the bottom edge of the canopy.
 f. Dress up the bottom edge of the canopy by applying 1/4" striping tape, half on the canopy and half on the fuselage. Start at the rear corner of one side and work forward up and over the front deck and back along the other side. Another piece of striping tape will finish off the rear edge of the canopy.



BUILDER'S TIP:

CA can be used without fear of fogging the canopy if a light spray of accelerator is applied before taping the canopy down. Use MEDIUM CA as it will not wick as far nor as quickly as THIN CA.

Engine And Fuel Tank Installation

62. a. Engine installation in the FOUR-STAR 60 is simply a matter of bolting the engine and engine mount in place on F-1.
 b. Install the throttle cable on the carburetor arm and assemble the pushrod connector on the throttle servo arm. The exact position of the cable in the pushrod connector will have to be adjusted after the rest of the radio has been installed.
 c. If the construction of the fuselage followed these instructions, installation of the tank is just a matter of sliding the tank through the wing opening and blocking in place. Like most SIG kits, the fuel tank in this model is installed from the rear of the fuel tank compartment rather than through a removable hatch. This choice was made for several reasons: hatch openings make the nose weaker, it's very difficult to keep oil from leaking in around a hatch, a method of fastening the hatch must be built into the fuselage, adding to the complexity and construction time of the model. Further, fuel tanks that are installed properly seldom need to be removed for maintenance.



Radio Installation

63. a. Mount the elevator, rudder and throttle servos in the laser cut plywood tray provided with the kit.
 b. Place the tray in the slot in the doubler. The fore and aft location of the servos will vary depending on engine weight, so it will be necessary to do a preliminary balance with the model to establish the tray position. Reinforce the servo tray/fuselage joint with leftover 1/8"x5/16" balsa stringer scraps.
 c. Cut off the front ends of the outer pushrod tubes about an inch behind the rear of the servo tray.

64. a. Cut two 2-56 x10" threaded rods to an overall length that is equal to the distance from the rudder and elevator servo arms to the end of the black tube. Solder a 2-56 solder clevis to the smooth end of each rod.
- b. Screw the threaded end of the rods completely into the two inner nylon pushrods tubes. Insert the rudder and elevator pushrods into the black outer tube. Connect each clevis to it's respective servo arm.

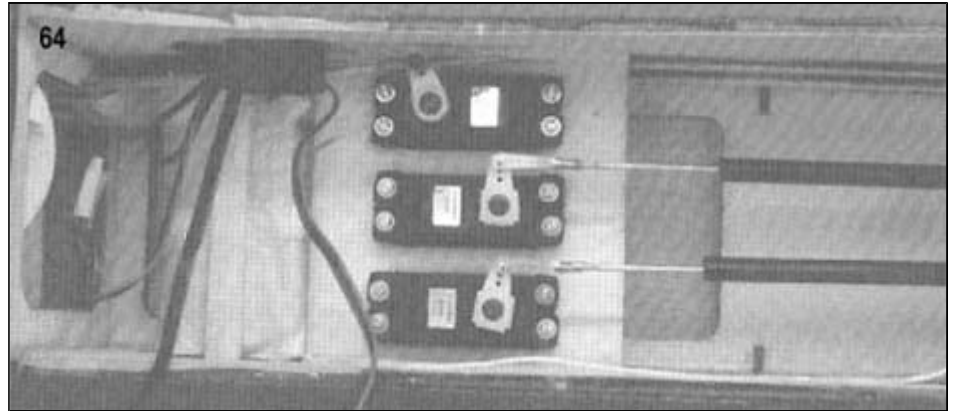

65. a. Screw the nylon control horns onto the rudder and elevator as shown on the plans.
- b. Snap a 2-56 R/C link onto the rudder horn and cut off the rudder pushrod, leaving a 1/8" gap between the end of the tubing and the R/C link. Cut a 2-56 x10" threaded rod to an overall length of 4-5/8", measuring from the threaded end. Install the threaded rod in the nylon tubing, smooth end first, so that approximately 1/2" of the threaded portion remains exposed. The metal rod inside the inner nylon tube will prevent the nylon tubing outside the fuselage from buckling under flight loads. Thread a 2-56 hex nut onto the end of the pushrod, remove the 2-56 R/C link from this rudder horn and thread onto the end of the push rod. Adjust the link until the rudder is in neutral position. Tighten the hex nut against the clevis to reduce the "slop" in the linkage.
66. Snap a 2-56 R/C link onto the elevator horn and cut off the nylon tubing, leaving a 1/8" gap between the end of the tubing and the R/C link. Cut a 2-56 x10" threaded rod to an overall length of 3-5/8", measuring from the threaded end. Install the threaded rod in the nylon tubing, smooth end first, so that approximately 1/2" of the threaded portion remains exposed. The metal rod inside the inner nylon tube will prevent the nylon tubing outside the fuselage from buckling under flight loads. Thread a 2-56 hex nut onto the end of the pushrod, remove the 2-56 R/C link from the elevator horn and thread onto the end of the pushrod. Adjust the link until the elevator is in neutral position. Tighten the hex nut against the clevis to reduce the "slop" in the linkage.

SAFETY TIP: Use a small length of fuel tubing over top of the RIC link. This will keep the link from popping open during flight, causing a loss of control. A drop of THIN CA on both ends of each push rod where the wire enters the tubing will insure that the wires will not pull out of the plastic tubes.

67. a. Hook up the ailerons by installing control horns and aileron pushrods. The servo leads will need short extensions to reach the center "Y" harness required to connect the servos to the receiver. Radio manufacturers generally have these items available as stock equipment. It's best to keep the extensions as short possible because excessively long wires can cause radio "glitches" under certain conditions.
- b. Use the laser cut lite-ply Aileron Positioning Guide (APG) to set the ailerons at neutral (as shown on plan 2 of 2). Adjust the R/C link on each aileron pushrod until the APG seats perfectly against the bottom of the wing and aileron.
68. Always wrap your receiver and battery in foam rubber and position them forward of the servos. If a lighter than average engine is used, it may be necessary to install the battery under the fuel tank to achieve proper balance. Use a scrap balsa stick or rubber bands to keep the receiver and battery pack from moving around during flight.

Pre-Flight Checkout

IMPORTANT! For the first flights make certain that the model balances with an empty fuel tank somewhere between the two points that are shown on fuselage side view. Add weight if needed as trying to fly with the balance point too far aft is much more dangerous than the slight increase in wing loading caused by adding weight to the nose. It is easiest to balance the FOUR-STAR 60 while upside down. By-the-way, a balanced aircraft hangs perfectly level, not nose down, nor nose up. Be certain to range check the radio equipment according to the manufacturer's instructions before attempting the first flight. If there are any questions about range, resolve them now - it doesn't get better when the plane is in the air rapidly disappearing in the distance!!

Another set of problems can be avoided if the engine has been well run in and properly adjusted on a test stand before installation in the airplane.

Before flying, check and adjust all the pushrod linkages so that the control surfaces are in neutral position when the transmitter sticks and trim levers are centered. When you get to the field, don't be surprised if the elevator and rudder are slightly misaligned. Temperature and humidity changes can cause the nylon pushrod tubes to expand or contract slightly. Use the trim levers on the transmitter to return the control surfaces to neutral, and do the final trimming in the air.

The control surface movements listed here are recommended for the first flights of your FOUR-STAR 60. These movements will provide the model with a fair degree of aerobatic capability if it's balanced correctly. Test flights may indicate a need for slightly more or less movement depending on individual model performance and personal preference.

RECOMMENDED CONTROL SURFACE MOVEMENTS	ELEVATOR	3/4" UP and 3/4" DOWN
	RUDDER	1" RIGHT and 1" LEFT
	AILERON	5/8" UP and 5/8" DOWN

The Golden Rule of Success in R/C:

"A model, engine or radio that is not prepared and working properly on the ground before takeoff will not improve in the air - it will get worse! There is no point in attempting to fly until everything is 100% correct."

Flying

The Four-Star 60 is a fun aircraft to fly, but it is not a basic trainer. If you have little or no R/C flying experience, SIG strongly suggests that you get an experienced pilot to help you fly your model until you're comfortable with the controls. Contact a local R/C club or ask your hobby dealer for the names of good fliers in your area and a suitable location for flying.

Make any changes, especially to the balance point, gradually. We recommend that the balance point be shifted no more than 1/8" at a time. In general, moving the balance point forward will make the model more stable, slowing down snap rolls and spins. Moving the balance point back increases sensitivity to rudder and elevator inputs. An aft balance point, carried too far, can produce a model that is completely unstable and uncontrollable. The balance range shown on the plans is a safe area to use for test flights. Don't exceed the rearward CG limit unless you are a very experienced pilot and are totally familiar with the airplane.

LIMIT OF LIABILITY:

The craftsmanship, attention to detail, and actions of the builder/flyer of this model airplane kit will ultimately determine the flight performance and safety of the finished model. SIG MFG. CO.'s only obligation shall be to replace those parts of the kit proven to be defective or missing. The user shall determine the suitability of the product for his or her intended use and shall assume all risk and liability in connection therewith.

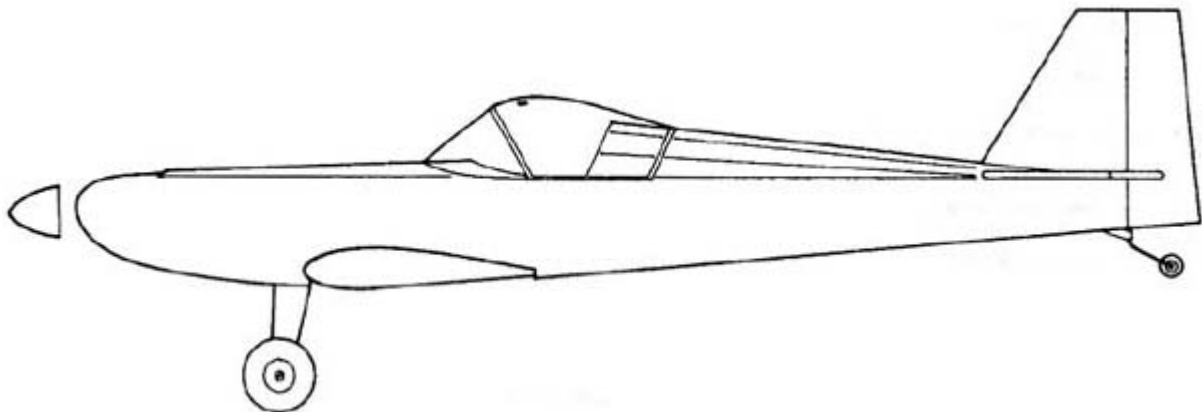

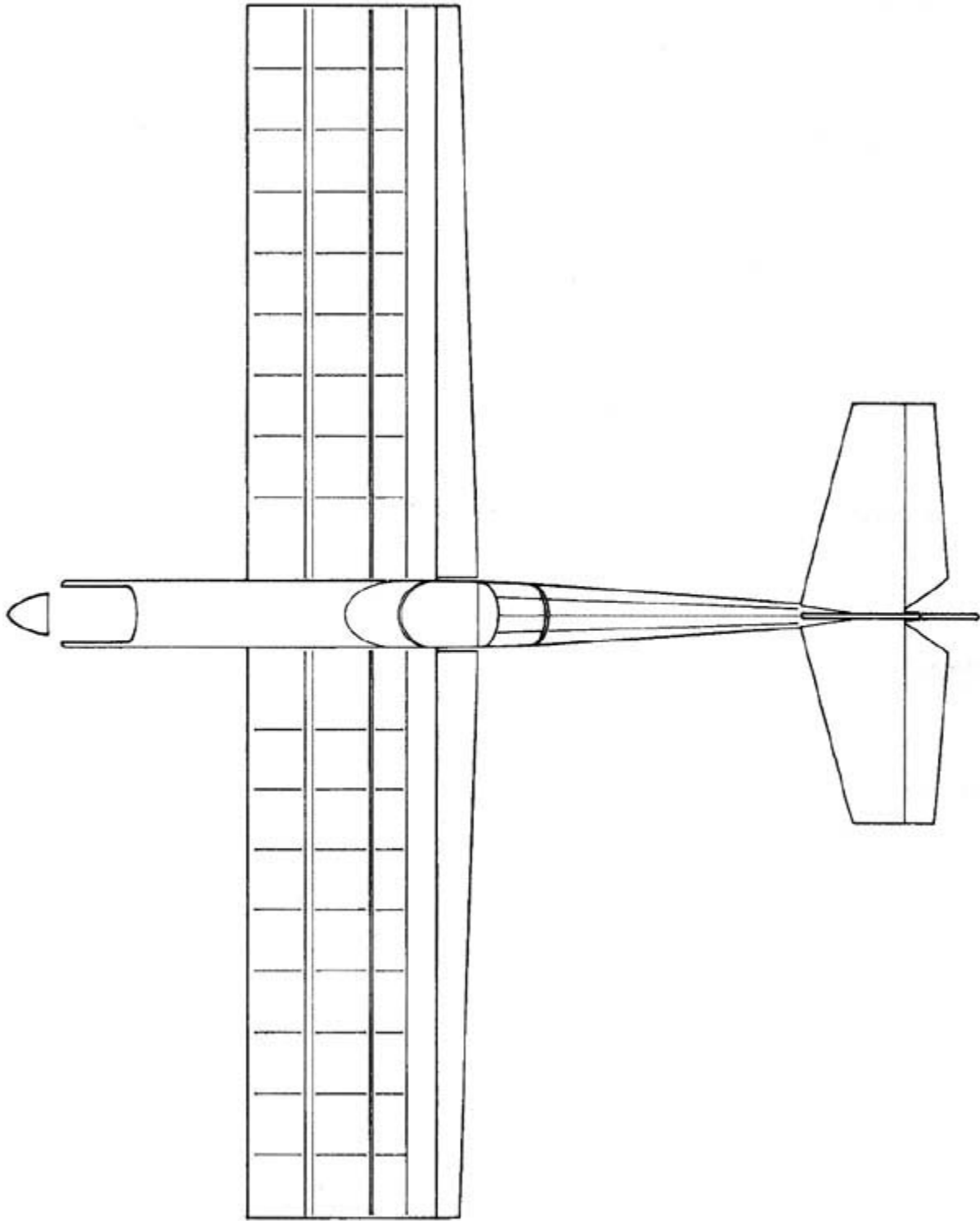

© Copyright SIG Mfg. Co., Inc.

SIG MFG. CO., INC.....Montezuma, Iowa 50171-0520