

Something!
EXTRA

SIG
SIGRC76



INSTRUCTION BOOK



SIG MANUFACTURING CO., INC.

Introduction

The SIG SOMETHIN EXTRA was conceived as an all out fun fly design that does not necessarily look like one. Sure, it has the large, thick symmetrical wings along with generous area and large flight control surfaces, normally associated with fun fly type models but when the whole thing is put together, it's really a great looking airplane! We also wanted this model to be as much fun to build as it was to fly, so we decided early on in the project to produce all of the parts with our laser cutting system, to assure absolute accuracy throughout the building process. The result is that the SOMETHIN EXTRA builds so fast and so accurately, it is almost in a class by itself. The design is totally unique for this type of model in that the wing panels are separate and removable, using an aluminum tube joiner directly through the fuselage. This set-up has a lot of benefits, such as being able to locate the wing panels directly on the thrust line and having virtually the entire fuselage, forward of the trailing edge, available for radio installation and access. Of course, transportation and storage of the finished model also becomes easy and convenient.

The flight characteristics of the SOMETHIN EXTRA are nothing short of incredible. It is fully capable of ultra short field take-offs and landings and almost anything in between. An astounding roll rate, knife edge flight to the next county, instant spin entry and exit, tight inside and outside loops and superb low speed handling are just the beginning! This design has outstanding ground handling characteristics and can be flown in considerable wind conditions. We can't think of a better club contest airplane than the SOMETHIN EXTRA! While this design can certainly be flown with a normal 4-channel radio and five servos, it really gets fun when you use one of today's simple programmable computer radio systems. These radios allow you to mix surfaces, employ flaperons and fine tune and maximize the performance of this model to create an airplane that is nothing short of spectacular in the air. We would also advise you that this is definitely an airplane that benefits from the use of a radio system with dual rates on both the ailerons and elevators. When the model is set-up as suggested in these instructions, you will have an airplane that simply does it all! If you have been looking for a design that is fully up to your flying skills, then the SIG SOMETHIN EXTRA was designed and engineered just for you.

The SOMETHIN EXTRA kit has been very carefully engineered to provide you with an enjoyable building experience. The plans were developed using our powerful CAD (Computer Aided Design) system. To insure absolute accuracy, the individual parts themselves were then generated using these same plans through a path directly to our computerized laser cutting system. This methodology produces incredible accuracy, minimizing and/or eliminating the need to prepare parts prior to assembly. When the above system is used in concert with SIG's legendary quality balsa and plywood, the result is a kit that has only been dreamed of until now.

Your SOMETHIN EXTRA kit is very complete. We have included almost all of the hardware that is required along with a very high quality custom made landing gear and wheel pants to match. However, there are still a few items that you will need to complete this kit. Some of these are:

- 4-Channel Radio System w/ 5 Servos
- Spinner: 2-1/4 Dia.
- 6 Aileron Servo Lead Extension - 2 required
- Wheels: Two 2-3/4 Dia. Mains, One 1 Dia. Tailwheel
- Engine: .40 - .46 2-Stroke or .56 - .65 4-Stroke
- Glue: Thick or Medium and Thin CA and 5-Minute Epoxy
- Paint: Engine Compartment and Wheel pants
- Propeller
- Covering Material: 2 - 3 Rolls (See Covering Section)
- Fuel Tank: 8 Ounce

Engines, Propellers And Mufflers

We have flown our prototypes using two-stroke .40 size engines with excellent results. Our engines were bearing equipped, not the plain bearing type. Plain bearing (or bushed) engines will likely fly the model adequately but will probably not have the top end power for extreme vertical maneuvers. Understand that the SOMETHIN EXTRA was not designed to be a fast airplane but rather a highly aerobatic model. It therefore flies best when equipped with a strong .40 to .46 (even .50 class) engine with bearings. Throttle management through various maneuvers is of course suggested and will result in smoother flight and a lot more fun.

Four-stroke engines will also fly this design. However, by the nature of their construction, they are always heavier for any given displacement. Since it is essential that the airplane balances at the point shown on the plans, using a four-stroke engine may require additional weight and balance considerations to achieve the correct center of balance (or CG).

When using two-stroke engines, avoid heavily pitched props. Ideally, you want your engine pulling as well vertically as it does in horizontal flight. To do this it needs to run at or about its best rpm level to take advantage of its power curve.

Always use an effective muffler! A loud engine could cost you (and possibly your club) the use of your flying site if it offends nearby non-modeling neighbors. Use the muffler that came with your engine or an after-market muffler made especially to quiet two-stroke engines.

Glues

IMPORTANT: The laser cut parts contained in this kit are extremely accurate in outline and fit. They are meant to be used directly out of their sheets, without any trimming or sanding unless specifically called for in the instructions. The laser cutting process produces a brownish edge to the parts and, in some cases, a blackout edge may result when cutting harder plywood parts. CA adhesives work perfectly on these parts and they do not need to be sanded to remove the discolored edges. In fact, sanding the edges of laser cut parts can change their shape and/or dimensions, resulting in a poor fit. **DO NOT** edge sand the laser cut parts in this kit.

Our prototype SOMETHIN EXTRA models were built almost exclusively with SIG Thick CA (cyanoacrylate) glue, SIGCA021 and our Kwik-Shot accelerator, SIGCA030. We use and recommend this glue for several good reasons. The thicker CA formulation provides you with a little more time to properly position the parts. Thick CA does not tend to run and also fills small gaps between parts. Using the Kwik-Shot accelerator along with the thick CA allows you to set the adhesive as required for different types of gluing operations. Some builders may wish to work with the SIG Medium CA glue, SIGCA012, along with the Kwik-Shot accelerator. This glue also works well but with somewhat less working time than the thick variety. SIG Thin CA, SIGCA002, is used to install the Easy Hinges and to adhere reinforcing fiberglass tape in specific locations. We also suggest that you have a bottle of SIG CA Debonder (SIGCA040) available during the construction of this model.

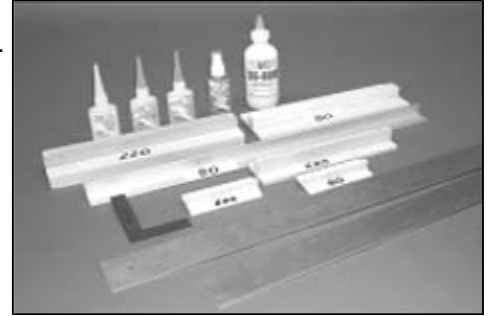

One of the fuselage construction steps will call for the use of aliphatic resin glue, such as our SIG-Bond product SIGSB001. The only epoxy glue that you will need to build this design is SIG Kwik-Set 5-minute Epoxy Glue, SIGKS001.

CAUTION: Some people have experienced allergic reactions when exposed to cyanoacrylate and epoxy glues. This is very rare. However, it is always important to use such glues, as well as paints, thinners, solvents, etc., with adequate ventilation to minimize and/or eliminate fumes.

Sanding Blocks And Straight Edges

It has been correctly said that the difference between a good model and a great one is sandpaper and the knowledge of how to use it. In these instructions you will note that we often mention sanding blocks, T-bar sanders, etc. You will definitely need several sanding blocks to build this model. If you don't already have one, do yourself a favor and purchase a T-Bar sander for this project and your shop. We also suggest that you make some sanding blocks of your own in various sizes. Use 3M 77" Spray Cement to attach the sandpaper to the sanding blocks and T-bar sanders. When the sandpaper gets tired use a heat gun to remove the old sandpaper and attach new. We suggest using 80 grit sandpaper during general construction, switching to 220 or maybe 360 for final sanding, before covering.

In addition to sanding blocks you will need several good straight edges to build this model. One of these should be at least 24" long, preferably 36" .

COMPLETE KIT PARTS LIST

Laser Cut Sheets (See Diagram)

1 Sheet No.1; 1/4"x4"x6" Plywood F-1 Firewall & Landing Gear Mount	1 Sheet No.2; 1/8"x4"x18" Plywood Servo Tray, F-2, Pant Mounts & Forward Hatch Mount	1 Sheet No.3; 1/8"x4"x36" Balsa F-4, F-5, F-6, FB-1, FB-2 & FTR	1 Sheet No.4; 1/8"x6"x36" Lite Ply Tank Floor, F-7, Hatch Base, APG, Fuse Hardpoint Doubler, Canopy Hatch Former, W-1 Rib (2), Canopy Hatch Gauge, F-4 Cap
2 Sheet No.5; 1/8"x4"x48" Balsa Fuselage Side	2 Sheet No.6; 3/32"x4"x24" Balsa Fuselage Doubler	1 Sheet No.7; 1/8"x4"x36" Balsa FB-3 & FSM Stab Mount	1 Sheet No.8; 3/32"x4"x24" Balsa F-4T, F-5T, F-6T, F-3, F-2T, Canopy Hatch Sheet & Top Tank Sheet
1 Sheet No.9; 1/4"x4"x18" Balsa S-2, S-3	1 Sheet No.10; 1/4"x4"x30" Balsa S-1, VF-1, VF-2, VF-3, R-1, R-2, R-3 & R-4	1 Sheet No.11; 1/4"x4"x24" Balsa E-1, E-2, E-3, E-4 & E-5	2 Sheet No.12; 1/4"x4"x24" Balsa A-1, A-2, A-3, A-4 & Fin & Stab Fillers
1 Sheet No.13; 1/8"x4"x24" Plywood W-1A Ribs (2)	1 Sheet No.14; 1/8"x4"x24" Plywood W-2 Ribs (2)	1 Sheet No.15; 3/32"x3"x24" Balsa W-3 Ribs (2)	1 Sheet No.16; 3/32"x3"x24" Balsa W-4 Ribs (2)
1 Sheet No.17; 3/32"x3"x24" Balsa W-5 Ribs (2)	1 Sheet No.18; 3/32"x3"x24" Balsa W-6 Ribs (2)	1 Sheet No.19; 3/32"x3"x24" Balsa W-7 Ribs (2)	1 Sheet No.20; 3/32"x4"x18" Balsa WT Ribs (2)

Sheet Balsa

6 1/16"x4"x24" Wing Leading Edge & Center Section Sheeting	4 1/16"x1-1/2"x24" Wing Trailing Edge Sheeting		
--	--	--	--

Stick Balsa							
7	1/4" Sq. x24" Wing Spars & Turtle Deck Spine	4	1/4" Sq. x11" Wing Spar Doublers	4	1/16"x1/4"x36" Cap Strip Stock	2	1/8"x1/4"x36" Fuselage Stringer Stock
1	1/4"x1/2"x12" Vertical Fin Tailpost	1	3/16" Sq. x24" Hatch Locating Rails	1	3/16"x1/4"x24" Hatch Sides		
Special Cut Balsa							
2	3/8"x3/8"x24" Quarter Round Leading Edge	1	1/2"x12" Triangle Stock - Landing Gear & Firewall Support	2	3/4"x6" Fuselage/Fin Filler Blocks - Diagonal Cut	10	3/32"x4"x1-3/4" Vertical Grain Wing Shear Web Stock
Hardwood							
2	5/16" Dia. x1" Dowel Center Drilled Hardpoint Stock, 1/8" I.D.	1	1/8" Dia. x1" Dowel Rear Hatch Attachment	1	3/16" Dia. x6" Dowel Rear Wing Root Locator		
Wire Parts							
1	1/8" Dia. Steel Wire Pre-Formed Elevator Joiner	1	1/16" Dia. Steel Wire Pre-Formed Tailwheel Wire	10	2-56 x10" Steel Wire Threaded One End Control Rods	1	.065 Dia. x18" Cable Braided Throttle Cable
Molded Parts							
1	Set of Plastic Wheel Pants (2 rights, 2 lefts) SIGSH378	1	Nylon Throttle Cable Tube - 1/8"O.D. x18"	3	Nylon Antenna, Rudder & Elevator Pushrod Tubes - 1/8"O.D. x30"	2	Nylon Rudder & Elevator Pushrod Housing Tubes - 19/64"O.D. x30"
2	Nylon Control Horn - Rudder & Elevator - Medium, Right	1	Nylon Control Horn - Aileron - Small, Right	1	Nylon Control Horn - Aileron - Small, Left	1	4-40 x1" Nylon Bolt - Forward Hatch Hold-Down
1	Set of .40 Motor Mounts - SIGEM001	5	Nylon 2-56 RC Links - Rudder & Elevator (2), Ailerons (2) & Throttle (1)	1	.040 Clear Plastic Canopy		
Hardware							
9	2-56 Solder Links - Tail Supports (4), Ailerons (2), Rudder & Elevator (2), Throttle (1)	4	2-56 Threaded Metal Clevises - Tail Supports	1	2-56 x3/4" Threaded Brass Coupler - Throttle Linkage	4	2-56 x3/8" Round Head Bolt - Tail Support Attach
4	2-56 Hex Nut - Tail Support Attach	1	2-56 Blind Mounting Nut - Tail Support Attach	4	4-40 x3/8" Round Head Bolts - Wheel Pant Attach	5	4-40 Blind Mounting Nuts - Wheel Pant & Forward Hatch Attach
2	J-Hooks, Threaded - Wing Attach	3	6-32 x1/2" Round Head Bolts - Landing Gear Attach	4	6-32 x3/4" Round Head Bolts - Motor Mount Attach	2	6-32 x1-1/2" Round Head Bolt - Wheel Axles
4	6-32 Lock Nuts - Wheel Axle Assembly	2	6-32 Hex Nuts - Wheel Axle Assembly	7	6-32 Blind Mounting Nuts - Landing Gear & Motor Mount Attach	8	#2 x1/2" Pan Head Screws - Control Horn Attach
6	#6 Metal Washers - Wheel Axle Assembly	1	Piece of 1"x8" Fiberglass Tape	18	SIG Easy Hinges - Ailerons (8), Elevators (6), Rudder (4)		
Miscellaneous Parts							
1	7/8 O.D. x15-1/4" Aluminum Tube - Wing Joiner	1	.880 I.D. x16" Phenolic Impregnated Tube - Female Wing Tube Receptacle	1	.092 Formed Aluminum Landing Gear	2	8-1/2 x9-3/4" Plain White Paper - Aileron Servo Lead Tube Material
1	Decal Sheet	1	Set of 38"x50" Plan Set - Sheet 1 of 2 & Sheet 2 of 2	1	Instruction Manual		

About The Building Sequence

The construction sequence provided in this manual has been designed to provide the finished components (wing panels, tail group, etc.) in the order that they will be needed to progress to the following steps. We understand that the quickest and most efficient method of putting a kit together is to usually work on several pieces at the same time. However, we have found that by using CA glue and accelerator and following these instructions, the builder can literally continue building for as long as he or she wants, without having to wait for anything! These instructions assume that the builder is following the sequence provided. It is therefore recommended that you follow the order of construction presented here to avoid later confusion. We suggest that you take the time to read through these instructions, with the plans in front of you, to familiarize yourself with the general layout of the model itself, it's individual parts and the way in which the model is assembled.

Before Beginning Construction

Any references to right or left refer to your right or left, as if you were facing forward in the cockpit.

To build this or any good flying model, you must have a truly flat building board with adequate size for this model. Models that are not built true simply will not perform as intended. Your building board can be a table, an old cored door, a workbench, etc. Whatever you choose for a work surface, it must be flat and true.

Cover the top surface of your building board with a large piece of "Celotex" or even foam insulation board, which will easily accept pins. Be sure to use plenty of pins or weights when building in order to hold assemblies firmly in place.

When building over full-size plans, always protect them with wax paper to prevent glue damage and parts sticking to the plans themselves.

When asked to mark on the parts themselves, do not use a ball point pen directly on the wood. Ink will invariably leach through your film covering material and could ruin the finish. Use a well sharpened #2 pencil for best results. Use a small piece of masking tape and a pen to identify each of the various laser cut parts. To do this, refer to the Key To Laser Cut Parts drawings. Note that the outlines of the actual laser cut parts themselves have been purposely interrupted at various points. This must be done to keep the parts in their appropriate sheets. Use a hobby knife and a sharp #11 blade to remove the parts from their sheets as they are required for each step. All parts included in this kit can be easily identified in the COMPLETE KIT PARTS LIST.

KEY TO LASER-CUT PARTS Use a pencil to identify and mark each part before starting construction.

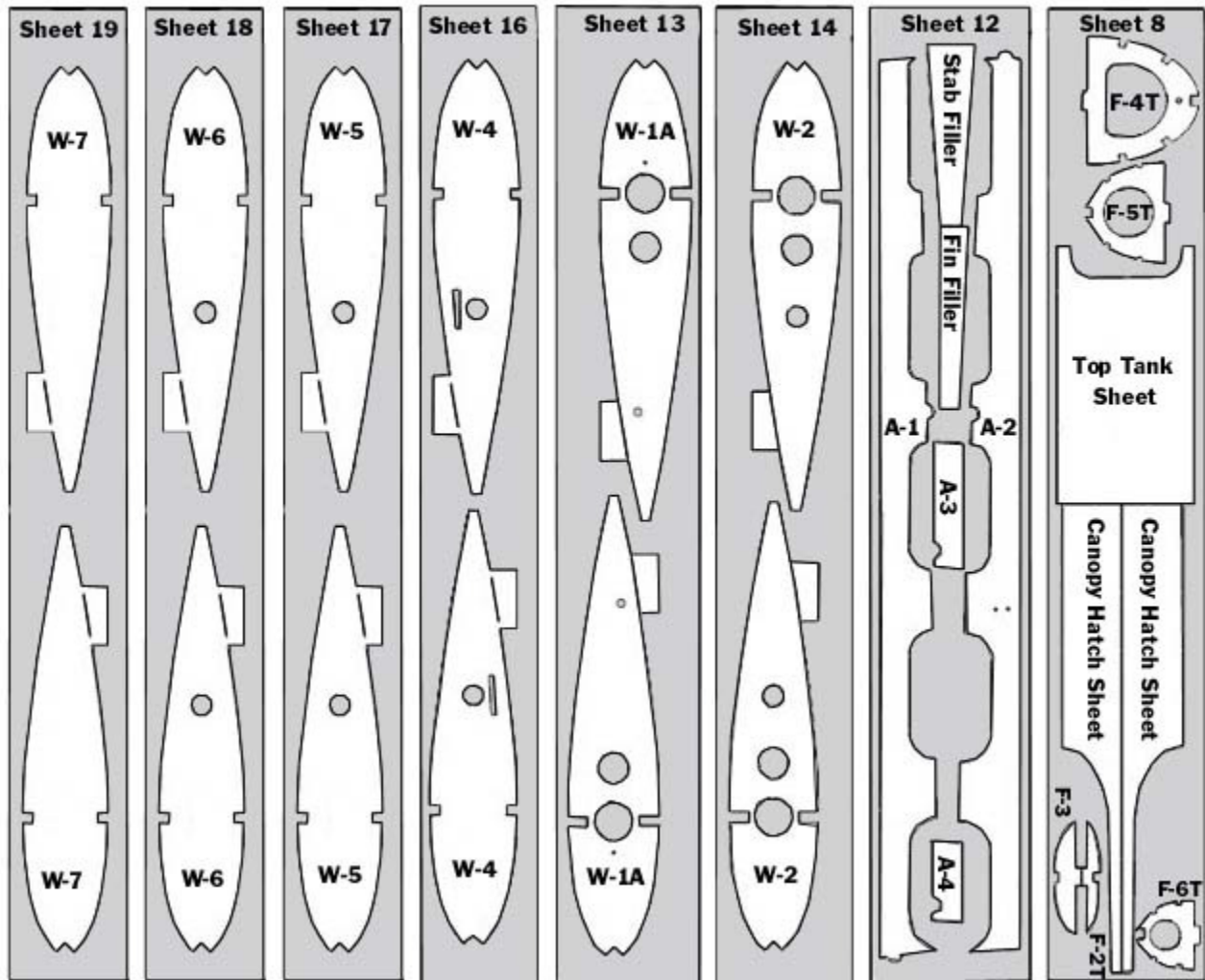

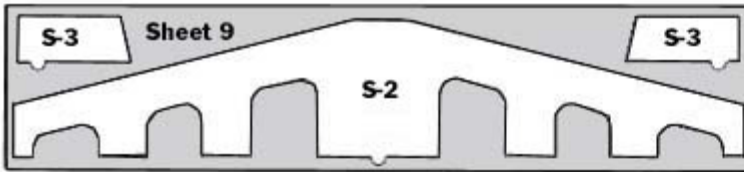

KEY TO LASER-CUT PARTS
 Use a pencil to identify and mark each part before starting construction.

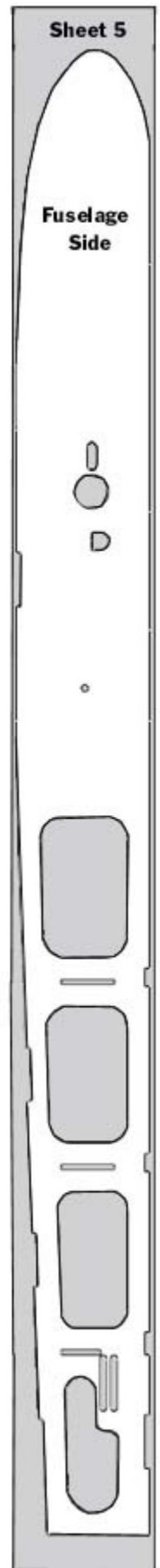
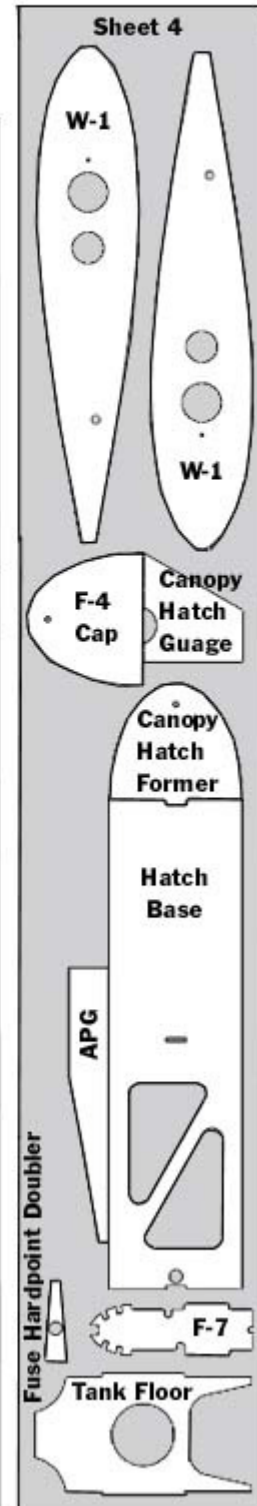
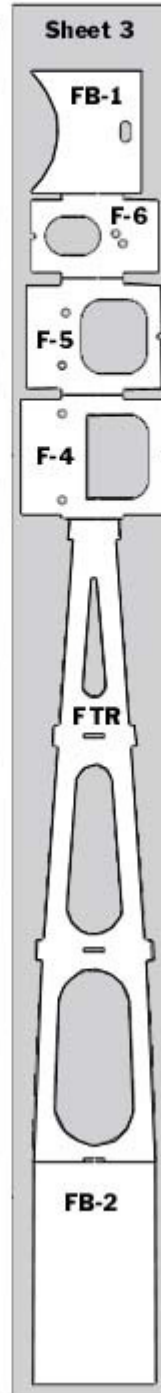
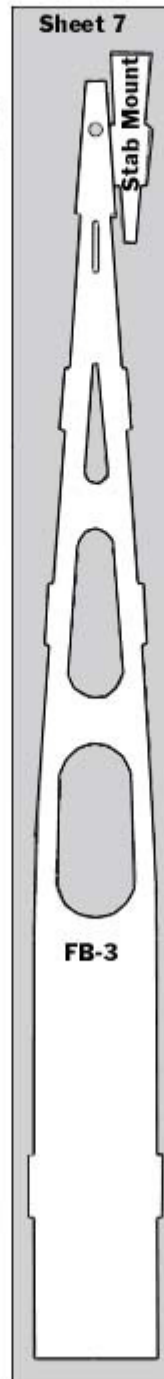
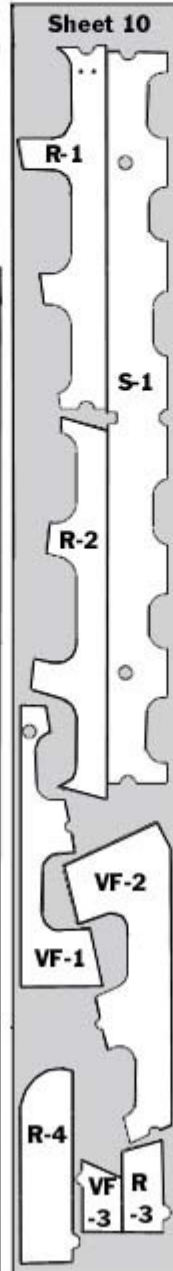
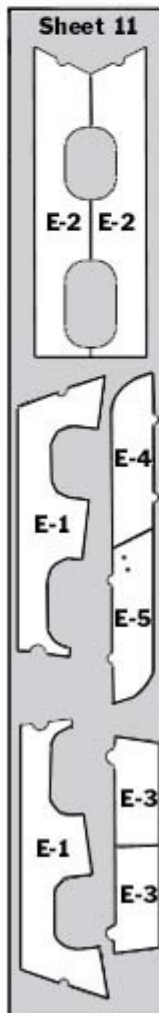
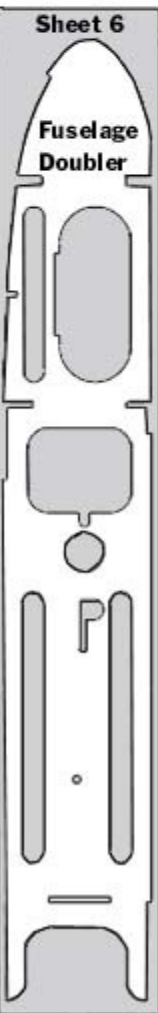
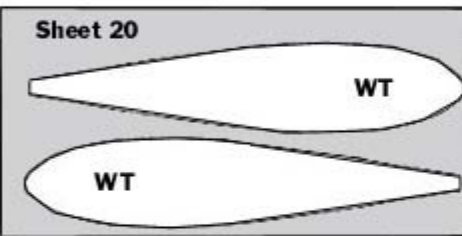
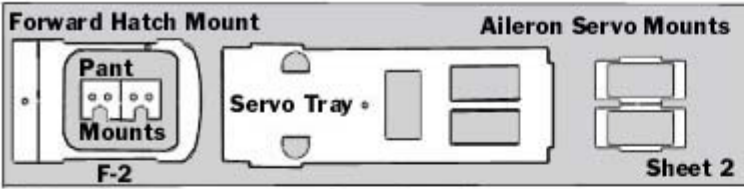

WING CONSTRUCTION

Note: The full size plan depicts both right and left wing panels from the TOP view. These wing panels are initially built directly over the plans and are not removed for the bottom sheeting until Step 12. These instructions assume you are building both wing panels at the same time.

1. In this step, you need to prepare several parts for the construction of both wing panels. Begin by locating four (4) 1/4" sq. x24" balsa sticks and four (4) 1/4" sq. x11" balsa sticks from the kit contents. These will become the top and bottom wing spars. Trim the four 11" sticks to a length of 10-5/8" each. Glue one the 10-5/8" pieces onto one end of one of the 24" spars to create a laminated spar. Repeat this procedure with the remaining three spars. Note that the laminated ends of each spar, now measuring 1/4"x1/2" cross-section, will be the inboard ends.

Next, locate the two (2) ply W-1 root ribs and remove the round fillers in each. Set the two larger, 15/16" dia. fillers from each rib aside, as these will be used to cap the female wing tubes.

Remove the 7/8" dia. x15-1/4" aluminum wing joiner tube from the 16 length of phenolic impregnated female tube. Use a fine-tooth razor saw or power jig-saw to carefully cut two 6 lengths of female tubing, setting aside the remaining 4 piece for later use in the fuselage. Carefully glue one of the 15/16" dia. ply fillers (just removed from the W-1 ribs) onto one end of each of the two 6 female wing tubes. Lightly sand the outer edges of these caps to match the outside diameter (O.D.) of the female wing tubes. Set these tubes aside for use in the following steps.

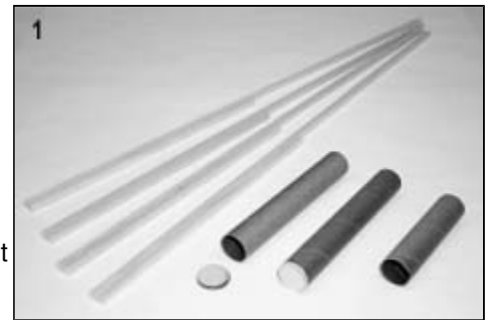

2. Pin the bottom laminated spar carefully in place over the plan, with the laminated end at the inboard location, flush with the outer face of the W-1A rib location. Pin the spar in place from the top to allow the pins to be removed after the top sheeting is in place. The 1/4 sq. laminated length should be sitting on top of the 1/4 sq. full span spar at this point. Use a straight edge to ensure the spar is positioned exactly straight over the plan for the full span of the panel.

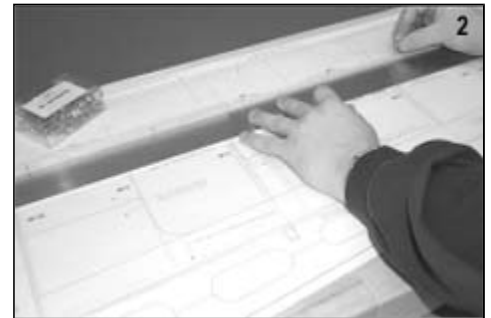

3. From the laser-cut parts in your kit, locate wing ribs W-1A through W-7 and the two plywood aileron servo trays that fit between ribs W-3 and W-4. Check each rib to make sure that each of the laser cut holes are cleared out - vent holes, etc. Now is also a good time to make sure your aileron servos fit into the standard servo cut-outs provided in each of the ply servo trays. If required, trim these trays as needed to allow your servos to fit nicely. This is also a good opportunity to drill the aileron servo mounting screw holes into the trays. We suggest using a power drill for this operation and backing up the trays with scrap ply to avoid splintering. Once this is done, set the trays aside for later installation.

BUILDERS TIP: When pinning ribs to your work surface, pin them in place through each side of the removable alignment/standoff tabs on the bottom rear.

Glue the W-7 tip rib in place onto the spar. Use a 90 deg. triangle to make sure the rib is exactly upright and that it is in place exactly over the plan - pin in place. Glue W-6 and W-5 in place in the same manner - making sure they are exactly upright and over the plan. Pin these ribs in place as well. Glue rib W-4 in place onto the 1/4" sq. spar and against the outer face of the 1/4" sq. spar doubler. Glue W-3 in place. Apply glue to the two tabbed outer edges of the aileron servo tray, spread the W-4 and W-3 ribs a little and fit the servo tray in place into the slots provided in each of these two ribs. Close the ribs to capture the servo tray and pin the ribs in place to your work surface.



4. Glue ply rib W-2 in place, again using a triangle to ensure that it is exactly upright at 90 deg. and exactly over the plan. Ply rib W-1A is now glued in place over the spar.
IMPORTANT: Take your time and be careful installing this rib. To provide the correct relationship to the fuselage, W-1A must be positioned at 90 deg. upright and exactly lined up over the plan.
5. Temporarily install the top spar in place into each rib - do not glue. Lay a piece of balsa wing sheeting over the top spar and ribs and place weights (magazines, metal bars, etc.) on top of the sheeting to make sure the panel is flat to the building surface. Glue the 1/4" sq. x24" balsa trailing edge stock in place to the end of each wing rib. Pin or fixture in place, making sure it is correctly in position and straight. With the wing panel still weighted in place, glue the shaped 3/8"x24" leading edge in place into the notches at the front of each rib, rounded edge facing forward - pin or fixture in place.

6. Remove the weights, wing sheeting and top spar from the wing structure. Slip the previously made female wing tube receptacle in place through W-1A and W-2, leaving 1/8" exposed at the outer face of W-1A - do not glue in place yet. From the contents of your kit, locate the ten (10) pieces of 3/32"x1-3/4"x4" shear web stock. Note that the distance between the rib stations W-7/W-6 and W-6/W-5 are both greater than 4". This requires that you glue two of the 4" shear webs together to create a single 8" length. This 8" length is then trimmed to fit between ribs W-7/W-6. The left over trimmed shear web piece is then glued to another 4" length and trimmed to fit between ribs W-6/W-5. The remaining shear web requirements are each less than 4" and no further grafting is required.

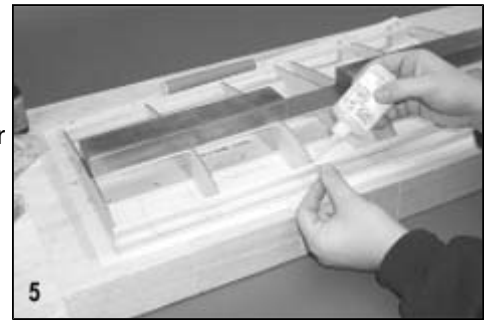

Beginning at the W-7/W-6 location, cut and fit a vertical grain shear web to fit exactly between the top and bottom spars and between each rib. Note that the shear webs are aligned with the front edges of the spars. Once satisfied with the fit, glue the shear web in place to the bottom spar and the ribs, aligned with the top spar location. Move to the W-6/W-5 location and fit and glue the next shear web in place. Repeat this procedure - including the aileron servo bay area between the W-4 and W-3 ribs - up to and in contact with the ply cap on the end of the female wing tube. When all shear webs are in place, remove the female wing tube for later installation.

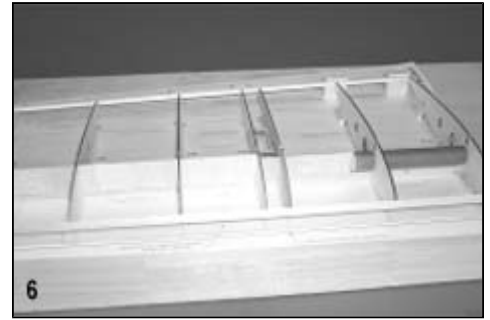

7. Glue the top laminated spar in place into each rib and onto the top edges of the vertical grain shear webs. Use a straight edge and weights to make sure the spar is in place straight and flat.
8. Use a long straightedge to true the edges of a piece of the 1/16"x4"x24" balsa sheet, provided in your kit. With the edges straight, cut and fit the leading edge sheeting in place. Note that the rear edge of this sheet is trimmed to fit halfway across the 1/4" top spar, leaving the rear exposed by 1/8". This exposed spar provides gluing surface for the center sheeting and the cap strips. We have found the easiest way to glue the leading edge sheeting in place is to do it in two steps;
1. Start with the leading edge glue joint, where it mates to the top rear face of the 3/8 leading edge. Apply a bead of glue along the entire length of the sheeting, on its front edge only. Fit the sheeting in place to the top rear face of the 3/8 leading edge stock while holding it up at about a 45 deg. angle. Spray this glue joint with accelerator.
 2. Now apply a bead of glue to each rib, from their leading edges back to the spar location. Then apply another bead of glue along the entire front half edge of the top spar. Uniformly press the sheeting down across the ribs and onto the spar (a long metal straightedge is perfect here). Use a straightedge and weight to hold the sheeting flat to the spar and spray the whole thing with accelerator.

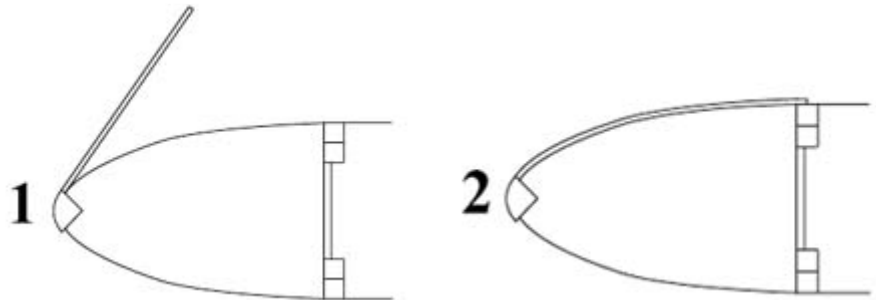
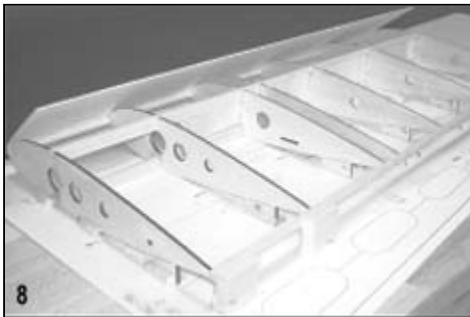

BUILDERS TIP: Whenever applying glue to a long length of wood which must rest on top of another piece of wood - such as wing sheeting on top of a spar - it is important to minimize or eliminate glue oozing from the joint. Keep several pieces of scrap balsa wood handy to scrape along the glue joint, thereby removing most or all of the excess glue.

9. With the wing panel(s) still firmly in place on your building surface, the 1/4" sq. balsa trailing edge now needs to be beveled slightly to conform to the top rear curvature of the ribs. This is most easily handled with a long T-bar sander and 80 grit sandpaper.
10. Locate the 1/16"x1-1/2"x24" trailing edge sheet stock from your kit box. Use a long straightedge to slice both 24 edges perfectly straight. Lay the sheet in place on the wing panel with its rear edge lined up with the rear edge of the 1/4" sq. trailing edge. Hold it in place and mark its forward edge location onto the top of each rib with a pencil. Remove the sheet and apply a bead of glue to each rib from the mark just made back to the trailing edge. Add a bead of glue along the entire top surface of the trailing edge. Carefully position the trailing edge sheet back in place and secure with pins or weights.

11. The two (2) pieces of 1/16"x4"x24" balsa sheet stock provided in your kit are now used to make the center section sheeting for both the top and bottom of both wing panels. Begin by using a straightedge to slice the edges of these sheets exactly straight. Then measure and cut the sheets into four (4) 6" lengths. Now carefully glue two of these 4"x6" sheets together along their 6" edges to create a single 6"x8" piece of sheeting. Repeat this process with the remaining pieces of sheeting. When finished, you should have four (4) pieces of 6 x 8 center section sheeting.

Fit one of the center section sheets in place against the rear edge of the forward wing sheet, with its adjacent edge lined up with the outer face of W-1A. If necessary, use a pencil to mark any trim that may be needed to align this edge with W-1A. Remove the sheet and use a straight edge to trim it. Reposition the sheet in place to check your work. Once satisfied, use a pencil to mark the sheet where it needs to be trimmed to mate to the front edge of the trailing edge sheeting. Do this very carefully to create the best possible fit. Trim the sheet to the marks just made and reposition the sheet in place. The front and rear should be almost seamless and the W-1A edge perfectly aligned.

Remove the center section sheet and use a straightedge and pencil to lightly mark the location of the outboard edge of W-2 onto the back edge of the forward wing sheet and the front edge of the rear wing sheet. Place the center section sheeting back in place and align it carefully. Now transfer the marks just made at W-2 onto the center section sheeting and again remove it. Use a straight edge and pencil to connect the two marks just made. Now use a circle guide or the plans to draw the corner fillets onto the sheeting. Use a straight edge and a sharp #11 blade to now trim the center section sheet to the shape shown on the plans, including the front and rear fillets. Lightly sand as needed to blend everything in and test fit the sheet in place. Once satisfied, glue the sheet in place to the forward and rear wing sheet edges, W-1A, W-2, and the exposed back half of the spar. Carefully position this sheet to minimize high spots, gaps, etc. Use weight or pins to secure in place and spray with accelerator.



BUILDERS TIP: When edge gluing two pieces of sheeting off the structure, it is always best to sand the resulting joint smooth on both sides with a sanding block before gluing the sheet in place. This practice minimizes high and low spots, bumps, etc.



12. Locate two of the four pieces of 1/16"x1/4"x36" balsa cap strip stock provided in your kit. Use this material to now add the rib cap strips to W-6, W-5, W-4, and W-3. These should be carefully centered on each rib and glued in place to avoid high spots, bumps, etc. As shown on the plans, the cap strip over the W-7 tip rib is glued in place with its outer edge flush with the outer face of W-7. Both wing panels can now be removed from your work surface.

13. With the wing panels now free from the work surface, carefully inspect your work thus far. Use a long T-bar sander and 80 grit sandpaper to carefully smooth the entire top surface of each wing panel. Do not use a small sanding block as this can cause dips and flats on the wing surface. The goal is to only smooth any rough areas, not to do the final sanding. Also lightly sand the face of W-1A to smooth any of the top sheeting that may be hanging over its top edge. Turn the panels over and use your hobby knife to carefully remove each of the stand off tabs on each rib. Place the panels back on your building surface with the unsheeted bottom sides up. Insert the female wing tube receptacle through W-1A, W-2 and up against the vertical grain shear web. Apply glue around each tube/rib joint on the inside of the wing only. Also apply glue to the area where the tube s ply cap contacts the shear web.

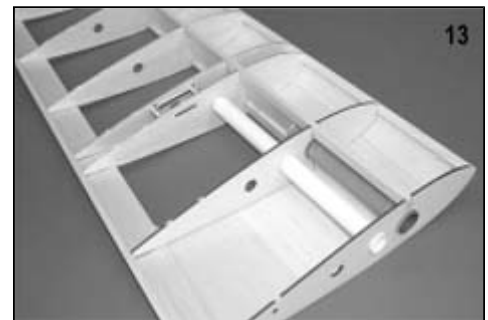

Locate the two (2) pieces of plain white paper, measuring 8-1/2"x9-3/4", from your kit. As shown on the plans, one of these sheets is rolled to form a tube 9-3/4" long. This tube is then inserted into the hole in W-1A, located just behind the female wing receptacle tube. Slip it through W-2 and just into W-3. This paper tube will be the aileron servo lead housing. Properly in place, the inboard end of the paper tube should be 1/8" proud of W-1A, like the female tube joiner receptacle. Apply glue to each tube/rib joint on the inside of the wing only.

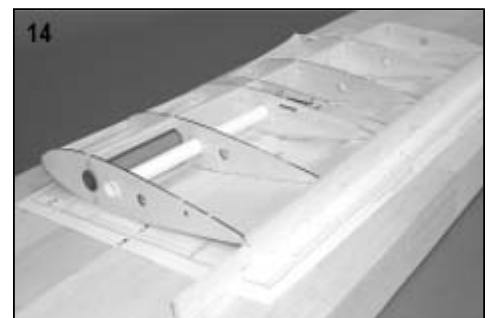

14. **IMPORTANT:** Note that with the bottom sheeting not in place, the wing panels are not yet rigid and may be easily twisted. Once the bottom sheeting is in place, the panels are essentially locked in shape. Therefore, it is very important to properly support the wing panels during this step. We suggest using a length of wood at least 24" long and 1" wide to slip under the trailing edge of the panel, raising the trailing edge about 1" off your work surface. Using this fixture, the wing panel should be laying flat over the top spar location, supported at the trailing edge. Be sure that the 1" wide piece of wood is in full contact with the full span of the wing panel. This will avoid sheeting induced warping. Once the wing is in the correct position, use pins or weights to hold it firmly in place to the work surface and the 1" stand-off.

Using the 1/16"x4"x24" balsa in your kit, the bottom leading edge sheeting is now cut to fit and glued in place exactly as the top leading edge sheeting was in Step 8. Using the 1/16"x1-1/2"x24" balsa in your kit, the trailing edge sheet is now cut to fit and glued in place as it was in Step 10. Last, the center section sheeting, using the two remaining pieces of 1/16"x6"x8" balsa sheet, made earlier in Step 11, are cut to fit and glued in place in each wing panel.

15. Unlike the cap strips over the W-3 and W-4 ribs on the top of the wings, the bottoms must take into account the aileron servo bays and access to them. As shown on the plans, we simply used two (2) 1-5/16" lengths of the 1/16"x1/4"x36" balsa stock provided, to create a forward and rear servo bay opening on the bottoms of these two ribs. Once these two pieces are glued in place, simply cut, fit and glue the remaining cap strip material to cover the W-3 and W-4 rib bottoms, including the spaces between the servo bay cross pieces. The remaining exposed ribs are now covered with cap strips, exactly like the top of the wing panels.



16. Remove the wing panels from your work surface and use a sanding block to smooth the outer surfaces of the W-7 ribs. Glue the WT tip cover rib in place to W-7, aligning its edges carefully to the contours of the wing. Sand the face of W-1A smooth, avoiding contact with the two exposed tube ends. Trial fit the ply W-1 rib in place to W-1A. NOTE: When the W-1 rib is in place, with the female wing receptacle tube inserted into its corresponding hole, the rear 3/16" dia. wing locating dowel holes (in both W-1 and W-1A) will line up exactly. Use the 3/16" dia. dowel in your parts bag as a temporary fixture to maintain this relationship while gluing W-1 in place to W-1A and remove it when W-1 is attached. Glue W-1 in place, making sure it is flat against W-1A and firmly in place. Wipe off any excess glue.
17. As in Step 13, sand the bottom surfaces of the wing panels smooth, using a long T-bar sander and 80 grit sandpaper. Use compressed air and/or a tack rag to remove all dust particles from the wing panels and closely inspect them. Use a good quality, lightweight wood filler - such as "Model Magic" - to fill any nicks, dings or small voids. Finally, use your long T-bar sander and 220 grit sandpaper to lightly sand the wing panels smooth.

18. Locate the two threaded metal J-Hooks from the hardware in your kit. As shown on the plans, one of these hooks is screwed into each wing panel, at the root, just forward of the wing tube joiner location - the W-1 ribs each have a laser cut guide hole for these hooks. When the model is finished, the wing panels will be held in place to the fuselage by a single #64 rubber band, stretched between these two hooks. It is therefore important that the hooks be free of any burrs which might nick or cut the rubber band. Use a "Dremel" Tool and a carbide cut-off wheel to smooth the hook ends of each J-hook, eliminating any burrs. Thread the J-hooks into the W-1 root ribs, leaving about 9/16" exposed, with the open end of the hook facing forward. Leave the hooks in the wing panels for now but do not glue or permanently attach them yet.

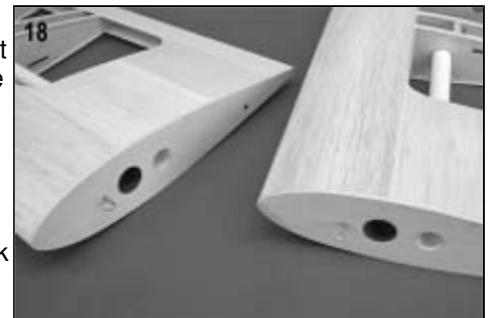

Ailerons

The following instructions assume that both the left and right ailerons are built at the same time.

19. From the laser cut parts in your kit, locate aileron parts A-1, A-2, A-3, and A-4 - two each of all four parts are required. Cover the plans with wax paper and lay aileron leading edge part A-2 in place - pin or weight securely. Glue aileron trailing edge part A-1 in place to A-2. Glue aileron root cap A-3 in place, followed by aileron tip A-4.



20. Remove the completed ailerons from your work surface. Both ailerons should now be sanded smooth. Use a long T-bar sanding tool and 80 grit sandpaper to smooth both sides and the leading and trailing edges of each aileron (80 grit cuts quickly, so don't over do it). Now carefully inspect each aileron for nicks, dings, etc. Use a light filler, such as "Model Magic", to patch any problem areas. Once the filler has set, again use the long T-bar sander, with 220 grit sandpaper, to sand each aileron completely smooth.

21. As shown on the plans, the leading edges of the ailerons are chamfered 45 deg. to allow the extreme aileron and flaperon travel typically used on this design. The quickest and easiest way to do this is to use a pencil to draw a center line on the face of the leading edge of the aileron. Next, mark a point at one end of the aileron, 1/8" behind the leading edge. Make another mark at the other end of the aileron, again at 1/8" behind the leading edge. Use a straightedge and pencil to connect the two marks, giving you a pencil line 1/8" behind the leading edge and parallel with it. Do the same thing to the other side of the aileron. Use a long T-bar sanding tool and 80 grit sandpaper to uniformly sand the corners off the ailerons leading edge at a 45 deg. angle. As you sand, adjust the angle of the T-bar to eventually meet the centerline and the line behind the leading edge. When satisfied, turn the aileron over and repeat the process. When complete you should have a uniformly angled leading edge on each aileron.



22. As shown on the plans, each aileron is hinged to its wing panel with four (4) Easy Hinges. Using the plans, mark the location of each hinge onto both the ailerons and the wing panels. With a hobby knife and a #11 blade, cut each required hinge slot into the ailerons and wing panels. The slots need to be at least 1/2" deep and wide enough to accept the Easy Hinges. Trial fit a hinge into each slot to assure a good fit. Trial fit each aileron in place to its appropriate wing panel. When satisfied, remove the ailerons and set the hinges aside for later use after the wing panels are covered.

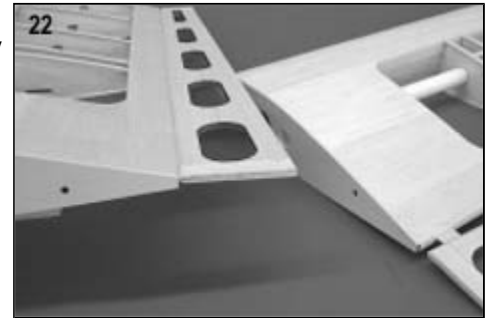

23. From the parts bag in your kit, locate the 1"x8" length of fiberglass tape. As shown on the plans, cut four (4) pieces of fiberglass tape measuring 1/2"x3/4". These will be placed over the laser cut aileron control horn holes, top and bottom, to reinforce these areas. Lay the cut piece of fiberglass in place over the holes and flood the tape with thin CA glue until the weave is full. Allow to set and repeat the process with the other side of the aileron. Repeat the process on the remaining aileron. Use sandpaper to lightly sand the glass smooth.

BUILDERS TIP: After cutting the fiberglass to the right dimensions, hold the piece with a pair of tweezers or hemostats and lightly spray one side with 3M 77" spray cement. The glass will then stay in position on the wood, ready for CA.

Stabilizer, Fin, Elevators And Rudder

24. Beginning with the stabilizer, locate part numbers S-1, S-2, and S-3 (2 each). Pin or weight S-1 securely in place over the plan, carefully lining up its rear edge with the drawing. Apply glue to the rear edge of S-2 and position it in place to S-1 - weight or pin in place and wipe off any excess glue. Glue an S-3 tip to each side of the stab assembly and pin or weight in place.

25. With the stabilizer still in place on your work surface, the elevator halves can now be built. Locate laser cut part numbers E-1, E-2, and E-3 (2 each) and also E-4 and E-5. Protect the stab from glue with a strip of wax paper along its rear edge. Position part E-2 in place against the back edge of the stab, directly over the plan - pin or weight in place. Apply glue to the front edge of E-1 and glue it in place to the back edge of E-2 - weight or pin in place and wipe off any excess glue. Glue elevator tips E-3 in place to the ends of the E-1/E-2 assembly. As shown on the plans, glue E-4 in place to the left elevator half at the inboard edge of the E-1/E-2 assembly. Glue E-5 (with the laser cut elevator horn holes) to the right elevator half, on the inboard side of the right E-1/E-2 assembly.



26. Remove the elevator halves from your work surface. From the parts bag provided in your kit, locate the pre-bent 1/8" dia. wire elevator joiner. As shown on the plans, this joiner fits into each elevator half. Use a pencil to mark the location of the required 1/8" dia. holes that must be drilled into the leading edge of each elevator half to accept the wire joiner. To best control the centering of these holes, we suggest using a non-powered twist drill. Make each hole 1" deep and at 90 deg. to the leading edge of the elevator halves. The leading edges of the elevator halves, from the just drilled holes, inboard through the E-4 and E-5 parts, must now be grooved to accept the 1/8" dia. wire joiner.

This is easy to do using a hobby knife and a #11 blade. A Dremel Tool and a carbide cut-off wheel may also be useful in this step. Once the elevator halves are grooved, trial fit them together with the wire joiner. Adjust the grooves and holes as required to achieve a good fit. Mix a small amount of 5-minute epoxy and apply glue into each hole and channel in both elevator halves. Clean the joiner with acetone and install it in place into each elevator half, wiping off any excess epoxy. Lay this assembly onto your wax paper protected plans, with the leading edges firmly against a straight edge and pin or weight in place. Allow the glue to cure before removing the elevators from your work surface.

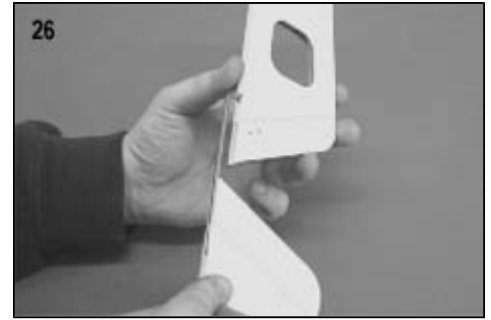

27. The vertical fin and rudder are built in much the same manner as the stab and elevators. From your laser cut parts, locate the VF-1, VF-2, and VF-3 parts for the fin and the R-1, R-2, R-3, and R-4 rudder parts. Also locate the 1/4"x1/2"x12" balsa tailpost, used for the trailing edge of the fin. Cover the plan with wax paper. Cut the 1/4"x1/2" tailpost to the length shown on the plans (save the left over piece for use as a spacer during fuselage construction) and pin it in place, directly over its location on the plan - note that the tailpost extends down through the rear of the fuselage, to the top surface of the ply hardpoint doubler. Glue VF-1 in place to the forward edge of the tailpost.

28. Protect the rear edge of the tail post with wax paper and use weights or pins to hold R-1 in place against it. Glue R-2 in place to the rear edge of R-1. Glue R-3 in place to the top of the R-1/R-2 assembly and glue R-4 in place to the bottom.

29. From your parts bag, locate the two 1 lengths of 5/16" dia. center drilled wood dowels. These will be used to make the hardpoints in the stab (2 each) and the fin (1 each), the rest will be used in the fuselage. Insert one of these dowels into the laser cut hole in the fin so that it bottoms out on the other side. Mark the dowel with a pencil, remove it from the fin and use a razor saw to cut off the piece just marked. Glue the dowel piece into the hole in the fin. Repeat this procedure with the two holes on each side of the stab. Save the excess drilled dowel material as it will be used during fuselage construction.



30. The tail group is now basically assembled. We suggest that now is a good time to sand these assemblies. In order to sand the fin/rudder and stabilizer/elevators assemblies uniformly, use masking tape on one side only to temporarily attach the rudder to the fin and the elevators to the stab and then sand the opposite, untaped sides. Once the sides are smooth, add tape to the now sanded sides, turn the parts over, remove the tape and sand those sides smooth. To begin, use a large sanding block with 80-grit sandpaper. This very quickly smooths these flat surfaces, so don't over do it. Once the surfaces are smooth on both sides and their edges, switch to 220 grit paper to achieve a very smooth surface.

31. Like the ailerons, the leading edges of the rudder and elevators are now be sanded to shape. As shown on the plans, these leading edges are beveled to create a 45 deg. angle, top and bottom from the center line. This angle allows for the extreme surface travel used on this design. Follow the directions in the Aileron section, Step 21, to achieve these required hinging angles.

32. The leading, trailing and tip edges of the fin/rudder and stab/elevators can now be sanded to shape as shown on the plans. Note that we did not overly shape or airfoil these edges but rather simply rounded them. To ensure uniformity, sand these parts with the rudder taped to the fin and the elevators taped to the stab.

33. From the parts bag in your kit, locate the pre-bent tailwheel wire. As shown on the plans, the tailwheel wire is embedded in the forward bottom edge of the rudder. Using the plans as a guide, drill a 1/16" dia. hole in the bottom of the rudder to accept the tailwheel wire arm - about 1/2" deep. Again, we would suggest using a simple twist drill to do this. Once the hole has been made, use your hobby knife and a #11 blade to cut a 1/16" wide channel in front of this hole, allowing the tailwheel wire to nest in place. Trial fit the wire and adjust the channel and hole as required to achieve a good fit. Clean the wire part with acetone. Mix a small amount of 5-minute epoxy and glue the tailwheel wire in place into the bottom of the rudder. Wipe off any excess glue and allow to cure.

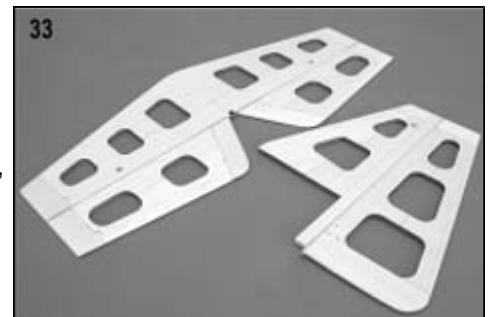

34. Using the fiberglass tape provide in your kit, cut four 1/2"x3/4" pieces. These are glued in place over the rudder and elevator control horn holes with thin CA glue. Next, cut two pieces of fiberglass tape to fold over each of the elevator/joiner wire joints, as shown on the plans, again using thin CA glue. Last, cut a piece of fiberglass tape to fit over the tailwheel wire/rudder location, as shown on the plans. Affix in place with thin CA glue.
35. As shown on the plans, the fin and rudder will be hinged with four (4) hinges and the stab and elevators will be hinged with a total of six (6) hinges - three per side. Using the plans, mark the hinge locations onto each part with a pencil. Use a #11 blade and your hobby knife to cut hinge slots into each hinge location. These must be at least 1/2" deep and wide enough to accept the Easy Hinges provided in your kit. Each time you complete a hinge slot, trial fit a hinge in place to assure a good fit. When all slots are cut, trial fit the fin and rudder together. Do the same with the stab and elevators. Set the hinges aside for use after the parts are covered.

With the exception of notching the fin tailpost for clearance of the elevator joiner - done during fuselage construction - the tail group should now be complete, sanded and ready for assembly during the construction of the fuselage.

FUSELAGE SUBASSEMBLIES

Before starting fuselage construction, there are several subassemblies that should be built and set aside until needed. This is done to avoid interrupting the sequential flow of the fuselage construction. These preliminary subassemblies involve the 1/4" plywood F-1 Firewall, the 1/4" ply Landing Gear Mount and the 1/8" ply Forward Hatch Mount. In addition you will also need the following hardware provided in your kit; seven (7) 6-32 blind mounting nuts, four (4) 6-32 x3/4" round head slotted bolts, one (1) 4-40 blind mounting nut and two (2) glass-filled engine mounts. You will also need the engine you plan to use available to you for the following steps:

36.
 - a. Use the laser cut vertical and horizontal centerline reference marks at the edges of the F-1 firewall to draw a vertical centerline and horizontal thrust line onto the fire wall.
 - b. Determine the required spacing between the two engine mounts to fit your particular engine. Use a pencil to mark that spacing onto the face of the firewall. (Example: If the width of your engine s case is 1-3/8", then divide that figure in half (11/16") and mark the face of the firewall with the 11/16" measurement on each side of the vertical centerline. Use a triangle to draw two parallel lines, one at each 11/16" point, thus giving you the centered location for each motor mount arm.
 - c. To temporarily hold it in place, apply a drop or two of CA glue to the back of one of the motor mounts and place it onto the firewall, lining up its inside edge to the line drawn in b. above and the laser cut top and bottom bolt holes. Insert the bolts into the holes in the front of the mount arm and through the firewall. Thread the blind nuts partially onto the ends of the bolts at the back of the firewall. Carefully apply thick CA to the outer surface of the blind nuts and use a screwdriver to tighten the bolts, thus drawing the nuts firmly into the back surface of the firewall. Repeat this process for the remaining motor mount arm.
37. Place your engine onto the two motor mount arms, still bolted to the firewall. Hold this assembly over the plans to determine the mounting position of your engine, allowing the prop/spinner to clear the fuselage sides at the nose. Mark this position on the motor mount arms. Holding your engine in place on the mounts, use a pencil to mark the locations of the four required engine mounting holes onto the mount arms. Remove your engine. Use a power drill with a 9/64" dia. drill bit to now drill the four bolt holes through the motor mounts at 90 deg. Your engine can now be mounted in place when the time comes. Remove the bolts and motor mounts from the firewall.
38. Apply thick CA glue to the outer surface of one of the 6-32 blind mounting nuts and position it in place into one of the holes in the 1/4" ply landing gear mount. Use a hammer to lightly tap the blind nut in place into the wood. Repeat this step for the remaining two blind nuts. Set the mount aside for later assembly.
39. Apply thick CA glue to the outer surface of the 4-40 blind mounting nut and position it in place into the hole in the center of the 1/8" ply forward hatch mount. Use a hammer to lightly tap the nut into the wood. Set the mount aside for later assembly. This completes the fuselage subassemblies.

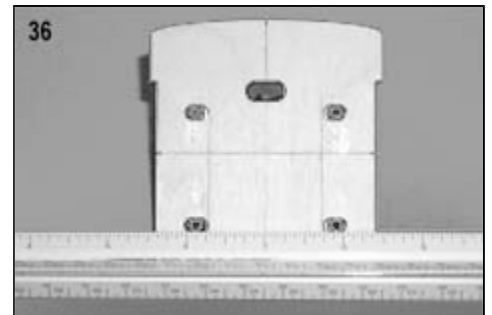
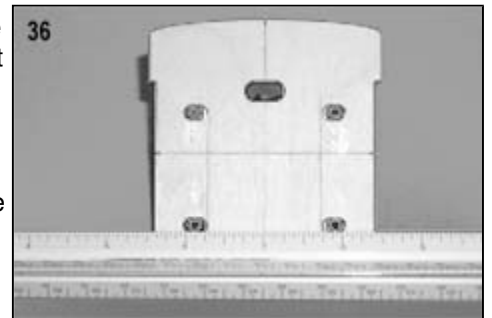

FUSELAGE CONSTRUCTION

40. The fuselage doublers are now glued to the fuselage sides to create a LEFT side and a RIGHT side. This step is important because several components must be carefully aligned. Therefore, we suggest that you use a slower setting glue, such as an aliphatic resin like the SIG-Bond product. Using this glue gives plenty of time to position parts correctly. Start by fitting these parts together to see how they relate to each other - again make sure you are working with a LEFT and RIGHT fuselage side and doubler. Note that both the doublers and the fuselage sides have holes in them to accommodate the female wing tube - this is the forward positioning locator for the doubler. The rear locator is the 3/16" dia. hole in both parts which accepts the 3/16" dia. rear wing locator dowel. The easiest and most accurate way to position and glue the fuselage doublers in place is to use one end of the remaining 4" length of female receptacle tube to position the doubler to its fuselage side. Then use one end of the 3/16" dia. dowel to position the rear of the doubler to the fuselage side. Once the doubler is in place against the fuselage side, pin or weight it in place, remove the tube and dowel and allow the assemblies to dry.

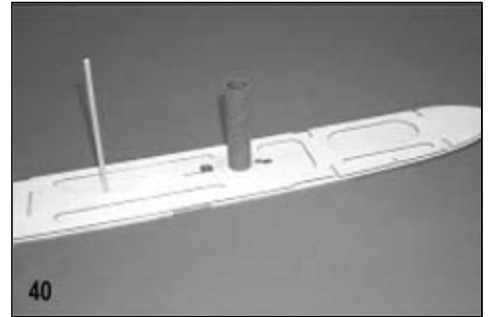

41. Start with either the right or left fuselage side and glue firewall F-1 in place, using a 90 deg. triangle to position it exactly upright to the fuselage side. Use the same technique to glue formers F-2 and F-4 in place.

NOTE: Former F-2 has a laser cut hole on one of its sides to accept the throttle cable housing tube. F-2 can be installed with this hole on either the right or left side, depending upon which side the carburetor throttle lever is located on your engine. Check this first before installing F-2.

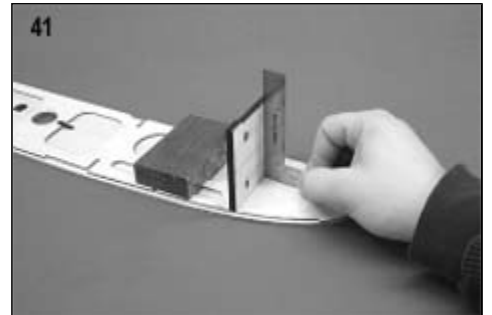

42. Before gluing the 1/8" ply servo tray in place, take a moment to make sure your servos fit into the laser cut openings provided. With the servo tray not yet installed, it is easy to adjust these openings as required and to drill the required holes for mounting them to the tray. Once the tray is ready, glue it in place to the fuselage side - just above the 3/16" dia. rear wing locator dowel hole and to F-4, engaging the rear tab on the servo tray in the top cut-out in F-4.

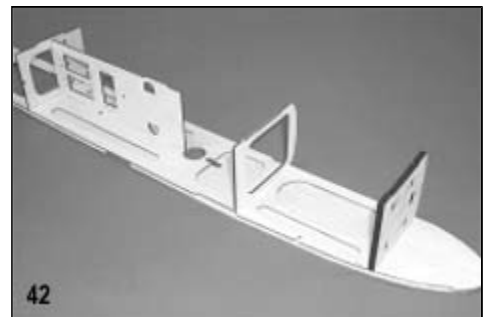

IMPORTANT: With both fuselage sides properly in place, the rear 3/16" dia. holes for the wing root locating dowel, on each side of the fuselage, must be clear. Later, when this dowel is installed, it must pass through these two holes and fit directly beneath the servo tray, as shown on the plans. If you see any interference from the servo tray, DO NOT adjust the holes, adjust the servo tray if required.

43. With the exception of the 1/8" tank floor, all parts are now in place to accept the opposite fuselage side. Trial fit the fuselage side in place, engaging F-1, F-2, the servo tray and F-4 in their respective slots. The fuselage side should fit perfectly without any need for trimming. Remove the fuselage side, apply glue to the mating edges of the above parts and fit the fuselage side back in place, using weights or pins to hold it perfectly flat. Apply accelerator to the glue joints.

44. Glue the 1/8" ply forward hatch mount in place, between the fuselage sides and against the upper rear face of F-2 (the 4-40 blind nut should be underneath the hatch mount, as shown on the plans). On the bottom of the fuselage, glue the 1/4" ply landing gear mount in place, between the fuselage sides and against the rear bottom edge of F-2, with the 6-32 blind nuts on the inside of the fuselage as shown.

45. Use the 12" length of 1/2" balsa triangle stock provided in your kit to cut two (2) 3-1/4" lengths to fit directly behind the firewall, at each corner where it meets the fuselage sides. Position each piece and press them firmly against the blind nuts to leave an impression. Use a hobby knife to cut shallow half-round reliefs in each piece to clear the nuts. Glue these in place, keeping glue away from the nuts. Use the remaining triangle stock to cut, fit and glue a piece to fit on the top front edge of the landing gear mount, against the bottom rear of F-2, as shown on the plans.



46. Glue the 1/8" ply tank floor in place to the fuselage sides, the back face of F-1 and the front face of F-2. Using the 1/8"x1/4"x36" balsa stock in your kit, cut a 3" length. This piece is now glued into the slots in the doublers, on the bottom of the fuselage, beneath the tank tray.
47. Insert the remaining 4" length of female receptacle tube into one fuselage side and out the opposite side. Mark the excess tubing with a pencil and remove the tube. Cut the excess material off with a razor saw and reinstall the trimmed tube back in place. Its edges should be flush with the fuselage sides. Holding the tube in place, use a sanding block to lightly sand its outer edges smooth with the fuselage side - do not glue in place yet.
48. From your kit, locate the .875"x15-1/4" aluminum tube wing joiner and the 3/16" dia. x6" wood dowel. Use sandpaper to smooth each end of the tube, chamfering the ends a little to help it fit into the female receptacle tubes a bit easier. Insert one end of the aluminum tube into the fuselage receptacle tube, sliding it all the way through and roughly centered on the fuselage. Insert the 3/16" dia. dowel into the rear 3/16" dia. hole (located just beneath the servo tray) and center it in the fuselage. Slide a wing panel in place by inserting one end of the aluminum tube into its receptacle, sliding it to the fuselage. The rear dowel inserts into the mating hole in W-1. Press the panel in place to the fuselage.



Repeat the procedure to mount the remaining wing panel. Hook a #64 rubber band to one of the J-hooks and stretch the rubber band three times between each hook to seat the wing panels in place. Check the relationship of the wing panel root ribs to the fuselage sides - they should be flush with no gaps. With the wings still attached, apply glue to the inside female wing tube/fuselage side joints. Also apply glue to the female wing tube, where it meets the front edge of the servo tray.

49. **IMPORTANT:** In this step you will install the rear fuselage formers. Because of the rudder and elevator pushrod orientation, they must be installed in the correct direction. The cross sections on the plans show these formers facing forward, toward the nose - this is the correct position for each former. Locate the 1/4"x1/2" leftover length of balsa that you were asked to save in Step 27. This piece of scrap will now be used as a spacer at the rear of the fuselage. Hold the two rear fuselage sides together with the 1/4"x1/2" spacer between them (the 1/4" width simulates the tailpost on the fin) and tape or pin the assembly accurately and securely in place. Glue rear 1/8" ply former F-7 in place. Glue former F-6 in place, followed by F-5.

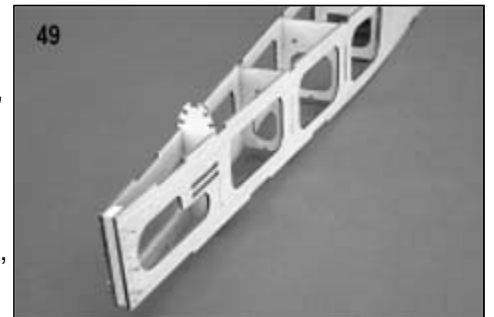

50. From the contents of your kit, locate one (1) 1/8" O.D. x30" length of inner nylon tube. This tube will be used for the internal receiver antenna housing/exit. Use a piece of 220 grit sandpaper to scuff up the outer surface of this tube. As shown on the plans, insert one end into the 1/8" hole in the bottom of the servo tray, just ahead of the throttle servo location, leaving about 1/16" exposed on the top of the tray. Glue the tubing in place to the tray. Now bend the tubing back toward the rear of the fuselage and press it into the bottom center slot in former F-4 and glue it in place. Press the tubing in place into formers F-5, F-6, and F-7. Glue the tube in place to F-5 and F-6 but not to F-7 yet. Do not yet trim the excess tubing.



51. Locate the long fuselage bottom sheet part FB-3 and the shorter 1/8" ply hardpoint doubler from your kit contents. As shown on the plans, the hardpoint doubler is glued in place on top of the FB-3 part, at the very rear, with the 5/16" dia. holes in each part aligned. Glue these parts together now. Cut a 1/4" length off the remaining length of 5/16" dia. center drilled dowel. From your hardware package, locate one (1) 2-56 blind mounting nut. Apply glue to the outer surface of the nut and insert it into one end of the dowel. Press the nut in place firmly and wipe any excess glue. Glue the dowel/blind nut part into the 5/16" dia. hole at the rear of FB-3, with the nut located inside the fuselage. Lightly sand the dowel smooth with the surface of FB-3.



52. Remove the 1/4"x1/2" spacer from the rear of the fuselage. The Fuselage Bottom part FB-3 is now glued in place. First feed the nylon antenna tube through the slot in the rear of the part. Fit FB-3 in place, securing it firmly to the fuselage sides with tape. Use thin CA glue with an applicator extension to glue FB-3 in place, from the inside of the fuselage. Also apply glue to the bottom edges of the F-4 through F-7 formers, where they contact FB-3.

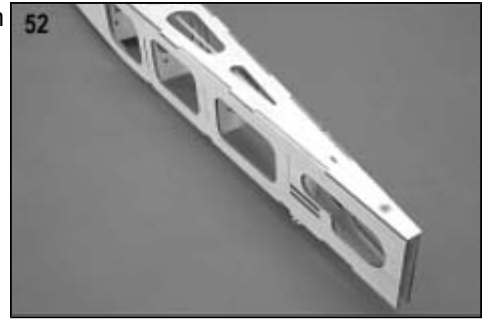

53. Turn the fuselage upright and from the inside, apply glue to the antenna tube exit. Turn the fuselage over and use a sharp single edge razor blade to trim the excess antenna tube flush with the bottom surface of FB-3. Use a sanding block to sand this antenna exit location smooth. We would suggest using a little light weight filler to fill this area.

54. The outer elevator and rudder pushrod tubes are now installed. As shown on the plans, these nylon tubes fit through all the formers, from F-4 back through F-7, through the holes provided in each former. Also note that these two pushrod tubes cross each other between F-6 and F-7. As a result, the elevator pushrod, driven by the elevator servo mounted on the left side of the tray, exits the right side of the fuselage, through the upper exit slot. Likewise, the rudder servo is mounted on the right side of the servo tray, with the rudder pushrod exiting the left side of the fuselage through the lower exit slot.

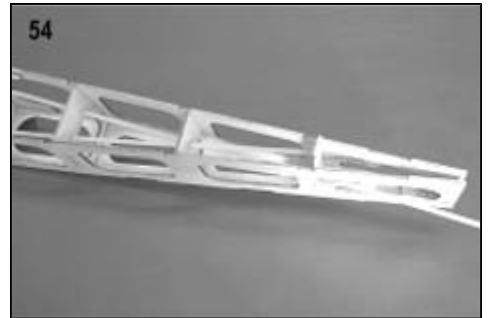

Also note that only about 3/32" of tubing protrudes through the front of F-4. Use 220 grit sandpaper to scuff the outer surface of the pushrod housing tubes. Feed each tube through the appropriate holes in the formers and out the correct upper and lower exit slots at the rear of the fuselage. Glue the tubes in place to each former and exit slot. Trim the excess tubing flush with the fuselage sides at the exit slots with a single edge razor blade. Lightly sand the exits smooth with a sanding block. Use light weight filler to fill any voids at the exit slots.

55. Glue the Fuselage Top Rear sheet (FTR) in place from the top rear face of F-4 to the front face of F-7. This is easy to do by first fitting FTR securely in place to the fuselage and using thin CA glue with a thin applicator extension, applying the glue from the inside of the fuselage. Glue the Fuselage Stab Mount (FSM) in place behind F-7, into the fuselage sides. Lightly sand the top surfaces of these parts smooth with a small sanding block.

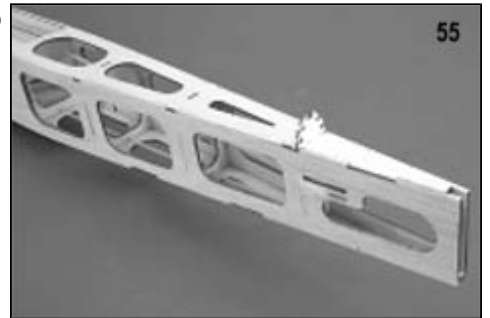

56. Glue Fuselage Bottom part FB-2 in place beneath the tank compartment and then glue the forward Fuselage Bottom part FB-1 in place. Use your sanding block to lightly sand the bottom of the fuselage smooth.

57. The engine throttle cable tube should now be installed. Locate the 1/8" O.D. x18" length of nylon tube from your kit contents. As shown on the plans, drill a 1/8" dia. hole through the F-1 firewall, lined up with your engine's throttle arm. The 1/8" nylon tube passes through the firewall and through the laser cut hole in F-2, where it terminates at the throttle servo location, lined up at the same level as the servo output arm. Later, you will install the throttle cable into this tubing. Before slipping the tube in place, scuff the surface with 220 grit sandpaper, install it and glue in place with thick CA. Trim the excess tubing in front of F-1.

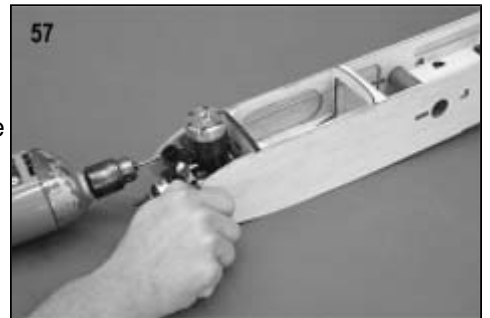

58. Before closing the tank compartment with the top tank sheet, we suggest that you first make some preparations for installing your fuel tank:

- a. The fuel tank shown on the plans and used in our prototypes is a standard 8 ounce Du-Bro tank. This tank is installed through the top canopy hatch opening, through F-2 and onto the tank floor. The laser cut oblong hole in the F-1 firewall is there to allow two fuel lines to pass through (one line to the carburetor and the other to the pressure nipple on the muffler). This is a simple 2-line system allowing the model to be fueled through the carburetor line with the overflow on the pressure line. Some builders may be tempted to create a removable tank hatch directly over the tank for easy access. In the interest of lightness and structural integrity, we suggest that you do not do this. Realistically, the tank only needs to be inserted once so constant access is not a real issue.



Access to the tank is easy if you use filament strapping tape to create a rear tab that allows you to grasp it and pull the tank out if needed. To do this, use alcohol to first clean the outside of the tank. Then wrap the length of the tank one or two times with strapping tape. Then wrap a third time, folding a 1-1/2" - 2" tab at the rear. The tab gives you a nice grip on the tank in order to easily pull it out.

- b. The tank compartment in this design is large, leaving space between the fuselage sides and the tank when it is in place. Since the tank must be held firmly in place, you need to address this requirement now, while you have access to the compartment. We use a very easy and virtually weightless method to accomplish this task. We first cut two (2) 2"x5" pieces of 1/2" thick open cell foam rubber (the light kind, used for furniture padding, packing material, etc.). We sprayed one side of each of these foam rectangles with 3M 77" Spray Cement and adhered them to each fuselage side, inside the tank compartment. When the fuel tank is installed, simply push the tank into the compartment and it will be firmly held in place between these two foam pads.



59. With the fuel tank and throttle tube considerations addressed, the laser cut top tank sheet can now be glued in place. This sheet ends at the rear face of F-2 and extends forward over F-1 onto the fuselage sides. Trial fit this sheet in place. Sand its edges to bevel them, allowing them to fit to the fuselage sides, without gaps. Once you are satisfied with the fit, glue the sheet in place, using masking tape to hold it firmly. When the glue has set, sand the rear edge of the sheet smooth with the face of F-2 with a small sanding block.
60. Locate the 1/8" ply hatch base and the 3/16" sq. x24" balsa hatch rail stock from your kit contents. As shown, the hatch base has two 3/16" sq. locating rails glued to its bottom side, locating it to each fuselage side. Start by cutting two (2) 11-3/16" lengths of 3/16" sq. balsa stock. To position these accurately, fit one piece into the fuselage just behind the forward hatch mount and in front of F-4. Use a scrap piece of 1/16" balsa to space the rail 1/16" above the fuselage side and secure it with pins, from the outside of the fuselage.

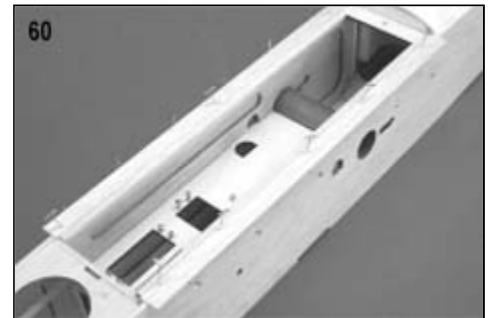

Take your time and make sure it is uniformly spaced 1/16" above the side of the fuselage. Repeat this process on the opposite side with the remaining rail. Glue the ply hatch base onto the tops of each rail, aligning its edges with the fuselage sides and holding its forward end (with the 5/16" dia. hole in the center) against the back face of F-2. Use accelerator to set the glue. Remove the pins holding the rails in place and remove the hatch base.

61. Using the lite ply canopy angle guide, glue F-4T in place onto the front edge of FTR (note that the tab on F-4T fits into the slot in the forward edge of FTR). Use a 90 deg. square to glue top formers F-5T and F-6T in place into their respective slots in FTR.
62. Trial fit the top 1/4" sq. balsa spine in place into F-4T, F-5T, F-6T and F-7. Carefully trim the ends to match the front face of F-4T and the rear face of F-7. Glue the spine in place. Using the 1/8"x1/4"x36" balsa stock provided, cut, fit and glue the four (4) remaining side stringers in place into the same formers. Sand the face of F-4T and F-7 smooth with a small sanding block.



63. From the parts bag in your kit, locate the 1/8" dia. x1" dowel. Also locate lite ply formers F-4 Cap (without bottom tab) and the matching Canopy Hatch former (with tab). Cut the dowel to a length of 1/2", round one end with sandpaper and set it aside for the moment. Insert the remaining 1/2" length into the hole in F-4 Cap former, to act as a positioning guide. Apply glue to the front face of the F-4T stringer former and glue the F-4 Cap former in place, using the dowel as a locator. Remove the dowel.

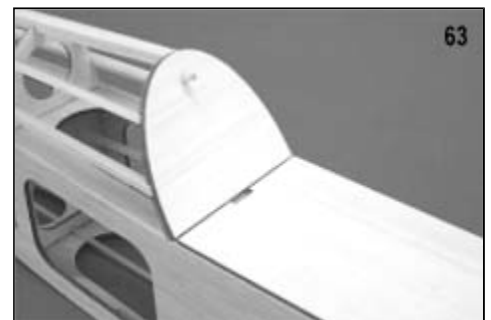

64. Install the hatch base onto the top of the fuselage with a strip of wax paper at its rear edge, protecting the F-4 Cap former from getting glue on it when the Canopy Hatch former is in place. Secure the hatch base to the fuselage with masking tape. Apply glue to the bottom edge of the former and glue it in place to the back edge of the hatch base, engaging its tab into the slot. The former should be in full contact against the face of the F-4 Cap. Insert the scrap 1/8 dia. dowel through the hole in the Canopy Hatch former, F-4 Cap former and F-4T, aligning all three with each other. Use accelerator to set the glue and remove the dowel.

65. Remove the tape and remove the canopy hatch assembly from the fuselage. Apply glue to the unrounded end of the 1/8" dia. dowel prepared earlier and insert it into the back face of the Canopy Hatch former, flush with the front face. Set the glue and sand the front of the former smooth with a small sanding block.

BUILDERS TIP: Before gluing the top hatch sheet in place you may consider adding a little color to the exposed wood hatch floor and rear canopy hatch former, to show through the canopy. The model on the kit box has a zinc chromate color. We did this using light weight colored art paper. This is available in many different colors - gray, flat black, etc. We cut a piece to shape and used 3M 77" Spray Cement. It is an effective look and adds no weight.

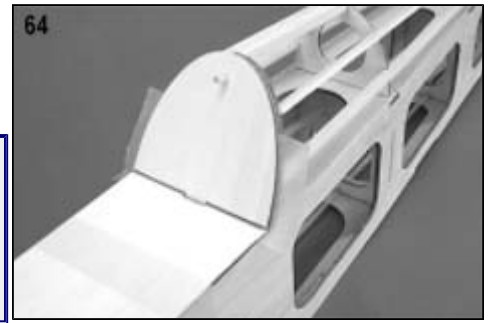

66. Re-install the canopy hatch assembly onto the fuselage with a small strip of wax paper underneath the front edge, folded up to protect the back face of F-2 from glue. Locate and glue in place formers F-2T (located at the front of the hatch base, against F-2) and F-3. Cut and fit the 1/8"x1/4" balsa top stringer in place between these two formers. Cut two (2) 11-3/4" lengths of 3/16"x1/4"x24" balsa, provided in your kit and glue them in place to the left and right sides of the hatch base, on the 3/16" edge. These strips extend from the front edge of the hatch base back to the angled canopy hatch former, aligned with the fuselage sides. Remove the canopy hatch and lightly sand the faces of F-2T and F-3 smooth. Use a larger sanding block to lightly sand the top of the stringer smooth to the contours of F-2T and F-3.

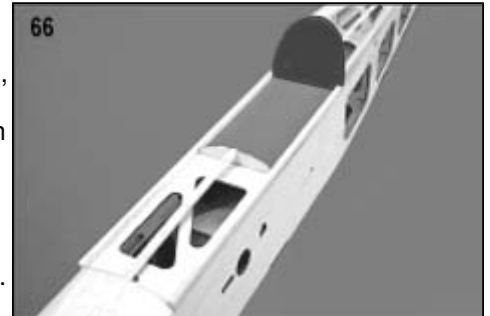

67. The two laser cut 3/32" balsa canopy hatch sheets are now glued in place. Use a sanding block to chamfer the outer edge of one of these sheets to fit against the 3/16"x1/4" outer hatch edges. Apply glue to the chamfered outer edge and glue in place against the outer hatch edge. Apply glue to the tops of F-2T, F-3 and half of the hatch stringer. Glue the sheet half down to the formers and stringer. Repeat this process on the opposite side of the hatch. It may be necessary to slightly trim the center joint line to achieve a smooth fit. Trial fit the canopy hatch in place onto the fuselage. This is done by first engaging the rear dowel into the locating hole in the F-4 Cap, centering the locating rails and pressing the hatch in place. There should be very little gap at the front of the hatch. If the fit seems too tight, lightly sand the face of F-2T.

68. Locate the remaining length of 5/16" dia. center drilled dowel. As shown on the plans, this dowel fits into the front of the hatch, flush with the base bottom and flush with the top hatch sheet. A laser cut hole is provided in the base for this dowel but it is now necessary to complete the hole through the hatch stringer and top sheeting. This hole could be made by simply using a 5/16" drill bit. But a much neater way is to sharpen the inside edge of a piece of 5/16" dia. brass or aluminum tubing and use it to complete the required hole. Insert the tubing into the hole in the bottom of the hatch and twist it to cut through the hatch stringer and sheeting. It helps to hold the hatch against a piece of plywood when cutting this hole to minimize or eliminate tearing of the sheeting.

When the hole is complete, glue the 5/16" dowel in place into the hatch. Sand the bottom of the hatch base smooth where the dowel exits. Turn the hatch over and lightly sand the dowel end smooth with the top sheet. Fit the hatch back in place onto the fuselage. The hole in the dowel should line up with the 4-40 blind nut previously installed in the forward hatch mount. Use the 4-40 x1" nylon bolt in your kit to secure the hatch to the fuselage.

69. Refer to your Key To Laser Cut Parts section to locate the Stab and Fin Filler parts. Also locate the two balsa tapered fin and fuselage fairing blocks. The two fillers will temporarily take the place of the fin and stab to allow exact shaping and sanding of the fairing blocks at the rear of the fuselage. Use a few dots of CA glue to temporarily attach the stab filler to the top of SM (place the CA dots nearer to the fuselage sides). Apply glue along the bottom (only) of the fin filler part and glue it to the top of the stab filler, at 90 deg. upright, aligned directly with the center of the top of the fuselage (as you would align the fin when gluing it in place). Apply a few dots of CA to the bottom and inside edges of a fairing block and tack glue it in place to the stab and fin fillers. Install the opposite fairing block in the same way.

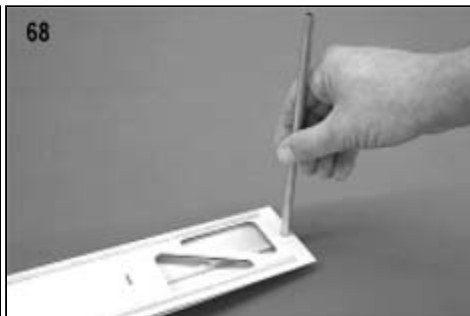
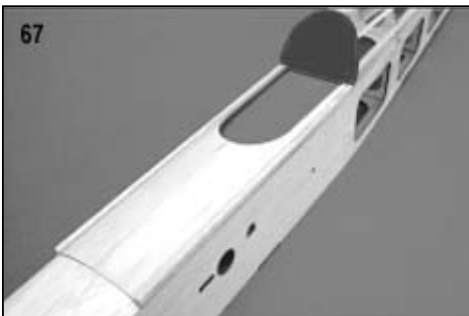

70. Use a razor plane or hobby knife to roughly carve the fairing blocks to match the lines of the fuselage. Use 80 grit sandpaper to further shape the fairing blocks to the cross section shape shown on the plans. When the shape is close, use 220 grit sandpaper to sand the rear stringer area and the fairing blocks smoothly together. Done properly, the whole thing looks almost one-piece.



71. With the canopy hatch on the fuselage, use a sanding block and 80 grit sandpaper to sand the Canopy Hatch, F-4 Cap and F-4T formers to matching, uniform shape. Be careful here to avoid changing the shapes of these formers. The idea is to maintain their elliptical shapes while matching their outlines. Use a sanding block to lightly sand the 1/4" sq. balsa spine to the profile shown on the plans. Use a sanding block and 220 grit sandpaper to sand the fuselage sides smooth. Doing this automatically sands the two lower side stringers to shape. Finally, use a sheet of 220 grit sandpaper to sand the stringers and filler blocks to their final shape. Be careful to sand this area uniformly.



72. As shown on the plans, use 3/32" scrap balsa to add fillers between each stringer, at the front and rear. A "Dremel Tool" and drum sanding bit will quickly radius their edges. Lightly sand these fillers smooth to the stringers and to match the front and rear cross sections. The shaped and sanded fin and fuselage blocks are now removed. Use a single edge razor blade to pop loose the stab filler from the top of FSM - the whole assembly should come loose. Use the same blade to now pop loose the two individual balsa filler blocks - set these aside for later use. The stab and fin sanding fixture can be thrown away.



73. With the exception of mounting the stabilizer, fin and fairing blocks, the basic fuselage is complete and ready for final sanding. Use light weight filler to patch any holes, dings, etc. Use your sanding block and sandpaper to now sand the fuselage smooth. As shown on the plans, we sanded our fuselage with rounded edges on the bottom and at the nose. Take your time and do a good job.

At this point you need to make a decision regarding the covering technique for this model. We are aware that some modelers prefer to cover the stabilizer, fin and fairing blocks separately - off the fuselage - and glue them in place afterwards. While this technique may work for some, we prefer to glue these surfaces in place first, before covering and then cover the fuselage, stab and fin as a single unit. The following instructions assume that you will proceed in this manner.

74. Locate the 7/8" dia. x15-5/8" aluminum wing joiner tube and the 3/16"x6" hardwood dowel from your kit box. Use a razor saw to trim the dowel to a length of 4-1/4". Lightly sand both ends to radius their edges. Insert the dowel into the rear 3/16" dia. hole, in the side of the fuselage, beneath the canopy area, through the opposite fuselage side. Center the dowel to leave 1/2" exposed on each side of the fuselage - DO NOT glue in place. Insert the aluminum tube wing joiner into the fuselage receptacle, roughly centering it. Take one wing panel and insert the aluminum tube into its female receptacle, sliding it in place all the way to the exposed rear dowel. Insert the dowel into the corresponding hole in the wing root and press the panel in place to the fuselage side. Repeat this procedure with the opposite wing panel.

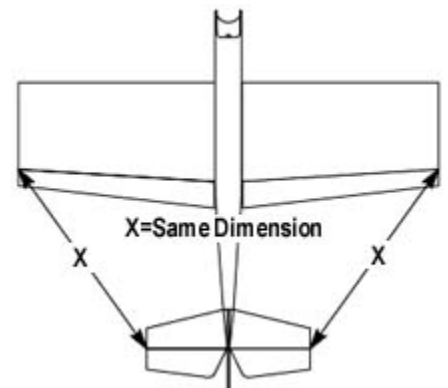

With the wing panels now in place, check their fit at the roots where they contact the fuselage. They should fit flat to the sides with little, if any, gaps. If the main aluminum wing tube is too long, causing a gap, remove the tube and trim it slightly for a good fit. Place the model on your bench, nose pointed away from you. Place the stabilizer on the fuselage and center it. Use pins to secure the stab in place. Use a measuring tape to measure the distance from the left trailing edge tip of the stab to the left trailing edge tip of the wing. Now make the same measurement on the right side of the model. The two measurements should be the same. If not, adjust the stab accordingly. Once the alignment is correct, use a pencil to mark the location of the fuselage sides onto the bottom of the stab.

75. The stabilizer is now be glued in place to the fuselage (for a little working time, we suggest 5-minute epoxy for this step). Apply a thin layer of glue to the fuselage stab mount (FSM) and also to the leading edge of the stab, where it contacts F-7. Position the stab in place, lining up the lines on its bottom side with the fuselage sides. Pin or use weights to hold it perfectly flat to the fuselage. Now back away a few paces and sight directly at the rear of the model. Is the stab tilting left or right compared to the wing panels? If so, use a little masking tape to hold it in the correct position and allow the glue to cure.

76. Glue the vertical fin in place to the top of the stab and the back of F-7, with the tailpost glued into the fuselage, between the sides (we suggest 5-minute epoxy for this step). Trial fit the fin in place and trim as required to achieve a perfect fit. Apply a thin layer of glue to the bottom of the fin and its lower leading edge, where it contacts F-7. Also apply glue to the sides and bottom end of the tailpost - not too much. Position the fin in place onto the stab and into the fuselage - wipe off any excess glue with acetone. Visually align the leading edge of the fin with the center of the 1/4" balsa spine/stringer in front of it and pin in place. Use a 90 deg. triangle to position the fin at right angles to the stab and use tape to hold the fin in position. Allow the glue to cure and remove the wing panels from the fuselage.

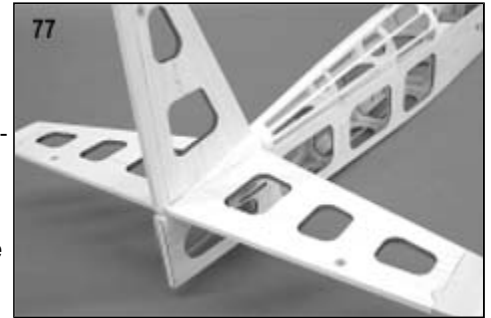

77. Before gluing the left and right fin fairing blocks in place, use a single edge razor blade to carefully notch the fin tailpost to clear the elevator joiner wire. This notch should be cut to the trailing edge of the stabilizer and 1/4" width. Once satisfied, glue the fin fairing blocks in place to the fin, stab and back of F-7. Use a small sanding block with 220 grit sandpaper to blend the fairing blocks smoothly to the contours of F-7.



78. Use the 6-32 x3/4" bolts provided to attach the two motor mount arms to the firewall. Without the muffler installed, place your engine onto the motor mounts and locate it to the previously drilled holes with at least two of 6-32 x1" bolts (without nuts). You will likely note that in order for your engine to fit in place with the muffler attached, the right fuselage side must first be trimmed to accept the manifold. We suggest about 1/8" clearance from the manifold. Use a pencil and a short straight edge to mark the fuselage side for trimming. Remove your engine and trim away the fuselage side as required. Mount the muffler to the engine and place it back on the mounts to check the clearance.



Some of the later two-stroke engines, with rear mounted remote needle valves, may require a hole in the left fuselage side for clearance. If your engine has this configuration, measure and drill the required hole. When these two issues have been taken care of, lightly sand these areas for covering.

COVERING

The SOMETHIN EXTRA really lends itself to a wide variety of color schemes. You may even want to cover yours in a scale color scheme as used on one of the many full-size Extra aircraft. Whatever the colors you choose for your model, remember that you will really appreciate a strongly contrasting scheme, in order to keep good visual reference on the model during extreme maneuvers.

To minimize weight and enjoy the full potential of this model, it should be covered in a good quality, light-weight iron-on film, such as SIG Supercoat covering products. If you intend to use two contrasting colors, you will require at least two rolls of covering material - typically one for the base color and the other for the trim color.

NOTE: If you choose to use another brand of covering material, follow the manufacturer's instructions for best results. Different brands of covering have different handling characteristics and application temperatures. However, the basic techniques in applying any brand of iron-on covering film are fairly similar. We would suggest the use of a temperature gauge to set the temperature of your iron to those suggested by the manufacturer (200 deg.F. for SIG Supercoat covering).

Surface Preparation

No matter what brand of covering you decide to use, the surface of your uncovered model directly affects what the covering job will look like when you are done. Poor workmanship will show right through. Now is the time to carefully inspect the surface of the entire model. Carefully sand any mis-matched sheeting joints smooth and use a good quality, light weight filler to take care of any dents, nicks or dings. The entire model should be final sanded with 220 grit sandpaper, progressing to 360 grit. The surfaces to be covered must be clean, dry and dust-free. Use a good quality tack rag and/or compressed air to make sure the model is completely dusted. We would also suggest that you make sure the physical area where you will be covering the model is as clean and dust-free as possible.

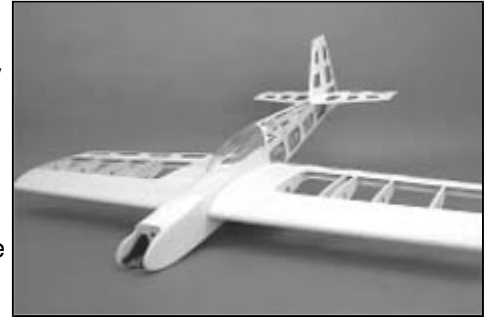

BUILDERS TIP: We suggest that you DO NOT seal the inside of the tank compartment before you cover the fuselage. Applying a sealer of any kind (epoxy resin, etc.) to the inside surface of the wood prevents heat from passing through it and can cause bubbling. Even though it is a bit more difficult, seal the tank area after the fuselage is covered.

The canopy/hatch (without the canopy in place), rudder, elevators and ailerons should all be covered separately and installed only after the entire model is covered. Once the control surfaces have been covered, the previously cut hinge slots should be located and opened with your hobby knife and a #11 blade.

A two-color trim scheme, such as the model shown on the cover of this kit, is fairly easy to accomplish. In the case of the wing panels, stabilizer and fin, we used the plans themselves to develop the color separation lines (patterns). These patterns were drawn on drafting vellum, directly over the plans, taking care to keep the color seams over solid wood. The pattern was then taped over both colors of covering film (one underneath the other) and cut using a metal straight edge and a hobby knife with a sharp #11 blade. This technique provides perfectly matched pieces of covering. The rear piece is applied first, followed by the forward piece with an overlap of approximately $3/16$ ". Working in this manner, using the plans as a pattern guide, practically insures a well matched, symmetrical covering job.

Once the model is covered, take a little time to carefully go back over all of your work. Make sure all the seams are attached and adhered and that there is no loose covering. Next, use a sharp #11 blade to open up all of the holes and slots that have been covered; hinge slots, hardpoint holes in the stab, fin and fuselage, hardpoint hole in the canopy hatch, bolt holes in the landing gear block, etc. The two J-hooks can now be screwed in place into the W-1 wing root ribs. Use epoxy to glue the $3/16$ " dia. x4- $1/4$ " rear wing locating dowel in place into the fuselage and up against the bottom of the servo tray, leaving $1/2$ " of its length exposed on each side of the fuselage.

BUILDERS TIP: The #1 reason for sagging covering, even after shrinking with heat, is internally trapped air. In the case of this particular design, where all of the control surfaces, including the stabilizer and fin are lightened with cut-outs, this can be an annoying problem. The answer is to ventilate each of the lightening hole bays in each part. This is quickly done using a hand-held twist drill with a $1/16$ " drill bit installed. Simply drill a $1/16$ " dia. hole through the trailing edge of the stab and fin, into each lightening hole - carefully centering the bit as you go. Starting at the leading edges, do the same thing to the rudder, elevators and both ailerons. When covering these surfaces, start with the bottoms of each. Once the covering is on and wrapped around the leading and trailing edges, use the sharpened end of a piece of $1/16$ " music wire to poke through each of these now-covered vent holes. Cover the tops of these surfaces and again poke through the drilled vent holes. Now when you use an iron or a heat gun to shrink these covered but ventilated surfaces, the covering will shrink tight and stay that way.

BUILDERS TIP: An alternative method to use when opening small round holes beneath covering film, is to briefly heat the tip of a small diameter Phillips screwdriver with a butane torch. Then simply press the tip of the screwdriver to the covering film, directly over the hole. The covering will melt around the edge of the hole, sealing it and leaving a perfectly round opening.

The engine compartment (firewall, fuselage sides and bottom sheeting) must now be sealed. We used SIG Polyester Finishing Resin (SIGFR001) to completely seal the wood in this area. Brush resin just over the edges of the trimmed covering material to seal it as well. Allow the resin to cure and sand it lightly. You can now paint the engine compartment with a complimentary color for your covering scheme or simply use flat black or white SIG Butyrate Dope.

Your kit is supplied with a sheet of SOMETHIN EXTRA logo transfers in both black and white. This allows you to use the white logo against a dark background or the black logo against a light background, depending upon your choice of color schemes. These self-stick transfers are not die-cut so you must cut them from the sheet. We suggest using a sharp #11 blade and a straightedge to do this. Once the transfer is cut out, spray a little glass cleaner onto the area where it is to be applied and carefully lay the transfer in place. The glass cleaner allows you to position the transfer accurately.

Use a soft piece of balsa as a squeegee, pressing the transfer in place, removing any bubbles. Be sure to get all of the liquid out from under the transfer. The two round transfers are the fuel and oil caps and they are positioned in place along the centerline of the fuselage, ahead of the canopy.

Installing Easy Hinges

SIG's famous Easy Hinges have been included with your kit to hinge all the control surfaces. Each ultra-thin hinge is actually a three-part laminate - a tough plastic inner core sandwiched by an absorbent wicking material. They have been chemically treated to slow down the reaction of thin CA glue (normally instant), to allow the glue time to soak all the way to the ends of the hinge and into the surrounding wood. Once the glue has set, the hinge cannot be pulled out of the structure without also tearing the surrounding wood out with it. All surfaces should be covered before hinging.

79. Begin by inserting six (6) Easy Hinges halfway into the hinge slots in the trailing edge of the stabilizer. Carefully slip each exposed hinge end into its corresponding slot in the elevators (make sure you have the elevators right side up, with the control horn holes on the right side of the fuselage). Snug the elevators up to the stabilizer.
80. To set the hinge gap, deflect the elevators to the maximum amount of their movement, while firmly holding them to the trailing edge of the stab. For best control response, the gap between the stab and elevators should be as small as possible but big enough to allow full, non-binding movement. Starting at either tip, hold the elevator in this fully flexed position and apply three or four drops of THIN CA glue directly onto the exposed hinge at the center line. The glue will wick into the slot as it penetrates both the wood and the hinge. Go to the opposite stab/elevator tip and repeat the process. Work inward toward the fin and apply glue to the remaining hinges on that side. Turn the assembly over, flex the elevators in the opposite direction and again apply three or four drops of glue to each exposed hinge at the center line. Keep a little CA debonder handy to wipe off any excess glue. The CA will need to cure for 3 to 5 minutes. When it has set, flex the elevators to their full deflection a couple of dozen times to reduce stiffness.
81. Hinge the ailerons to their wing panels using the same method as the elevators. Again, be careful to make sure that the correct aileron is hinged to its correct wing panel (control horn holes on the inboard side of W-3). NOTE: The rudder will be hinged, using the same methods in this section, after the tailwheel has been installed in the FINAL ASSEMBLY section.

FINAL ASSEMBLY

Canopy

Some builders may wish to install a pilot. If so, it should be installed now. We also like this look and chose to install a "Williams Bros." 2-5/8" Sportsman Type pilot bust in our prototypes. This size is correct for the Somethin Extra but is too tall for the available area. We simply trimmed the bust to fit beneath the canopy, glued a lite ply base inside the bust and used epoxy and a sheet metal screw through the bottom of the canopy hatch to hold the pilot securely in place.

- 82a. Using the disclosure lines molded into the canopy, cut away the excess material using long scissors. Take your time and be as neat as possible. After trimming, use a sanding block to smooth the edges, being careful not to scratch the plastic. Test fit the canopy in place. As shown on the plans, the rear edge fits over the top of the Canopy Hatch former with a little of it protruding back over the F-4 Cap former.
- b. Hold the canopy in place with pieces of masking tape and use a fine tip marker pen to draw a line around its edge, directly onto the covering. Remove the canopy and use a #11 blade and your hobby knife to cut away a 1/16" wide strip of the covering on the hatch, just inside of the line just drawn. Use glue especially made for attaching canopies, such as "RC-56" (DO NOT use CA glue) and glue the canopy in place to the exposed wood in the 1/16" wide strip and to the Canopy Hatch former. Use a damp paper towel to wipe off any excess glue, tape the canopy firmly in place and allow to dry completely. Trim tape can be used to outline the canopy. Adhesive backed covering material, in a color matching the airplane, could also be used for a more one-piece look.

Tailwheel

At this point, your rudder should be covered with the hinge slots cut, ready to install.

- 83a. We used a "Klett" 1" dia. tailwheel on the model shown on the box. There are many small diameter tailwheels available, all with surprisingly different weights. Use one that best fits your weight and balance requirements (see Center Of Balance) section. The wheel can be simply attached using a 1/16" wheel collar. A neater look results from soldering a small washer in place to retain the wheel and then grinding the wire flush with the washer.

- b. With the tailwheel in place, the rudder can now be hinged to the vertical fin and fuselage. Follow the directions given in the INSTALLING EASY HINGES section.

Tail Supports

The tail support system used on the Somethin Extra provides an added measure of support and rigidity to the stab and fin. As it does for full scale aerobatic aircraft, this system allows the model to be flown through extremely violent maneuvers without being concerned with the integrity of the tail group. It is easy to make and looks very nice on this particular model. We would urge you to include this support system on your model.

- 84a. From your kit contents, locate and have ready four (4) 2-56 x10" Control Rods (threaded one end), four (4) Solder Links and four (4) 2-56 clevises. Use the full-size Cross Section at F-7 drawing on the plans for patterns and cut the two top support rods (7-3/4" long, each) and the two bottom support rods (6" long, each).

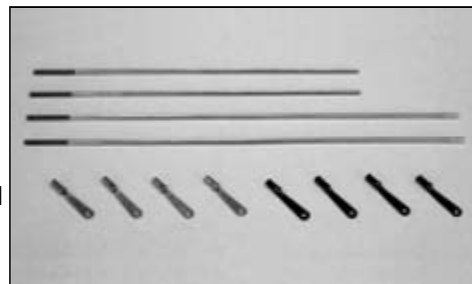

- b. As shown on the plans, both the solder links and the clevises need to be modified by cutting off the pinned arm of each, leaving only the arms with holes. This is easily done with a "Dremel Tool" and a carbide cut-off wheel.

- c. Starting with the two upper supports, solder a solder link to the top unthreaded ends of each of the two rods. Using the plans as a pattern and a pair of pliers, bend part of the solder links arm to fit flush to the side of the fin, at its hardpoint. Thread a clevis onto the threaded ends of each rod. As shown on the plans, use pliers to bend a part of the clevis arm to sit flush to the top of the stab. Use a 2-56 x3/8" bolt and nut, provided in your kit, to temporarily hold the two rods in place to the fin at the hardpoint - do not tighten yet. Thread the clevises in or out to match the holes in their arms with the holes in the stab hardpoints.



- d. The two lower support arms are made in the same way. The only difference is that the inboard solder link arms will overlap each other and be attached to the fuselage with a single 2-56 x3/8" bolt passing through the holes in each link and into the hardpoint at the bottom rear of the fuselage.

- e. When the support arms are made, they can be mounted in place to the fin, stabilizer and fuselage bottom. We suggest using a thread lock product on each of the 2-56 bolts before assembly. Doing this minimizes vibration problems.

BUILDERS TIP: For a really nice look, use a good metal polish, such as "Simichrome" or "Flitz" to polish these support wires and solder links to a high luster, chrome-like finish.

Landing Gear And Wheel Pants

The unique landing gear used with the Somethin Extra design looks great when dressed up with the wheel pants provided in your kit. These wheel pants are not difficult to assemble, add a great deal to the overall look of the model and work extremely well on either paved or grass flying fields. Use these steps to produce a very tough, functional and nice looking landing gear set for your model.

- 85a. With the exception of the wheel pants, ply wheel pant mount, 4-40 x3/8" bolts and the 4-40 blind mounting nuts - install your 2-3/4" dia. main wheels to the aluminum landing gear using the hardware shown in the cross section detail drawing on the plans and supplied in your kit. When properly mounted, the wheels will turn freely but will not have excessive side play on the axles.



- b. Locate the left and right sides of each wheel pant. Apply thick CA glue to the edge of one pant half and glue it to its mate. Do this carefully, matching the sides as closely as possible. Hold the parts firmly together and spray accelerator on the joint. Use your "Dremel Tool" and a drum sander to carefully clear out the molded-in wheel clearance area at the bottom - do not take out too much, it is better to sneak up on this opening. As you clear these openings, periodically check the fit by placing the pant over the tire.



c. To fit the pant over the wheel and against the aluminum landing gear, it is necessary to cut a vertical slot into the lower inside face of the wheel pant, at the location of the axle. The slot allows the pant to fit over the wheel, down onto the 6-32 hex nut which is against the outside face of the aluminum landing gear. This slot needs to be the same width as the hex nut (5/16" wide) and approximately 3/4" depth. It is easiest to use a pencil and a small straight edge to first draw the slot onto the wheel pant. Use a sharp #11 blade in a hobby knife to carefully cut this slot. To fit the hex of the nut at the top of the slot, cut a peak at the top, allowing the hex nut to nest in place. Continue trial fitting in place until 1) the wheel clearance cut out in the pant bottom clears the wheel and 2) the slot fits nicely over the hex nut and against the aluminum landing gear.



d. Attach the aluminum landing gear to the fuselage, using the three (3) 6-32 x1/2" round head bolts supplied. Place the fuselage on your work bench with the tail wheel in place on its strut. Fit the wheel pants in place, visually lining them up with the fuselage - level, as shown on the plans. From the back side of the aluminum landing gear, use a pencil to mark the two required mounting holes - just above the axle - onto the wheel pant. Remove the pant from the landing gear.

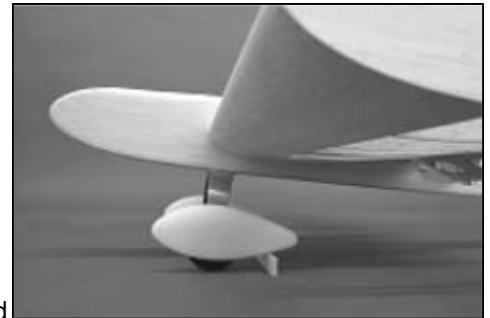

e. Accurately drill two 7/64" dia. holes through the pant, at the marks just made. Locate the two (2) ply wheel pant mounting plates, four (4) 4-40 x3/8" round head bolts and four (4) 4-40 blind mounting nuts from your kit contents. As shown on the plans, one of these plates is used inside each pant as a doubler. The mounting plates need to be prepared for installation by first using a sanding block to slightly bevel their lower, inside surface to conform to the inside of the wheel pant - see cross-section on the plans. Do this now. Apply thick CA glue to the outer surface of the 4-40 blind nuts and insert them into the two holes in each mounting plate. Use a hammer to tap them into the mounting plate.



f. Apply glue to the inner face of the mounting plate and glue it inside the wheel pant, with its two mounting holes lined up with the two holes drilled in the pant - use the 4-40 x3/8" bolts to tighten the plate to the inside surface of the pant.

g. Note that if any of the ply mounting plate is exposed in the pant slot it needs to be trimmed away with a sharp #11 blade to match the slot sides in the pant. Trial fit the wheel pants in place, using the 4-40 x3/8" bolts to mount them to the landing gear. The pants should mount easily, be aligned with each other and be easily removable.

h. Remove the wheel pants from the landing gear and prepare them for finishing. Use a sanding block and coarse sandpaper to smooth the joint seams. If filler is necessary for any reason, try 5 or 15-minute epoxy glue and micro balloons. Sand the pants completely with 220 grit sandpaper and apply a good primer, such as "K&B". Use 400 wet or dry sandpaper (wet) to sand the pants smooth and ready for paint. You can use almost any kind of fuel proof paint to finish the pants. We have used and can recommend paints such as SIG Supercoat dope and "K&B" epoxy.

i. The finished wheel pants can now be mounted to the landing gear with the 4-40 x3/8" bolts. We suggest using a thread locking material to eliminate vibration problems (such as "Loctite" Removable Threadlocker 242, Red).

BUILDERS TIP: As shown on the model on the box, the aluminum landing gear has been polished. This is a nice look that can be done to your landing gear. Start by sanding all of the gear's edges smooth with crocus paper. Now you can simply use a good quality aluminum polish such as "Simichrome" or "Flitz" and elbow grease to polish the gear. Another method is to use a bench grinder with a buffing wheel. Use a buffing compound to very quickly polish the gear to a super, chrome-like finish.

86. Locate the nylon control horns for the ailerons, rudder and elevator and the eight (8) #2 x1/2" pan head screws used to attach them. The two smaller control horns (one left and one right) are for the ailerons - mount these in place with the pan head screws. The rudder and elevator control horns are both larger. Mount these in place with the remaining pan head screws.

Engine And Tank Installation

87. With the tank compartment and fuel tank already prepared for installation (FUSELAGE CONSTRUCTION, Step 58a,b), the tank is now installed. Use a single 20" length of medium fuel tubing, folded in half. Insert the two 10" loose ends through the oblong hole in the front of the firewall and retrieve them through the tank compartment at F-2. Attach each fuel line to the fuel tank tubes. Insert the tank through F-2 and into the tank compartment while taking up the slack in the fuel lines as you progress. When the tank is in its final position, identify each fuel line (fuel, pressure) and cut the two lines apart. Leave these lines long until they are finally attached to the engine and muffler.
88. The 6-32 x3/4" round head bolts in your hardware package are used to attach the motor mount arms to the firewall. We suggest using a thread lock product, such as "Loctite" Removable Threadlocker 242 (Red) to eliminate vibration problems.
89. Use the appropriate 6-32 hardware (not supplied) to mount your engine - without the muffler - to the motor mount arms. We suggest using four (4) 6-32 x1" cap head bolts with 6-32 lock nuts to mount your engine.

With the tank and engine now in place, the throttle connections can be made to the engine and throttle servo in the following section of this manual. Once the throttle is connected to its servo and final adjustments made, the muffler, fuel lines, prop, and spinner can all be attached.

Radio Installation

If you have followed these instructions to this point, installation of the radio system becomes a simple matter of dropping the servos in place, securing them with the screws supplied with your system and then making the connections to each of the controls. If you are using one of the new generation of highly simplified computer radios - such as the Airtronics Radiant, Futaba 6XA, etc. - the radio installation becomes even easier with features such as total travel control, sub-trims, etc.

The receiver is mounted on top of the ply radio tray, just forward of the antenna tube exit hole. This places the receiver in the perfect position to accept the left and right aileron servo leads. We wrap our receivers in 1/4" foam, held with rubber bands. It is then secured to the radio tray with a single 10" nylon tie-wrap, through the holes provided in the tray. This method is simple, lightweight and effective. It also provides excellent access to the receiver servo receptacles, with the canopy hatch removed. The receiver antenna is fed through the antenna tube, exiting at the bottom rear of the fuselage. We would also suggest using the radio manufacturer's antenna strain relief, included with your system.

As shown on the plans, the switch can be mounted to the side of the fuselage, below the forward wing panel location. For a more professional look, you could mount the switch internally, on the floor of the fuselage, just behind the landing gear mounting block, activated with a length of music wire exiting the fuselage side - this is how we did it with our models.



Locating your battery pack in this design is very easy. Looking at the fuselage plan you can see that if you are using a typical 450 - 600 mAH battery pack in a flat configuration, it can be installed anywhere from directly beneath radio/servo tray, forward to the firewall, beneath the fuel tank. That is a lot of distance! Given that much latitude in locating the heaviest component of your radio system, achieving the correct Center of Balance should not represent a problem. Be sure to read the CENTER OF BALANCE section of this manual for more information.

When mounting the aileron servos into their bays in the bottom of the wing panels, you will likely find that you will need to add short (about 6") servo lead extensions to get the length needed to reach the receiver. If this is the case, be sure to secure the plugs with either tape or some other mechanical method to ensure they will stay plugged together. We also found that when installing our aileron servos, using hemostats to get the servo leads started into the wing tubes was helpful. Always use the rubber servo grommets and eyelets that all radio manufacturers supply with their systems.

Pushrod Assembly

90. Begin with the rudder and elevator pushrods - the instructions are the same for both. Locate the two 30" lengths of 1/8" O.D. nylon tubing, four (4) 10", threaded one-end metal pushrods, two (2) nylon R/C links and two (2) solder links. Cut 6-1/2" off the unthreaded ends of two 10" pushrods, leaving a length of 3-1/2" each. Smooth the cut ends and insert the unthreaded end of one of these into the end of a 30" nylon tube, right up to the threads. Grip the threaded end with padded pliers and thread it into the nylon pushrod about 3/16-1/4".

Thread one of the nylon R/C links onto the remaining threads, roughly centering it on the threads for later adjustments. This prepared end will be located at the control surface (rudder or elevator).

91. Prepare the two remaining 10" metal pushrods by cutting 8-3/4" off the unthreaded ends, leaving a length of 1-1/4" with threads on one end. As shown on the plans, solder a solder link onto the unthreaded end of the metal pushrod.

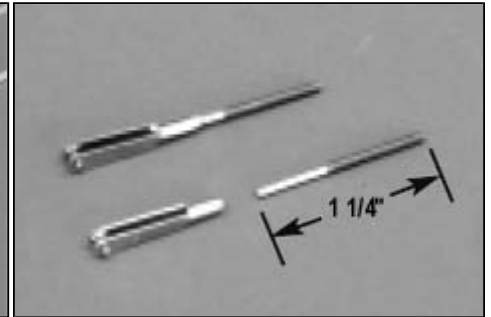
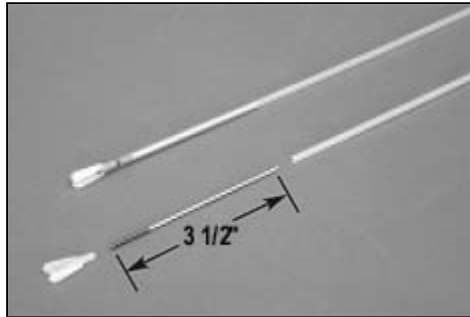

92. Insert the unprepared end of the nylon pushrod into the rear pushrod exit tube at the rear of the fuselage, all the way through the tube, into the radio compartment. Connect the nylon R/C link to the control horn on the rudder or elevator and neutralize the surface with tape or a fixture. Attach the solder link to the centered servo output arm. Mark the nylon pushrod for cutting at a point where it will accept about 3/8-1/2" of the metal pushrod threads. Remove the nylon pushrod from the fuselage and cut it to length at the mark just made. Thread the solder link and pushrod into the end of the nylon pushrod and remove the nylon R/C link at the other end - not the metal pushrod.



93. Re-install the nylon pushrod, this time through the tube in the radio compartment. Connect the solder link to the centered servo output arm. Thread the nylon R/C link back in place at the rear of the fuselage. Neutralize the control surface and attach the R/C link to the control horn.

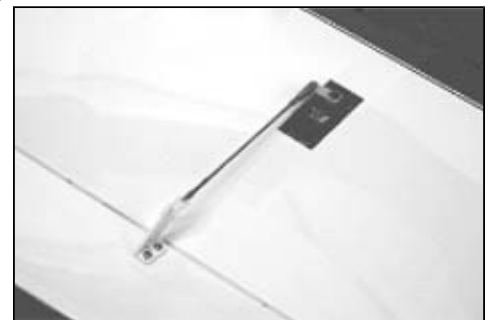

94. Aileron pushrods are next. Thread a nylon R/C link in place on a 10" metal pushrod, centering it on the threads for later adjustment. Attach the R/C link to the aileron control horn with the unthreaded end facing forward, toward the aileron servo. With the servo output arm centered, attach a solder link in place to the arm. Mark the metal pushrod for cutting, at a point where it will pass through the solder link. Remove the pushrod and cut it to length. Solder the link in place and reconnect the completed pushrod to the aileron servo and nylon control horn.

95. Locate the 18" length of metal throttle cable, a solder link, a nylon R/C link and the 2-56 x3/4" threaded brass coupler. Slide the brass coupler onto one end of the cable and solder it in place. Thread the nylon R/C link in place onto the threaded brass coupler. From the firewall side, insert the cable into the throttle housing tube and push it into the radio compartment. Turn your radio on and set the throttle stick to low throttle, with the trim lever centered. Push or pull the throttle cable to close the carburetor on your engine. Connect the solder link to the throttle servo output arm. Mark a cutting point on the cable that will allow it to be attached to the solder link. Remove the cable and cut it at the mark just made. Slide the trimmed cable back in place into the radio compartment and solder the link in place to the end of the cable. Connect the solder link to the throttle servo output arm and the nylon R/C link to the carburetor throttle lever. Use your radio to test the throttle action and adjust as required at the carburetor, using the nylon R/C link.

Set all flight surfaces to neutral. In the case of the ailerons, this would normally be a difficult job because of the thickness of the wing panels and the inability to sight down the trailing edge of each to see their relationship. However, we have included a laser cut Aileron Position Guide (APG) in your kit, which allows independent neutral positioning for each aileron.

The APG is simply held against the fuselage side, on top of the wing panel at the trailing edge. The aileron pushrod is adjusted to align the aileron parallel with the flat, at the rear of the APG part - simple and easy.

After the flight surfaces have been neutralized, take the time to fit each clevis with a short length of fuel tubing (medium is fine for 2-26 hardware) to keep the clevises firmly in place to each control horn and servo arm. This common safety practice has saved a lot of models in the past.



There are any number of different radio systems currently in use and on the market. Because of this, it is not possible to explain the optimum set-up of all these systems for this particular model. The following suggested control surface travel information is based upon our experience with the Somethin Extra. These suggested surface movements should be considered as a starting point. As your experience and confidence builds, these control movements can be increased to outrageous amounts, to really explore the model's (and your) capabilities!

Control Surface Travel Chart		
Surface	Low Rate Travel	High Rate Travel
ELEVATOR	1-1/4 up - 1-1/4 down	2 up - 2 down
AILERONS	1 up - 1 down	2 up - 2 down
RUDDER	1-7/8 left-1-7/8 right	2-1/4 left- 2-1/4 right
THROTTLE	full range of travel	

NOTE: These measurements were taken as follows:

- Aileron travel measured at the inboard trailing edge.
- Elevator travel measured at the widest inboard trailing edge.
- Rudder travel measured at the widest lower trailing edge.

If you are using a computer radio, the following information may be of help to you. Listed and explained below are types of control surface mixing that would be desirable on this type of model and the effect they have on the flight performance of the SOMETHIN EXTRA

Control Surface Mixing		
Mixing	Control Surfaces	Effect
FLAPERONS	AILERONS	Using virtually any of today's modern computer radios and two separate aileron servos, it is possible to use the ailerons as flaps. In actual flight, lowering both ailerons as flaps typically causes the model to pitch down, requiring some corrective up elevator input to maintain level flight. Some transmitters have a rotary Flap knob, allowing the flyer to select the best flap position for any given wind conditions. With each aileron servo plugged into a separate channel in the receiver, lowering both ailerons as flaps still allows independent movement of each aileron to control roll. This is a versatile mixing feature as long as the pilot maintains elevator input as required.
ELEVATOR-FLAP	ELEVATORS and FLAPS	Elevator to Flap mixing is also a good feature. It interfaces the elevators to the flaps, allowing both surfaces to work together. When mixed together, the flaps travel downward while the elevators travel upwards at a programmed rate. Likewise, deploying the flaps upwards causes the elevators to travel downwards at a programmed rate. This mixing feature can be used to give your SOMETHIN EXTRA the ability to perform incredibly sharp turns and super tight loops.
PRE-SET SWITCH	FLAPS and ELEVATORS	As mentioned in Note #1, some radios have rotary knobs for a flap channel and some have 3-position switches allowing pre-set flap and elevator positions and some systems have both these features. The 3-position switch typically allows for three different flap positions. For example: Switch setting #1: Raise the flaps 10 deg. or so, causing the flaps to act as spoilers on a sailplane, spoiling some of the wing's lift. This will cause the SOMETHIN EXTRA to make faster descents for those quick take-offs and landings sometimes required in fun fly contests. Switch setting #2: With the switch in this position, the flaps are held in the neutral position, with the exception of the elevator to flap mixing for normal flying. Switch setting #3: Lowers the flaps to about 30 deg. This allows the model to make extremely slow landings or to even hover or appear to fly backwards in certain wind conditions.

Double check your entire radio installation and remedy any problems now. Make sure that all five servos have their output arm screws back in place and tightened. We also suggest that you periodically check the available voltage in your receiver and transmitter packs with a good ESV to avoid battery related problems. Last, no matter how good you may think your radio system is, make it a routine part of your pre-flight procedures to always perform a thorough range check before every flying session.

Center Of Balance

Like all R/C models, the Somethin Extra was designed to be flown with the proper Center of Balance (or CG). As shown on the plans, the CG falls exactly in the center of the 1/4" wing spar, or 3-1/2" back from the leading edge. As previously mentioned, this design allows for a relatively huge shift in the location of the airborne battery pack. However, if for some reason you find that your model is still either nose heavy or tail heavy, consider some of the following suggestions before resorting to non-functional lead weight.

- **Wheels:** There are 2-3/4 dia. wheels suitable for this design that are extremely light (such as the Dave Brown Treaded Lite Wheels) and heavier wheels from other manufacturers. This is a great way to adjust and help correct an out-of-balance model.
- **Tailwheels:** A simple way to help control balance is to consider ultra-light plastic tailwheels to cure a tail heavy condition or much heavier tailwheels to help with a nose heavy situation.
- **Spinners:** Like the wheels, there are very light 2-1/4" dia. plastic spinners and considerably heavier metal spinners of the same diameter - yet another way to control the CG.
- **Propellers:** Some of the more popular composite plastic props can be fairly heavy in contrast to the considerably lighter wood propellers with the same diameter and pitch. This is another good place to control the balance of your model.
- **Heavy Hubs:** Need a little more weight in the nose? Consider using one of the many Heavy Hub propeller hub products sold by Harry Higley & Sons, Inc.
- **Battery Packs:** If your smaller 500 mAH pack is not helping much in getting the model to balance, consider moving up to a larger, somewhat heavier pack. Functional weight is the best kind!

In the unlikely event that your model is still out of balance, then you will probably have to resort to the use of lead weight. If so, we caution you to make very certain that the weights are securely attached to your model. The Somethin Extra is capable of extreme high-G maneuvers that could possibly dislodge improperly attached lead weights.

Last, we also suggest that you balance your model laterally. To do this, use light line or string to suspend the assembled model inverted, from a front center and rear center point on the fuselage - typically from the engine's prop shaft in the front and the tailwheel wire at the rear. Properly balanced laterally, the wings would remain level. If the airplane is heavier on one side than the other, the wing on the heavy side will hang lower. This can have a negative effect on how this or any other model flies and will show up in certain maneuvers. It should be corrected. The quickest fix is to add small stick-on weights to the lighter wingtip until model hangs level. A neater method is to cut a small hole in the wingtip, place the lead inside securely and recover the area. No matter how you do the job, a laterally balanced model always performs better and is well worth the effort.

FLYING

The SOMETHIN EXTRA is most certainly not a beginner's model. It was designed as an all-out aerobatic aircraft with all of the inherent attributes of those types of airplanes. If this is your first aerobatic model and you have relatively little actual air time, we would urge you to seek the assistance of a qualified R/C pilot to help you through the first few test flights.

Keep the ailerons and elevators in their low rates. Once airborne, get to a reasonable altitude before inputting any trim changes. Once the model is trimmed for straight and level flight, begin getting the feel for the way it flies. At an altitude of about three mistakes, you can begin exploring its ability to loop, roll, etc. When you are more comfortable (typically within minutes), go to high rates and begin to enjoy this model as it was meant to be enjoyed! This thing will perform maneuvers that are not yet even named! Explore the model's ability to spin - upright and inverted and while you are at it, check out the stall speed while still at altitude. When you are more familiar with the SOMETHIN EXTRA, start playing with the flaperons. You will not believe what you can get this model to do!

FLYERS TIP: We suggest that you do not lower the flaperons above 1/2 throttle. At higher speeds, lowering the flaps may cause sudden pitch changes that may be difficult to correct at low altitudes.

One word of caution is appropriate here. This design has a tendency to make you feel so confident that you may begin to fly it too close to you and/or the ground. The airplane has the ability to recover from virtually any maneuver instantly but a point could be reached where you may run out of altitude and ideas all at once. You also need to get yourself comfortable with the shape and color of your model during some of the wilder maneuvers. Knowing which side is up and the direction of flight is always a good thing. If your engine quits for any reason, be aware that the SOMETHIN EXTRA flies very well dead-stick. However, the thickness of its wing does not allow it to penetrate very well in high wind, dead-stick conditions. If the engine quits and you have some distance to travel back to your field, keep the nose down, the speed up and avoid turns.

Landing this design is super easy. The first few times, without flaps, keep a little power on the engine to keep the model moving. It can be flown right down to the ground, landing on the mains with a very short roll-out. With a little experience and using flaps, you can consistently land this model in exactly the same place every time.

Last, this design places a real premium on a great running engine. If you are consistently having engine problems, take the thing out of the model and either fix it on the bench or replace it with a good engine. This is not an airplane that is going to make a bad engine look good. Nuff said.

WARNING! THIS IS NOT A TOY!

Flying machines of any form, either model-size or full-size, are not toys! Because of the speeds that airplanes must achieve in order to fly, they are capable of causing serious bodily harm and property damage if they crash. IT IS YOUR RESPONSIBILITY AND YOURS ALONE to assemble this model airplane correctly according to the plans and instructions, to ground test the finished model before each flight to make sure it is completely airworthy, and to always fly your model in a safe location and in a safe manner. The first test flights should only be made by an experienced R/C flyer, familiar with high performance R/C aircraft.

The governing body for radio-control model airplanes in the United States is the ACADEMY OF MODEL AERONAUTICS, commonly called the AMA. The AMA SAFETY CODE provides guidelines for the safe operation of R/C model airplanes. While AMA membership is not necessarily mandatory, it is required by most R/C flying clubs in the U.S. and provides you with important liability insurance in case your R/C model should ever cause serious property damage or personal injury to someone else. For more information, contact:

ACADEMY OF MODEL AERONAUTICS
5151 East Memorial Drive
Muncie, IN 47302
Telephone: (317) 287-1256

Customer Service

SIG MFG. CO. is totally committed to your success in both building and flying the SOMETHIN EXTRA design. Should you encounter any problem building this kit, or discover any missing or damaged parts, please feel free to contact us by mail or telephone.

SIG MFG. CO., INC. 401-7 South Front Street Montezuma, IA 50171-0520	SIG MODELER S ORDERLINE: (to order parts)	1-800-247-5008
	SIG MODELER S HOTLINE (for technical support)	1-641-623-0215
	SIG WEB SITE:	www.sigmfg.com

LIMIT OF LIABILITY:

The craftsmanship, attention to detail and actions of the builder/flyer of this model airplane kit will ultimately determine the airworthiness, flight performance and safety of the finished model. SIG MFG. CO's obligation shall be to replace those parts of the kit proven to be defective or missing. The user shall determine the suitability of the product for his or her intended use and shall assume all risk and liability in connection therewith.