

1/5th Scale SIGRC82

PIPER J-3 CUB



BUILDING and FLYING INSTRUCTIONS

Sig Mfg. Co., Inc....401-7 South Front Street...Montezuma, Iowa 50171



Introduction

Congratulations on your purchase of the 1/5-scale SIG PIPER J-3 CUB kit. This is a computer engineered laser-cut kit of America's favorite lightplane. Laser cutting is more expensive than the older methods of kit production, but it provides incredible accuracy and perfect parts fit. We believe that you will enjoy putting this kit together just as much as you'll enjoy its legendary flying characteristics.

The Piper J-3 Cub Story

The yellow Piper J-3 Cub is one of aviation's genuine classics. In the decades right before and after World War II, the Piper Cub was the most commonly seen lightplane at airports all over the country. It's been said that back then most people thought that every airplane flying was either a DC-3 or a Piper Cub. The J-3's charm and legendary flying abilities have made it one of the most famous, best loved airplanes of all time.

To understand the Cub's appeal, look back at aviation as it was in 1930. Lindbergh had crossed the Atlantic just three years earlier and made the world "air conscious". Airplanes were getting faster and more powerful every day. Air racing and distance records were front page news. But while the major aircraft manufacturers were busy pushing ahead the state of the flying art, thousands of prospective pilots with limited pocketbooks were being left behind. The cheap barnstorming Curtiss Jennys were gone, replaced by impressive but expensive airplanes of the Stearman and Stinson class. With the Depression on, many people wanted to fly but couldn't afford to. What general aviation needed was a simple, economical two-seat trainer!

The basic Cub design emerged in 1930 as the open cockpit Taylor E-2 Cub. It was the product of a fledgling company in Pennsylvania headed by designer C.G. Taylor and businessman William T. Piper. Taylor left the partnership in 1935 to start his own Taylorcraft company, but his self-taught design genius had made the E-2 a perfect foundation for Piper's business talents to expand on. In 1936, the J-2 Cub was introduced with an enclosed cabin and 40 h.p. engine.

Piper J-3 Cub owned by Les Gaskill/Ottumwa, Iowa



In 1937 a further improved version of the Cub was introduced, the legendary J-3. The Piper factory produced 14,125 model J-3 Cubs between 1937 and 1947. That made it the single most successful civilian airplane design up to that time. The popularity of the J-3 Cub was easy to understand. It provided airport operators with a low-maintenance, economical trainer that could survive most bad landings. America's weekend pilots found an affordable basic stick and rudder machine that set a new standard for fun and economical flying. The J-3 Cub was equally at home on wheels, floats, or skis, and it could be flown in and out of places the larger civilian airplanes couldn't get close to. Cubs also found work towing gliders and banners, doing small-field crop dusting, and even in air shows. Crazy "drunken" Cub acts, landing on moving automobiles and aerobatics in "Clipped Wing Cubs" are just a few of the things the J-3 could do to entertain the crowds.

Like Henry Ford and his Model T car, William Piper had a standard for factory paint jobs for the J-3 -- "You can have any color you like as long as it's yellow!" Standard factory markings were black lightning bolts down the fuselage sides, black registration numbers, and the Cub bear emblem. Today, it's hard to imagine a Cub painted any other way.



The Army used a version of the Cub, the L-4, for utility work during World War II. The Piper L-4 "Grasshopper" was little more than an olive drab J-3 with a greenhouse style cabin. Piper produced 5,673 L-4s between 1942-1945. They were used for observation, aerial photography, artillery spotting, as transports, and as ambulances.

Even though the Piper J-3 Cub has been out of production since 1947, they are still in great demand by pilots who want a superior, no frills, fun flying machine. As long as there are pilots around who still fly purely for the adventure of flight and who don't care about all the latest gadgets and dials, there will always be yellow Piper Cubs!

Hazel Sig's Clipped Wing Cub

In 1953, an aerobatic pilot named Earl C. Reed got FAA approval to shorten the wings of his Piper J-3 Cub for better aerobatic performance. Reed's modification was to take 40-1/2 inches (about 2-1/2 rib bays) off the inboard end of both the left and right wing panels. That shortened the standard J-3 wingspan of 35'-1-1/2" to 28'-5-1/2" and gave the airplane a faster roll rate.

Hazel Sig, co-founder of SIG MFG. CO., bought a well-used Piper J-3 Cub for pleasure flying in January of 1968. Carrying registration number N32629, Hazel's Cub had been manufactured in 1941 at the Piper factory in Lock Haven, Pennsylvania as a standard Piper J-3C-65 Cub, serial number 5498. The log book showed that the Cub had been covered with ceconite and painted with enamel in 1965, just three years before Hazel bought it. The ceconite and enamel turned out to be a bad combination. After the simplest aerobatics, the enamel began to crack and loosen from the fabric in several places.

It quickly became obvious to Hazel that the Cub was going to need recovering again in the near future, much sooner than should have been the case.

As it turned out, a late-summer 1968 wind storm brought the Cub's covering problems to a head. With the storm fast approaching and no hangar space available, Hazel quickly tied the Cub down outside. To keep the rudder from slamming from side to side in the gusty wind, she grabbed a roll of duct tape and taped the rudder to the fin. Needless to say the tape held perfectly during the storm, but when she tried to take it off later, huge chunks of enamel came off with it. The recovering project couldn't be put off any longer!

Hazel's Cub in 1968



After retaping over the bare fabric spots, Hazel flew the wounded Cub to the Ottumwa, Iowa airport. There the entire airplane was stripped of its covering and inspected. It turned out to be in worse shape than originally thought. The wooden wing spar had been damaged by mice and hastily varnished over in '65. The control cables were brittle. The engine needed an overhaul. And the list kept growing. The Cub needed to be completely rebuilt!

Hazel's Cub in 1968



Hazel, assisted by her husband Glen and SIG factory superintendent Maxey Hester, completely disassembled the J-3 and trucked it back to the SIG factory, where they worked on it through the winter. Since the airplane needed a complete overhaul, they decided to make it a Clipped Wing Cub using Earl Reed's FAA-approved plans and instructions. In addition to shortening the wings and struts, the steel tube fuselage was sandblasted and primed with zinc chromate. The wooden parts were repaired or replaced as needed. The airframe was then recovered with grade "A" cotton and painted with SIG SUPERCOAT MODEL AIRPLANE DOPE. When it came time for the color painting Hazel, Glen, and Maxey all had different ideas.

They had agreed on the sunburst pattern, but according to Hazel; "Glen wanted it to be red and white, Maxey like blue and white, and I thought yellow and white would look best. As you can see, Maxey is the one who actually loaded the spray gun." The Cub's Continental A65-8F engine was given a complete overhaul and modified to produce 75 h.p. instead of its normal 65. New cowlings, windshield, side windows, tailwheel, and metal prop were installed. Added "extras" like chromed cylinder heads and top shrouds, streamlined bungee covers, a personalized Cub bear emblem, radio gear, and a new interior made Hazel's Clipped Wing Cub one of a kind.

In the spring of 1969, the Cub was trucked back to Ottumwa airport for final assembly. Hazel made the first test flight herself and then flew the Cub back to it's home at SIG FIELD. Pilots who've had a chance at the controls of Hazel's Clipped Wing say it is the sweetest flying Cub they've ever flown. Most modelers feel the same way! Over the years, Hazel moved on to snappier and more powerful aircraft for her aerobatic flying, but none has captured the attention and affections of modelers worldwide as much as the little blue and white Cub. It's a very special example of America's favorite airplane!

Build A Standard J-3 Or A Clipped Wing Cub

You can build either a standard PIPER J-3 CUB (84-1/2" wingspan) or a CLIPPED WING CUB (68-1/4" wingspan) from this kit. All of the parts to build either version are included in the kit. The differences between the J-3 and the CLIPPED WING are clearly shown on the full-size plans and are noted in the building instructions. Decide which version you want to build and pay close attention to the instruction sequence as you proceed.

Engine Selection

Engine choices for the 1/5-scale Piper J-3 Cub are many. When selecting an engine, please keep in mind that the Cub is by nature a lightly loaded airplane meant to be flown slow. Over-powering this model is totally unnecessary and not at all recommended.

We've found that 4-stroke engines in the .45 - .65 displacement range give the Cub outstanding flight performance. It just looks and sounds "right" with a 4-stroke in the nose. Our preferred installation is to side-mount the engine.



Typically 4-strokes have an exhaust stack/muffler which is adjustable in direction, so there shouldn't be any special installation problems. The exhaust can be easily directed outside the cowling.

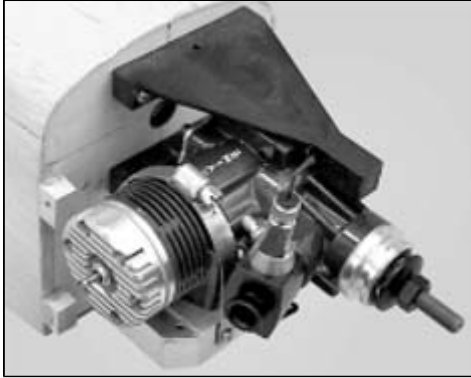

2-stroke engines also fly this airplane very nicely. Any plainbearing or bearing equipped .40 - .46 cu. in. sport engine would be a good choice. For example, a great choice would be the Irvine .46 engine. Like all Irvine engines, the .46 is powerful, reliable, and quiet.

Our preferred installation is to side-mount the engine. You can use the engine's stock muffler, but in most cases that will necessitate cutting away a large portion of the side of the cowling to clear the muffler. A better alternative is to use an "after market" muffler, such as the J'TEC #JTC605 Universal In-Cowl Muffler shown here. This type of muffler will be completely enclosed inside the cowling. Use rubber extensions on the exhaust tubes to extend them out the bottom of the cowl.

Whatever engine you choose, take the time to carefully break it in according to the manufacturer's instructions. A good running, reliable engine is a minimum requirement for the enjoyment of this or any R/C model aircraft.

Radio Equipment

The Piper J-3 Cub requires a standard 4-channel radio system and five standard servos. We have used and can highly recommend both the Airtronics and Hitec radio systems. For reference, this assembly manual shows the installation of an Airtronics radio system with standard servos. In addition, you will need two aileron 24" servo lead extensions and an aileron servo Y-harness for connection to the receiver.



Required Tools

For proper assembly, we suggest you have the following tools and materials available:

| | |
|--|---|
| Razor Saw | Hobby Knife with sharp #11 Blades |
| Scissors | Diagonal Wire Cutters |
| Masking Tape | Sandpaper and Sanding Blocks |
| Paper Towels | Heat Iron and Trim Seal Tool |
| Small Allen Wrench Assortment | Pin Vise for Small Dia. Drill Bits |
| Screwdriver Assortment | Pliers - Regular & Needle Nose |
| Power Drill With Selection of Bits | Soldering Iron, Solder and Soldering Paste Flux |
| A selection of glues - SIG Thin and Thick CA and SIG Kwik-Set 5-Minute Epoxy | |
| Clear Dope For Fuel-Proofing Engine Compartment | |
| Threadlock Compound, Such as Loctite® Non-Permanent Blue | |
| Dremel® Tool With Selection of Sanding and Grinding Bits | |



It has been correctly said that the difference between a good model and a great one is sandpaper and the knowledge of how to use it. In these instructions you will note that we often mention "sanding blocks". An assortment of different size sanding blocks are indispensable tools for all model construction. A sanding block will give you a much flatter, truer result than you would get with an unbacked, limp piece of sandpaper held in your fingertips. There are many styles of commercially made sanding blocks available in hobby shops, or you can make your own.

We suggest using 80 grit sandpaper during general construction, then switching to 220 or 360 grit for final sanding, before covering.

The following is a complete list of all parts contained in this kit. Before beginning assembly, we suggest that you take the time to inventory the parts in your kit.

| COMPLETE KIT PARTS LIST | | | | | | | |
|--------------------------------|---|---|--|---|--|---|---|
| Laser-Cut Balsa Sheets | | | | | | | |
| 1 | 3/32" thick Sheet #3: W-2 | 3 | 3/32" thick Sheet #4: W-4 | 2 | 3/32" thick Sheet #5: W-5, TB2 | 1 | 3/32" thick Sheet #6: J-3 Cub - Front Spar Web, Rear Spar Web |
| 2 | 3/32" thick Sheet #8: Aileron Top sheet | 2 | 3/32" thick Sheet #9: Aileron Bottom Sheet | 1 | 3/32" thick Sheet #10: Cabin Top Sheeting, F-1A , F-2, F-5A, Rear Center Web, Top Front, Top Rear, Window Frame, Window Front, Window Rear | 1 | 3/32" thick Sheet #11: Aileron Ribs, TB-1, TR-1, TR-2, TS-1, TS-2, TS-3, W-6 |
| 2 | 3/32" thick Sheet #12: J-3 Cub - Bottom Leading Edge Sheet | 1 | 5/16" thick Sheet #13: E-1, E-3, E-4, E-5, E-6, FN-1, FN-3, FN-4, S-1, S-4, S-5, S-6, R-9 | 1 | 5/16" thick Sheet #14: E-2, FN-2, FN-5, R-1, R-2, R-3, R-4, R-5, R-6, R-7, R-8, S-2, S-3 | 1 | 1/8" thick Sheet #16: Right Fuselage Side, Tail Mount |
| 1 | 1/8" thick Sheet #17: Left Fuselage Side, Tail Mount | 1 | 3/32" thick Sheet #18: Fuselage Doublers | 1 | 1/8" thick Sheet #19: F-5, F-6, Fuselage Bottom Rear | 1 | 1/8" thick Sheet #20: F-2 Angle Guide, Fuselage Top Rear, Tail Fairing |
| 1 | 3/32" thick Sheet #23: Cabin Window Doublers, Elevator Exit, F-6A, Rudder Exits | 2 | 3/32" thick Sheet #24: C.W. Cub - Bottom Leading Edge Sheet | 1 | 3/32" thick Sheet #25: C.W. Cub - Front Spar Web, Rear Spar Web, Triangle | | |
| Laser-Cut Plywood | | | | | | | |
| 1 | 1/8" Lite-Ply Sheet #1: W-1,W-3, CR-2 | 1 | 1/8" Lite-Ply Sheet #2: Cabin Floor Front, Cabin Floor Rear, F-4A, F4-B, Nose Top, Tank Floor, Window Braces | 1 | 1/8" Lite-Ply Sheet #21: Cabin Widows | 1 | 1/8" Lite-Ply Sheet #26: F-3, Hatch Dowel Support, Hatch Mount, Nose Bottom, Latch Pivot, Stab Mount, Tailwheel Mount |
| 1 | 1/8" Lite-Ply Sheet #27: Aileron Horn Mount, Center Section Web, F-7, Main Gear Doublers, Servo Tray, Servo Tray Doublers, Wing Tip | 1 | 1/16" Birch Ply Sheet #7: Servo Hatch, and Cabin Hatch Hard Points | 1 | 3/32" Birch Ply Sheet #15: CR-1A, Strut Mounts, W-1A | 1 | 1/4" Birch Ply Sheet #22: F-1 |
| Balsa Wood Sticks | | | | | | | |
| 13 | 3/32"x1/4"x36" Cap Strips, Fuselage Side Stringers | 5 | 1/4"x1/4"x36" Main Spars, Fuselage | 5 | 3/16"x3/16"x36" Rear Spars, Fuselage | 5 | 1/8"x1/4"x36" Wing Spars |
| 3 | 1/8"x1/4"x48" Aileron Spars & Fuselage Stringers | 4 | 1/8"x1"x24" Wing T.E. Cap & Aileron Cap | 2 | 5/16"x5/16"x36" Fin, Rudder, Stabilizer & Elevator | 2 | 3/32"x3/32"x36" Fuselage Corner Stringer |
| 1 | 1/2"x1/2"x36" Balsa Triangle: Firewall & Main Gear Braces | 2 | 36" long Pre-Shaped Leading Edges | | | | |
| Balsa Wood Sheets | | | | | | | |
| 2 | 3/32"x1"x36" Wing T.E. Sheeting | 4 | 3/32"x3/4"x24" Wing Aileron Bay Sheeting | 4 | 3/32"x3"x36" Wing & Nose Sheeting | 1 | 3/16"x6"x8" Main Gear Fairing |
| Balsa Wood Blocks | | | | | | | |
| 2 | 1/2"x1"x2" Wing Tip Block | | | | | | |
| Hardwood | | | | | | | |
| 1 | 3/16"odx6" Dowel | 3 | 1/8"odx6" Dowels | 1 | 5/16"odx1-1/2" Dowel with 5/64" id hole thru center | 4 | 1/4"x3/4"x7/8" Basswood Aileron Servo Mounts |
| 1 | 3/8"x3/8"x3" Basswood Cowl Mount Blocks | 1 | 1/4"x1/2"x16" Basswood Grooved Hatch Rails | 2 | 3/8"x3/4"x4-15/16" Basswood Grooved Landing Gear Blocks | 1 | 1/8"x1/4"x24" Spruce Fuselage Top Stringer |
| 4 | 1/4"x1/2"x24-1/4" Spruce Front Struts | 2 | 1/4"x3/8"x24-1/4" Spruce Rear Struts | | | | |
| Molded Parts | | | | | | | |
| 1 | .030" clear Molded Windshield | 1 | .015" clear Molded Right Side Window | 1 | .015" clear Molded Left Side Window | 1 | set Molded ABS Plastic: Dummy Engines |
| 1 | set Molded ABS Plastic: Dummy Engine Shrouds | 1 | Molded Fiberglass Cowling | | | | |
| Wire Parts | | | | | | | |
| 1 | 5/32" dia.x18-3/8" Formed Main Landing Gear | 1 | 5/32" dia.x20" Formed Landing Gear Brace | 1 | 1/8" dia.x7" Formed Top Shock Strut | 1 | 1/8" dia.x13" Formed Bottom Shock Strut |
| 1 | 3/32" dia.x9" Formed Elevator Joiner | 1 | 1/16" dia.x3-7/8" Formed Front Door Lock | 1 | 1/16" dia.x4-7/8" Formed Rear Door Lock | 1 | 20' roll Soft Copper Wire |
| 9 | 10" long 2-56 Threaded Steel Rods | | | | | | |

| Hardware Bag | | | | | | | |
|--------------------------------|---|---|--|----|---|---|---|
| 3 | 1-72x1/2" Brass Bolts (Slotted Rd. Hd.) | 3 | 1-72 Brass Hex Nuts | 26 | #2x3/8" Sheet Metal Screws | 2 | #2x1/2" Sheet Metal Screws |
| 4 | 2-56x3/8" Bolts (Slotted Rd. Hd.) | 4 | 2-56x3/8" Bolts (Flat Head) | 11 | 2-56 Hex Nuts | 4 | 2-56 Blind Nuts |
| 6 | #2 Flat Metal Washers | 8 | 4-40x3/8" Bolts (Slotted Rd. Hd.) | 2 | 4-40x3/8" Bolts (Socket-Head) | 2 | 4-40 Hex Nuts |
| 10 | 4-40 Blind Nuts | 4 | 6-32x3/4" Bolts (Slotted Rd. Hd.) | 4 | 6-32 Blind Nuts | 2 | #6 Flat Metal Washers |
| 2 | 8-32x1/2" Bolts (Socket-Head) | 1 | 9/64" Allen "L" Wrench: for 8-32 bolts | 2 | 8-32 Blind Nuts | 2 | #8 Flat Metal Washers |
| 2 | 5/32" id Wheel Collars | 2 | 6-32x1/8" Headless Set Screws: for wheel collars | 1 | 1/16" Allen "L" Wrench: for wheel collars | 2 | 4-40x3/8" Nylon Bolts (Socket-Head) |
| 2 | Small Nylon Control Horns | 1 | Medium Nylon Control Horn | 4 | Nylon Landing Gear Straps | 3 | 2-56 Nylon R/C Links: Ailerons (2), Elevator(1) |
| 6 | 2-56 Metal R/C Links: Rudder (2), Tail Brace Wires(4) | 7 | 2-56 Solder Links: Elevator(1), Ailerons(2), Tail Brace Wires(4) | 2 | brass Pushrod Connector Bodies | 2 | 4-40x1/8" Socket-Head Bolt: set screw for pushrod connector |
| 4 | 1/4" od Nylon Retainers: pushrod connectors(2), door latch(2) | | | | | | |
| Easy Hinge Bag | | | | | | | |
| 17 | 3/4"x1" SIG Easy Hinges | | | | | | |
| Nylon Hinge Bag | | | | | | | |
| 2 | Molded Nylon Hinges | 4 | Straight Pins | | | | |
| Rudder Pull-Pull Bag | | | | | | | |
| 1 | .021" dia.x6 ft. Steel Cable | 4 | 3/32" odx1/2" Aluminum Tubes | 2 | 2-56 Rigging Couplers | 2 | 2-56 Hex Nuts |
| 1 | 1/8" dia.x2" Heat-Shrink Tubing | | | | | | |
| Tail Wheel Assembly Bag | | | | | | | |
| 1 | 3/32" id Wheel Collar | 1 | 4-40x3/16" Mounting Bolt (Slotted Rd. Hd.) | 2 | 4-40x3/8" Mounting Bolts (Slotted Rd. Hd.) | 2 | 4-40 Lock Nuts |
| 2 | 6-32x1/2" Mounting Bolts (Slotted Rd. Hd.) | 2 | 6-32 Square Anchor Nuts | 1 | Nylon Tailwheel Bearing | 1 | Nylon Rudder Horn |
| 1 | Nylon Tiller Bar | 1 | Formed Leaf-Spring | 1 | Formed Tailwheel Wire | 2 | Steering Springs |
| Miscellaneous | | | | | | | |
| 2 | Glass-Filled Engine Mounts | 2 | .130" od x36" Nylon Tubes: Elevator Pusrod, Throttle Pushrod | 1 | .190" od x36" Nylon Tube: Elevator Pushrod Sleeve | 1 | 1/16" od x24" Steel Cable: Throttle Pushrod |
| 1 | Aluminum Fueler Mount | 2 | .060" thick Aluminum: Lower Strut Fittings | 6 | .060" thick Aluminum: Upper Strut Fittings, Fuselage Strut Fittings | 1 | 7/8" od x17-1/2" Aluminum Wing Joiner Tube |
| 1 | .880 id x17-1/2" Phenolic Wing Joiner Tube | 3 | 5/32" od x12" Brass Tube for Jury Struts | 1 | 2"x20" Glass Cloth Tape | 1 | SIGDKM282A J-3 Cub Wing Decal |
| 1 | SIGDKM282B J-3 Cub Fuselage Decal | 1 | SIGDKM282C J-3 Cub Bear Decal | 1 | SIGDKM283A Clipped Wing Cub Fuselage Decal | 1 | SIGDKM283B Clipped Wing Cub Bear Decal |
| 1 | Printed Instrument Panel | 1 | Plan Sheet 1 | 1 | Plan Sheet 2 | 1 | Plan Sheet 3 |
| 1 | Plan Sheet 4 | 1 | Assembly Manual | | | | |

Wood Parts Identification

Dimensioned balsa and hardwood parts are easily identifiable by comparing their shape and dimensions to the plans and to the COMPLETE KIT PARTS LIST. On the other hand, proper identification of the different wing ribs, wing sheeting, fuselage formers, etc., can be confusing because some of them are very similar looking, when in fact they are quite different.

Use the following KEY TO LASER-CUT PARTS diagrams to correctly identify each part. Use a pencil to label each part with its name or number, before removing the parts from the laser-cut sheets.

IMPORTANT:

The laser cut parts contained in this kit are extremely accurate in outline and fit. They are meant to be used directly out of their sheets, without any trimming or sanding unless specifically called for in the instructions. The laser cutting process produces a brownish edge to the parts and, in some cases, a blackout edge may result when cutting harder plywood parts.

CA adhesives work perfectly on these parts and they do not need to be sanded to remove the discolored edges. In fact, sanding the edges of laser cut parts can change their shape and/or dimensions, resulting in a poor fit. DO NOT edge sand the laser cut parts in this kit.

Sheet 15 3/32" Plywood

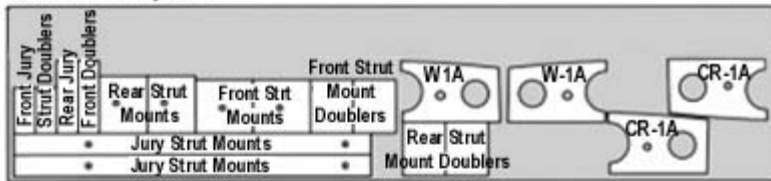

Sheet 1 1/8" Lite-Ply

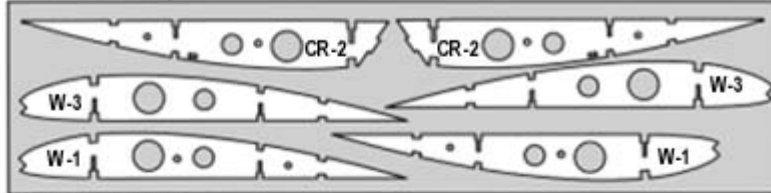

Sheet 27 1/8" Lite-Ply

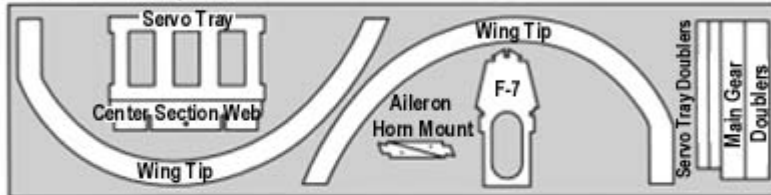

Sheet 8 3/32" Balsa

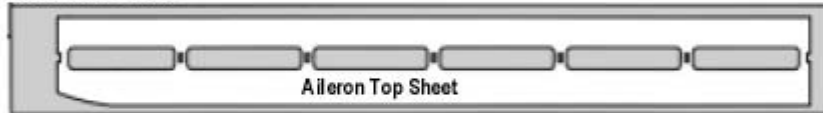

Sheet 9 3/32" Balsa

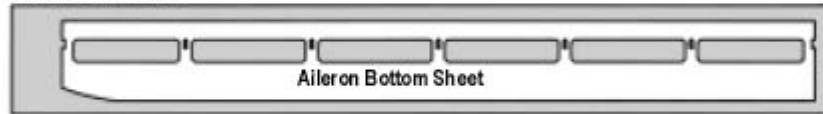

Sheet 20 3/32" Balsa

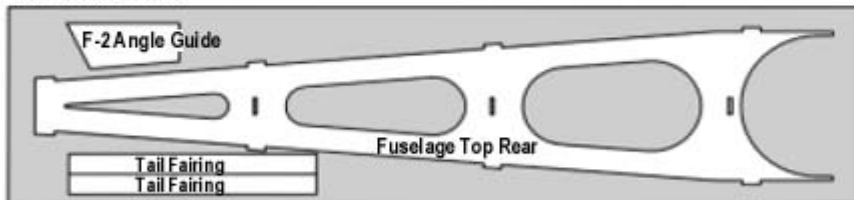

Sheet 21 1/8" Lite-Ply

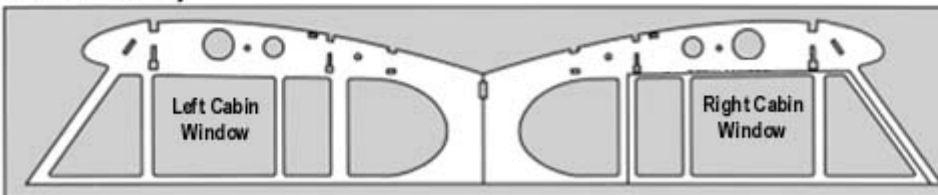

Sheet 2 1/8" Lite-Ply

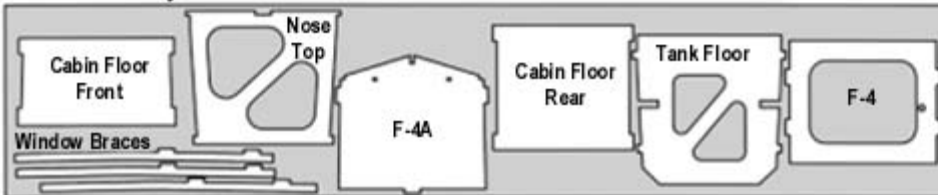

Sheet 26 1/8" Lite-Ply

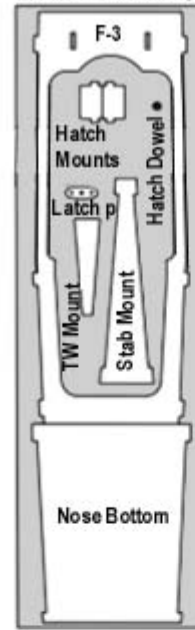

Sheet 22 1/4" Plywood

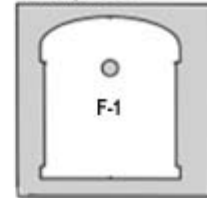

Sheet 7 1/16" Plywood



Sheet 18 3/32" Balsa

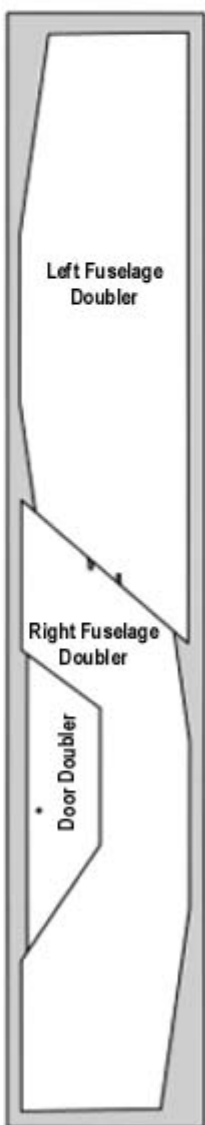

KEY TO LASER-CUT PARTS

Sheet 4 3/32" Balsa



Left Fuselage Doubler

Right Fuselage Doubler

Door Doubler

Sheet 3
3/32" Balsa

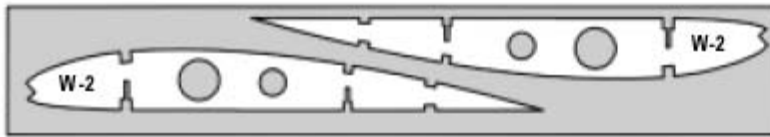

Sheet 10 3/32" Balsa

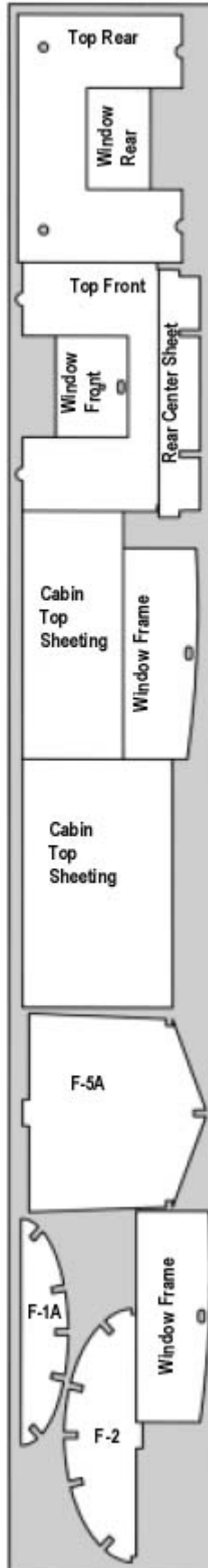

Sheet 24 3/32" Balsa

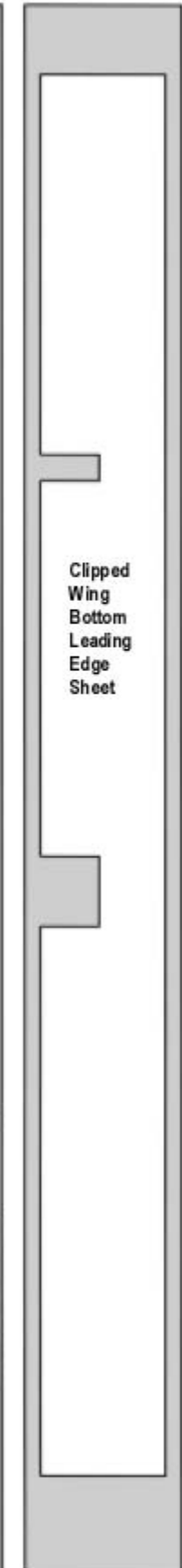

Sheet 23
3/32" Balsa

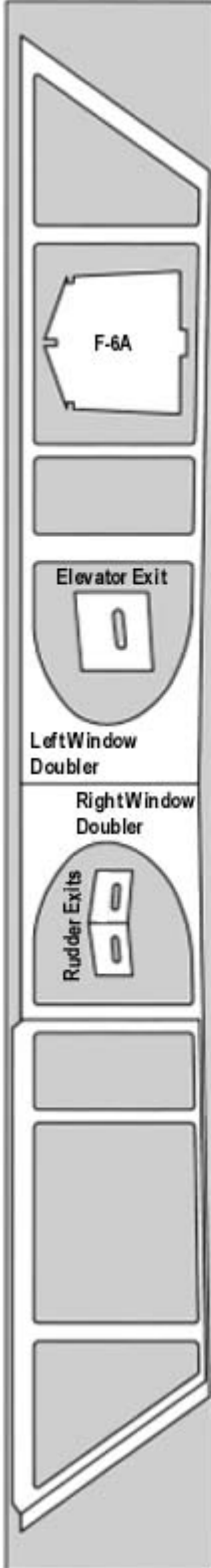

Sheet 16
1/8" Balsa

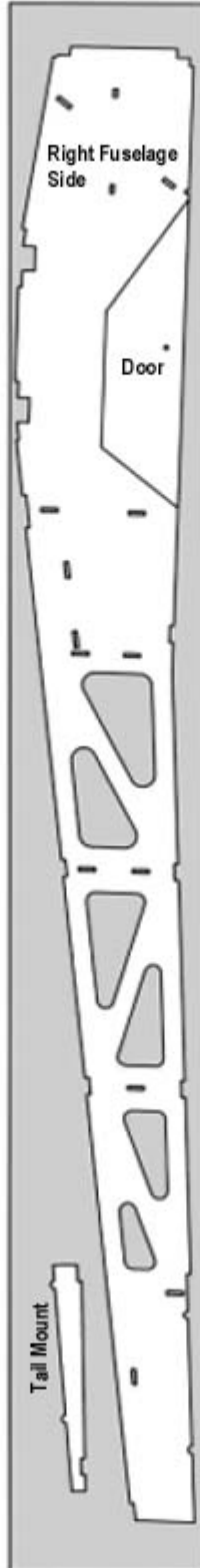

Sheet 17
1/8" Balsa

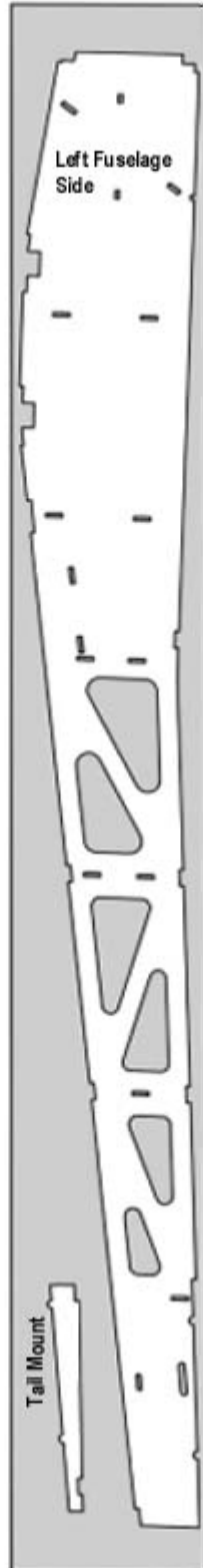

KEY TO LASER-CUT PARTS

Sheet 19
3/32" Balsa

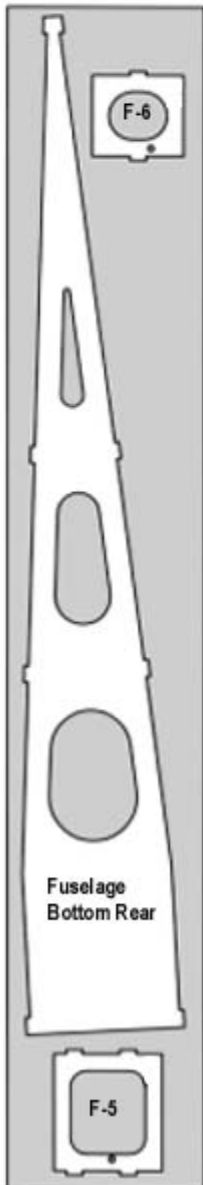

Sheet 11
3/32" Balsa

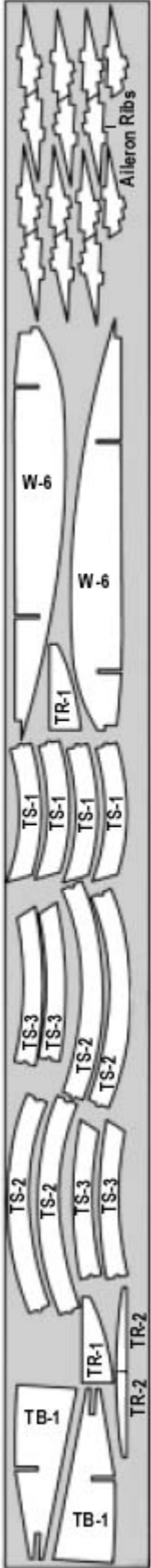

Sheet 13
5/16" Balsa

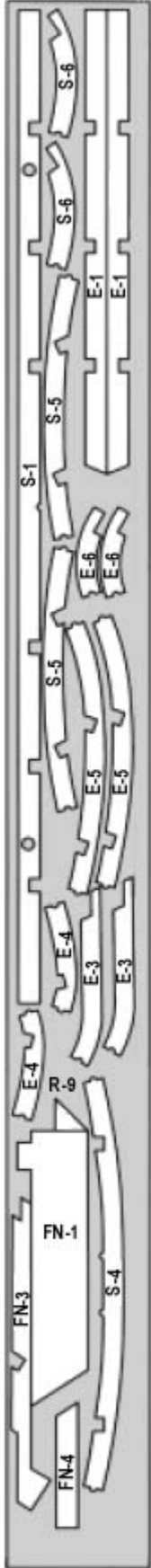

Sheet 5
3/32" Balsa



Sheet 12
3/32" Balsa



Sheet 25
3/32" Balsa

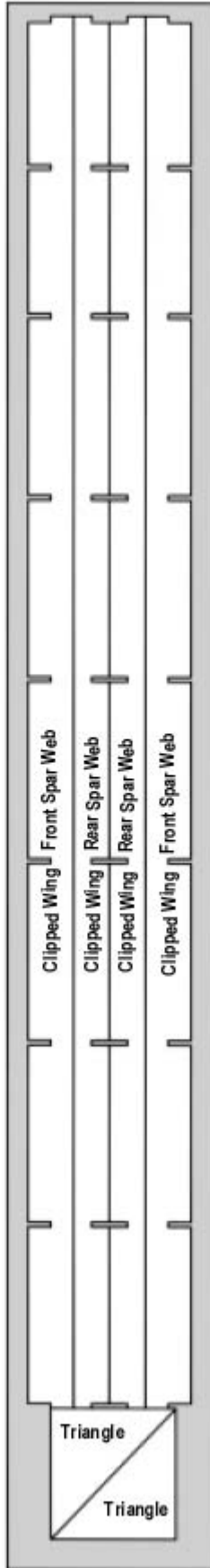

Sheet 6
3/32" Balsa

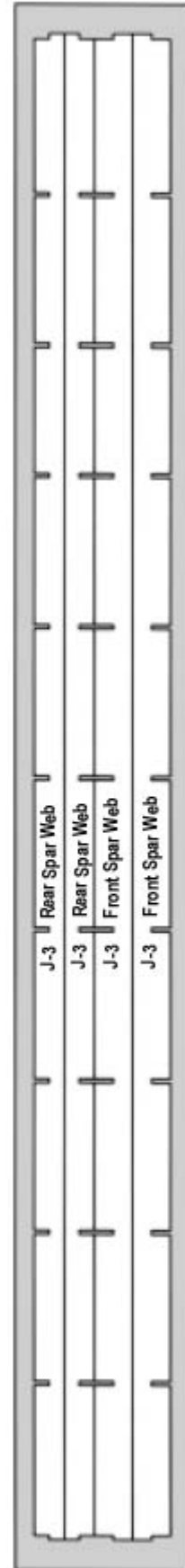

Sheet 14
5/16" Balsa

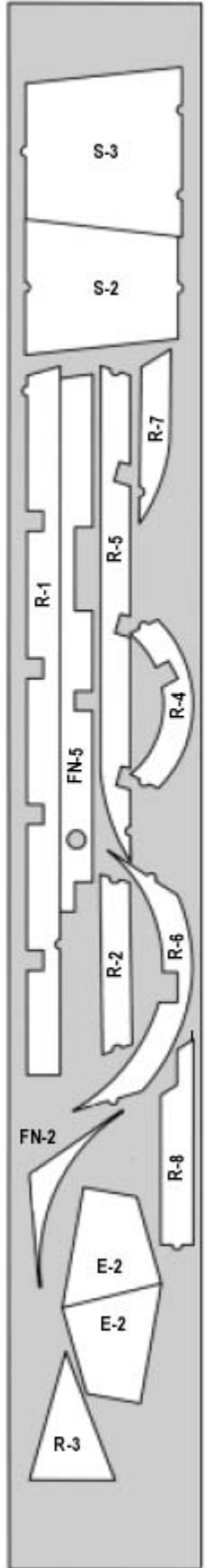

FULL-SCALE CUB PHOTO ALBUM



Les Gaskill's PIPER J-3 CUB



FUSELAGE CONSTRUCTION

Fuselage Sub-Assemblies

- 1a. Mark the vertical centerline and thrust line on the F-1 firewall using the plan cross-section and tick marks on the firewall.
- b. Check the width of your engine and determine the spacing needed between the motor mounts. Using the lines on the firewall, locate the mounts and mark the location of the four mounting holes on the firewall. Drill a 11/64" hole at each mark.
- c. Bolt the engine mounts loosely to the firewall with four 6-32 x3/4" bolts and 6-32 blind nuts. Double check the location and spacing of the mounts. Tighten the bolts until the prongs of the blind nuts are started in the wood and holding. Remove the motor mounts from the firewall and seat the blind nuts with a hammer.
- d. Lay former F-1A (sheet10) on the backside of the firewall. Mark and cut out around the top two blind nuts and glue it to the back of the firewall. Apply Thick CA or epoxy over the blind nuts to hold them in place. Do not get glue in the threads.

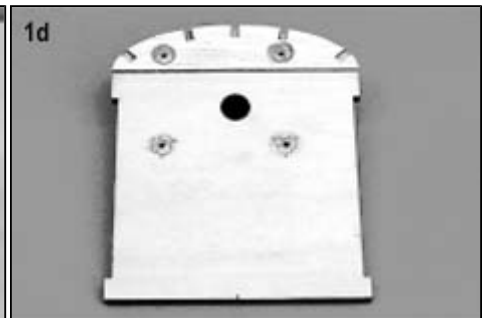
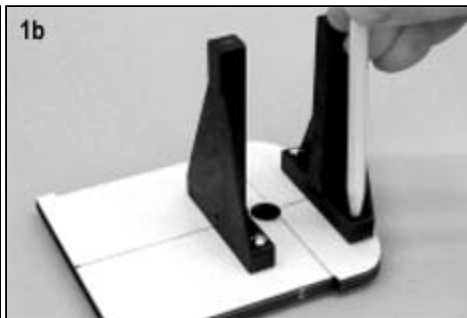
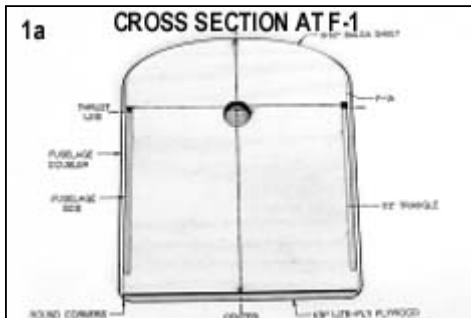

- 2a. Mount the engine mounts back onto the firewall. Using the side view plan as a guide, locate the engine on the mounts so the propeller will clear the front of the cowl by 1/8". Carefully mark the location of the engine mounting holes onto the mounts.



- b. Remove the engine mounts from the firewall for drilling of the clearance holes for your engine mounting bolts. It's best to lock the mount in a vise and drill the holes with a drill press, if you have access to one. Note: Because some .40-.46 engines use 4-40 mounting bolts and some use 6-32 bolts, we do not supply the bolts and lock nuts for mounting your engine to the mounts.

- c. Next, bolt the engine mounts back onto the firewall, and then the engine to the mounts. Assemble one of the supplied Pushrod Connector assemblies in the engine's throttle arm. Now determine the best location for the throttle pushrod to pass through the firewall and line up with the pushrod connector. (in the case of the Irvine .46 in the photo, that spot is right above the leg of the engine mount - your's may be a little different). Once determined, mark the location and drill a 9/64" dia. hole through the firewall for the pushrod.



- 3a. Glue the tailwheel mount (sheet.26) to the balsa fuselage bottom rear (sheet 19).

- b. Draw a center line on the fuselage bottom rear and mark the location of the mounting holes for the tailwheel leafspring. Drill the holes with a 5/32" bit. Mount the leafspring to the fuselage with the 6-32 x1/2" machine screws and square nuts provided.

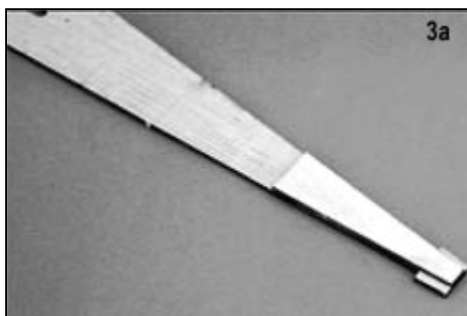

- c. Epoxy the square nuts firmly in place being careful not to get any glue on the machine screws. When dry, remove the leafspring.
4. Locate former F-5A (sheet 10) and former F-6A (sheet 23). Using the cross-sections on the plans as a guide, glue the 1/8"x1/4" balsa stiffeners to the back of the two formers.
5. Remove the right fuselage side and tail mount from sheet 16, and glue them together as shown. Do the same for the left fuselage side and tail mount, which are in sheet 17.
6. Remove the servo tray and the two servo tray doublers from sheet 27. Glue the doublers in place on the servo tray. Make sure that the end of the doubler does not stick out beyond the edge of the tray.

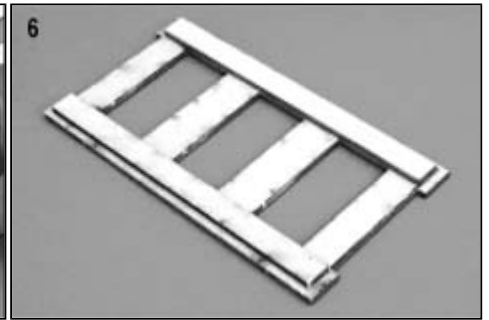
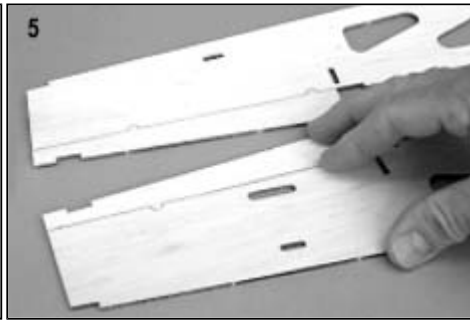
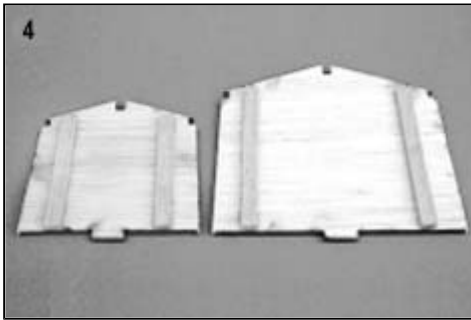

7. Now is a good time to mount your servos in the servo tray. Position the servos in the tray as shown and pre-drill the mounting holes.
8. Locate the three window braces (sheet 2). Compare the length of the three braces - two the same and one is different in length. The longer one is glued in the front notch on the left fuselage side at the front notch and the shorter one is glued in the back notch. The other short brace is glued in the rear notch of the right fuselage side. Be sure to glue these braces to the INSIDE of the fuselage sides.
9. Locate the two 3/8"x3/4"x4-15/16" grooved hardwood landing gear blocks and the two gear doublers (sheet 27). Glue one doubler to the top of each grooved block.

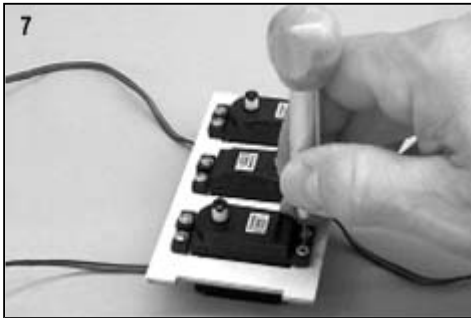

Basic Fuselage Assembly

- 10a. Match up fuselage formers F-4, F-5, and F-6 to their cross-section drawings on the plans, and then mark "top front" on these formers. This will help you keep the orientation of these formers correct when placing them in the fuselage during the next step, which will result in the holes for the elevator pushrod being in the correct location on the left side of the fuselage.

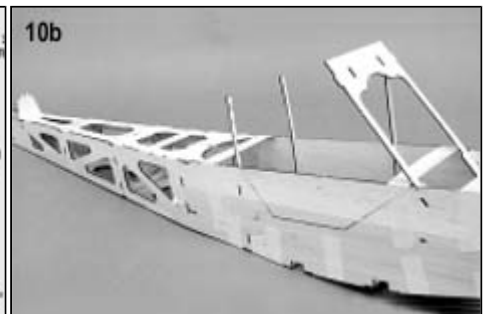
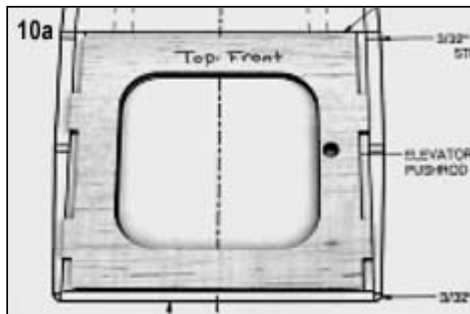

- b. Assemble fuselage formers F-1, F-3, F-4, F-5, F-6, F-7, the Servo Tray, and Tank Floor in place between the fuselage sides. Add the Fuselage Top Rear, Fuselage Bottom Rear, Cabin Floor Rear, Cabin Floor Front, Nose Top, and Stab Mount between the fuselage sides. Use masking tape at each former to help hold everything in place.
- c. Carefully eyeball the alignment of the fuselage. It should be very close to perfect, thanks to the accuracy of laser-cut parts. If there are any persistent twists, now is the time to figure out what's causing it and fix it. Once the fuselage is glued, it can't be realigned. Double check that the opening at the back end of the fuselage is square with the fuselage top. If necessary, gently twist or push the parts in the desired direction and use masking tape to hold them there.
11. When satisfied that everything is lined up properly, start gluing all the parts in place with Thin CA, working from the inside of the fuselage first. Start with small applications of glue in the corners, checking the fuselage alignment as you go. Keep applying glue until the complete inside of the fuselage has been gone over once. Now go back and glue all joints with MEDIUM CA. Leave the tape in place until all of the glue has dried.
Note: We do not recommend gluing the F-1 Firewall with CA glue. Use epoxy.
12. Once you've got the firewall glued in, cut two 4" long pieces of 1/2" balsa Triangle stock and glue in the corners behind the firewall, for reinforcement. Make sure to locate the triangles on the topside of the lite-ply Nose Bottom.
- 13a. Now is a good time to assemble your fuel tank and figure out how you're going to mount it in the fuselage. We recommend using blocks of scrap balsa or foam to block the tank in position. Note: If the recommended fuel tank is used (Du-Bro 12 oz.), you can do a trial installation now and then remove the tank for final installation after the airplane is covered.

- b. Remove the fuel tank and dry fit a .130" od nylon tube for the throttle pushrod through the hole in the firewall and back to the servo area. Slide the fuel tank back in position, then insert the 1/16" od steel cable inside the nylon tube and check for the movement. Correct any binding problems now, as it will be hard to get to this area later on.



14. Glue the Nose Top (sheet 2) in place on the fuselage. You will need to tuck it under the F-1A former and slide it up to the back of the firewall.

15. Cut the door loose from the Right Fuselage Side. Set it aside until needed later.



16. Locate the Right and Left Cabin Windows (sheet 21) and parts CR-1A (sheet 15). Glue a CR-1A on the inside (right side) of Left Cabin Window, and one on the inside (left side) of the Right Cabin Window.

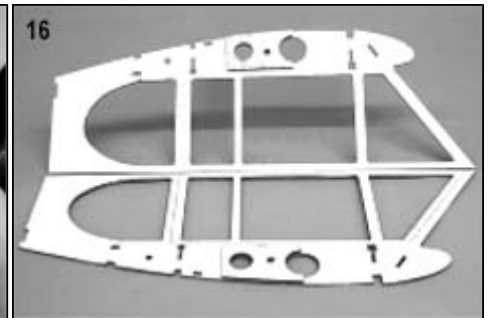

17. The following steps a, b, and c should be done without glue! The gluing will come in step d.

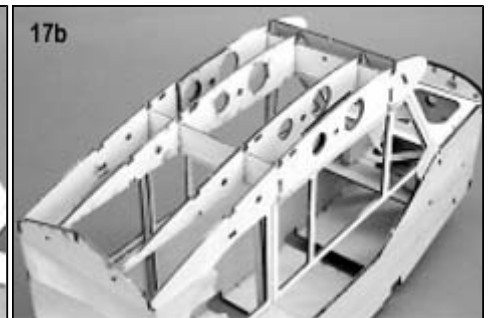
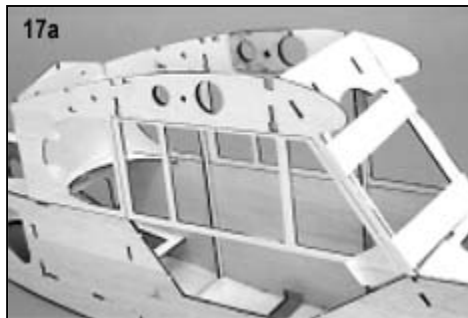

- a. Tape the Right and Left Cabin Windows securely to the sides of former F-3. Then tape former F-4A in place at the rear of the Cabin Windows.

- b. Cut two 5" long pieces of 1/4" sq. balsa and two 5" long pieces of 3/16" sq. balsa. Slide one of the 1/4" sq. pieces in the bottom front notches of the cabin windows, spanning from one cabin window to the other. Likewise, insert one of the 3/16" sq. pieces in the bottom rear notches cabin windows. Next, put the plywood Center-Section Web (sheet 27) in place on top of the 1/4" sq. Put the balsa Rear Center Web (sheet 10) in on top of the 3/16" sq. Now insert the two CR-2 ribs (sheet 1) in place over the front and rear webs and into formers F-3 and F-4A. You will need to untape F-3 and F-4A to do this - when done, tape all the parts securely back together.

- c. Put in the remaining 3/16" sq. and 1/4" sq. pieces in their respective notches. Also, cut two 5" long pieces of 1/8"x1/4" balsa, and insert them in the upper and lower notches in the rear of the ribs. Also, install the Hatch Mounts (sheet 26).
- d. Now, you can glue all the parts in the cabin area together with Thin CA. Be sure all the joints are tight when applying the glue. It's critical that the cabin windows are tight against former F-3, the spar webs, and the window braces, as this will set the dihedral angle in the wings. When everything is glued and dry, you can cut loose the right side window.

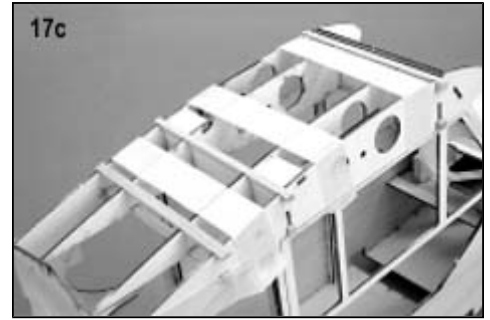

18 Carefully cut the "Door Window" portion of the Right Cabin Window loose. Set aside until needed later.

19a. Locate former F-2 (sheet 10) and the F-2 Angle Guide (sheet 20). Glue former F-2 in place on the nose top, using the angle guide to set the proper angle.

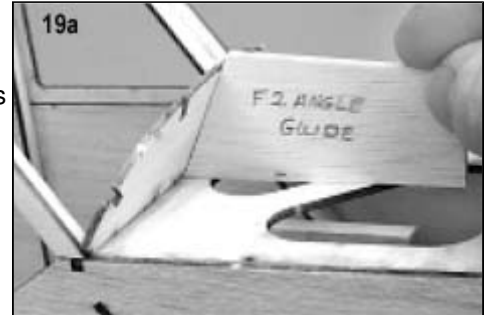

b. Cut five pieces of 1/8"x1/4" balsa stick to use as stringers to run between formers F-1A and F-2. It is best to glue in the center stringer first, using the F-2 angle guide to make sure former F-2 stays in proper alignment. Then glue in the other four stringers.

20a. Cut the Right Fuselage Doubler, Left Fuselage Doubler, and Door Doubler loose from laser-cut balsa sheet 18. Set these parts aside for a moment.

b. Before you can glue the Fuselage Doublers onto the outside of the fuselage, you need to sand flush any former "tabs" that may be sticking out beyond the fuselage sides.

c. Now, glue the Left and Right Fuselage Doublers in place on the fuselage.

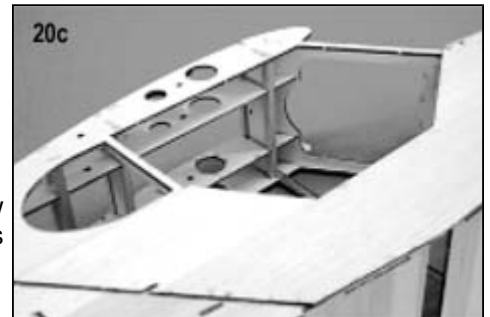

21a. Carefully cut the Right Window Doubler, Left Window Doubler, and Door Window Doubler loose from laser-cut balsa sheet 23. Handle these parts very carefully as they are easy to break at this point.

b. Glue the Left and Right Window Doublers in place on the fuselage.

22a. Retrieve the Door that you cut loose from the Right Fuselage Side back in step 15, and the Door Doubler from step 20. Glue these two parts together, making sure they are flush along their bottom edges.

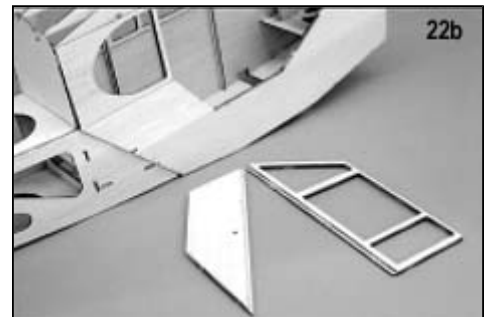

b. Retrieve the Door Window that you cut loose from the Right Cabin Window back in step 18, and the Door Window Doubler from step 21. Glue these two parts together, making sure they are flush along their top edges.

23. Cut two 3/32"x3"x4-1/2" pieces of balsa from one of the 36" long sheets provided. These are for sheeting over the top of the nose from F-1 to F-2. Once you have the sheets cut, glue them on edge against the top edges of the fuselage doublers. Let dry. Then bend the sheets over the top, gluing them to the stringers and formers. Trim the two sheets where they meet over the center stringer.



When dry, sand the ends of the sheeting flush with the front of the F-1 firewall and flush with the back of F-2. Builder's Tip: If you having difficulty bending the balsa sheeting without splitting, dampen the outer surface of the balsa with water or alcohol to make it bend easier.

Removable Cabin Hatch

The top portion of the fuselage cabin sheeting (the area between the 3/16" sq. and 1/4" sq. balsa pieces that were installed in step 17b.) will be removable so that you will have easy top access to the wing mounting hardware.

24. Locate the two Cabin Top Sheeting pieces (sheet 10). The wider of the two should be permanently glued to the top of the CR-2 ribs and up against the front of former F-4A. Then, glue the narrower sheet onto the ribs right in front of the first sheet. When dry, sand the the edges of the balsa sheets flush with the plywood cabin windows.

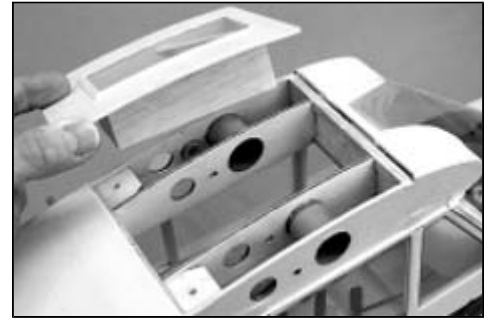

- 25a. Locate the Top Front and Top Rear pieces for the cabin hatch sheeting (sheet 10). Glue the two pieces together along their interlocking edges.

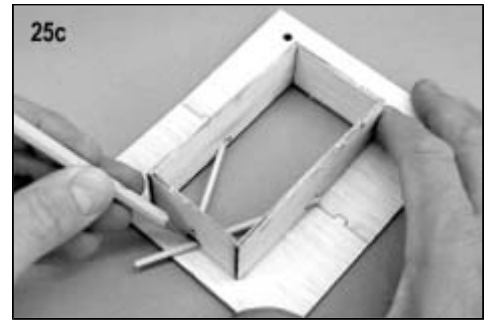

- b. Locate the Window Front, Window Rear, and two Window Frame pieces (sheet 10). Glue these four pieces onto the cabin hatch sheeting, lining them up along the edges of the window opening. These pieces form the window frame.

- c. Scale-like window bracing is made out of a 1/8"x6" hardwood dowel. Cut the dowel in half and install the two halves into the slots in the side Window Frames and the Window Front. Mark and cut off the dowels flush with the outer surfaces of the window frame.

26. Glue the two Cabin Hatch Hardpoints in place on the bottom of the hatch sheeting, centered over the holes that are already there.

27. Cut a 1/2" long piece of 1/8" dowel and glue it in the hole in the front of the window frame, leaving about 3/8" of dowel sticking out the front. Now slide the 1/8" plywood Hatch Dowel Support (sheet 26) over the dowel and up against the window frame, then glue it in place.

Builder's Tip:
Use the 4-40 x3/8" socket-head Nylon Bolts to keep the hardpoints lined up with the holes in the sheeting while you are gluing the hardpoints in place. Don't get any glue on the bolts.



- 28a. Trail fit the hatch on the fuselage, inserting the dowel at the front into the hole in the plywood Center-Section Web. NOTE: You may have to sand a small amount off the back of the hatch sheeting to make it fit flush with the sheeting that is on the fuselage. Also, allow a little extra room for the thickness of the covering material that you are going to use.



- b. When satisfied with the fit, tape the hatch in place and mark the holes for the mounting bolts (4-40 x3/8" socket-head) onto the Hatch Mounts in the fuselage. Drill the holes with a 9/64" bit and glue 4-40 blind nuts in the bottom of the Hatch Mounts.

Completing The Fuselage

- 29a. Slide one end of the Phenolic Tube into one side of the cabin center section. Push it in until the end is flush with the inside of nearest CR-2 rib. Mark the tube to be cut off flush with the outside of the cabin. Use a razor saw to cut the tube at the mark. Repeat the process to cut another phenolic tube for the other side of the cabin. Note: Be sure you are cutting the Phenolic not the Aluminum Tube!



- b. Glue the phenolic tubes in place in the holes. When dry, sand the outside ends of the tubes flush with the window frame.

30a. Glue the two hardwood Landing Gear Blocks into the bottom of the fuselage.

b. Cut 2 pieces of 1/2" balsa triangle stock to 4-11/16" long. Glue them in place in the fuselage at the front and rear of the front Landing Gear Block, to reinforce it to the bottom of the fuselage.

c. Cut another piece of 1/2" balsa triangle stock to 4-9/16" long and glue it in at the back of the rear Landing Gear Block.

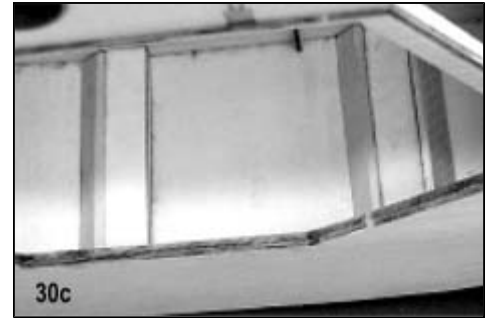

31a. Glue formers F-5A (sheet 10) and F-6A (sheet #23) in place on the top of the fuselage. Make sure you glue F-5A and F-6A in parallel with the formers F-5 and F-6 formers below them, NOT perpendicular to the top sheet.

b. Locate the 1/8"x1/4"x24" spruce Top Stringer. Using the side view plan as your guide, taper the front of the Top Stringer to fit on top of the cabin sheeting. Then, glue the Top Stringer in place.

c. The fuselage Top Corner Stringers are 1/8"x1/4"x48" balsa. Measure and cut them to length, and then glue them in the notches of the formers.

d. Sand all stringers flush with the rear face of former F-7.

32a. Glue the Elevator Exit Guide (sheet 23) in place on the left side of the fuselage. Be sure to line up the slots carefully.

b. Glue the Rudder Exit Guides (sheet 23) in place on each side of the fuselage. Again, Be sure to line up the slots carefully.

33a. Locate one of the .130" od x36" Nylon Tubes provided. Cut two 4" long pieces off one end of the tube (save the remainder for the Throttle Pushrod). These 4" tubes will be installed in the fuselage as guides for the rudder pull-pull cables. Use a heat gun to soften the tube enough to allow you to bend a slight radius in it, as shown in the picture. Hold until the tube cools.

b. Slide the tubes in the slots of the Rudder Exit Guides and check the radius of the bend. The bend is to allow the tubes to have a straight shot to the rudder servo area in the forward part of the fuselage. If necessary, re-heat the tubes and correct the bend. Then, glue the tubes in place in the Rudder Exit Guides. They should stick out past the F-7 former 3/8".

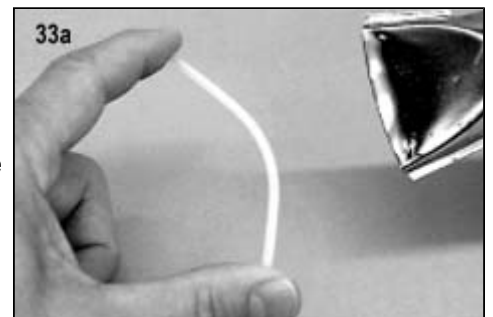

34a. Locate the .190" od x36" Nylon Tube provided for the Elevator Pushrod Sleeve. Starting at the rear Elevator Exit Guide, slide the tube into the fuselage, guiding it into the formers. Leave 1/4" of tube sticking out past the front of F-4 former.

b. Locate the .130" od x36" Nylon Tube provided for the Elevator Pushrod. Slide the tube inside the Elevator Pushrod Sleeve. It should slide all the way in easily without any binding. If there is binding, now is the time to pinpoint the cause and fix it.

c. Glue the outer Elevator Pushrod Sleeve to the Elevator Exit Guide with CA glue. Then, glue the sleeve securely to each former.

d. Use a single-edge razor blade to trim the outer elevator pushrod sleeve and the rudder exit tubes flush with the outside of the fuselage.

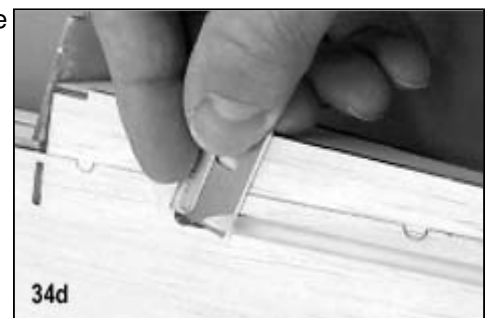

35. Glue two 3/32"x1/4" balsa Side Stringers in place on each side of the fuselage. Study the plan side view and the cross section drawings to determine exactly where the Side Stringers should be located. The upper Side Stringer is glued along the entire top edge of the main frame, starting at the doubler in the front, and going all the way to the tail end of the fuselage.

The lower Side Stringer goes in a straight line from the notch in the doubler, back to the tail end of the fuselage.

36. Cut the two 3/32"x3/32"x36" balsa sticks provided to 32" long for the bottom Corner Stringers (save the remainder for the wing). Glue one stringer on each side of the fuselage right along the bottom edge.
37. Glue the two pieces of 3/32"x1/2" scrap balsa just ahead of former F-7.
- 38a. Sand the front of the Side Stringers flush with the fuselage doublers.
- b. Taper the rear of the Side and Corner Stringers from full width at former F-7 down to nothing at the rudder post.

Builder's Tip:
Crooked stringers look bad! It's best to hold a straight edge alongside the stringer as you tack glue it to the fuselage. Then, remove the straight edge and finish gluing the entire stringer in place.

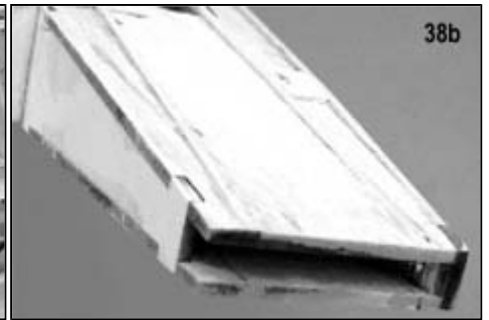
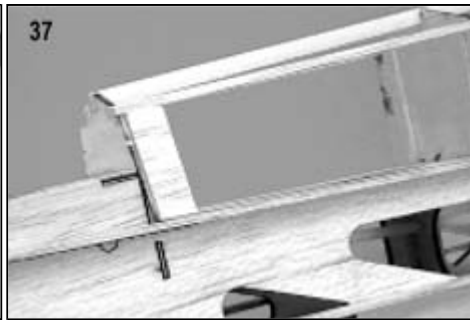

39. The fuselage is now ready for final sanding. Use a sanding block with 80 grit paper to sand smooth all the exterior glue joints. Block sand the exterior corners using the cross-sections on the plans as a guide. After sanding with the block, go over the entire fuselage with hand-held 220 grit paper.
40. Two 1/8" od x 6" hardwood dowels are provided to simulate the diagonal cross braces that run from the corners of the instrument panel up to the center of the wing spar on a full-scale Piper J-3 Cub. Cut the dowels to length, bevel the ends to fit, and then glue them in place. Refer to the front view plan.



Door And Window Latch

- 41a. Locate the .130" od x28" nylon tube left over from step 32. Cut a 1/4" piece off one end and glue that piece in the hole in the door. Make sure it is flush with the outside of the door.
- b. Locate a 2-56 x10" threaded rod. Cut the rod to 1-3/4" long, including the threaded end. Slide the plain end of the rod thru the nylon tube that you glued in the door. Slide it thru until the threads are right up against the nylon tube. Then, on the other side of the door, mark the plain end of the rod flush with the side of the door.

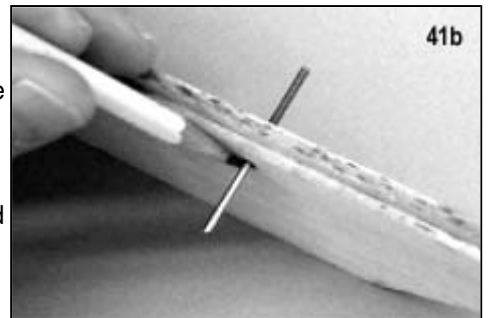

42. Remove the rod from the door and solder a #2 flat metal washer to the rod at the mark. **Builder's Tip:** The best way to do this is to slide a short piece of heat-proof silicone fuel tubing over the wire to hold the washer in place on the wire and to prevent the solder from seeping onto the other side of the washer.

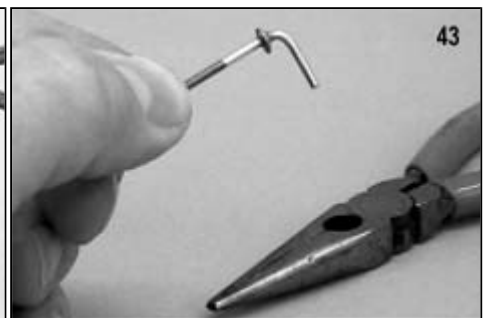
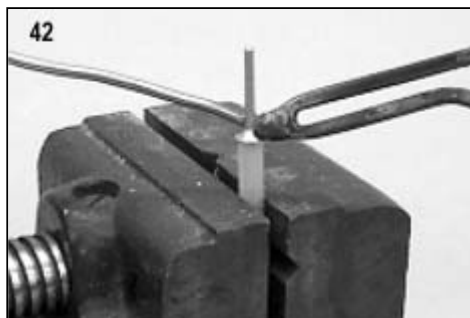

43. After the wire cools, bend the unthreaded part of the wire 90 degrees to form a handle.

44. Screw the threaded end of the wire into the nylon tube from the outside of the door. Screw it in until the threaded portion goes completely thru the tube and the soldered washer is up against the outside of the door. Now place another #2 flat metal washer on the opposite side of the door and screw on a 2-56 hex nut.

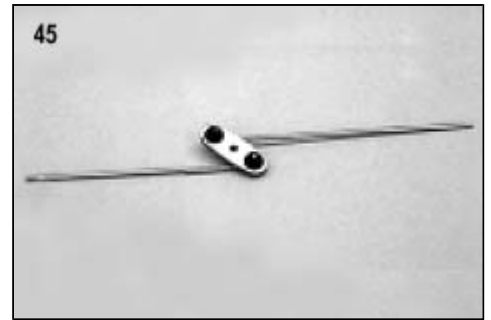

45. Locate the plywood Latch Pivot (sheet 26), the formed Front Door Lock and Rear Door Lock wires, and two 1/4" od black Nylon Retainers. Install the bent ends of the two wires in the outer holes of the Latch Pivot. Use a pair of pliers to press on the Nylon Retainers.

46a. Mount the latch assembly to the door handle with another #2 flat metal washer and 2-56 hex nut. (Pay attention to the length of the two wires - the longer one goes to the back of the door and the shorter one goes to the front.)



b. Cut two 1/2" long pieces of the .130" od nylon tube. Slide these tubes over the lock wires and turn the latch in the lock position (wires out). Position the nylon tubes near the edges of the door, as shown on the side view plan. Tack glue the nylon tubes in place on the door.

47. Locate the two Molded Nylon Hinges and four Straight Pins. Cut the two hinges in half to make four hinges. Assemble the four hinges with the pins, as shown. Cut the excess length of the pins off with a sharp side-cutting pliers.

48. Hinge the Door to the fuselage with two of the hinge assemblies from the previous step. Refer to the side view plan for the exact hinge locations. Note that the hinge slots should be cut in the outer 3/32" balsa doublers - don't try to cut them in the glue line. You will also need to countersink the knuckle of the hinge into the bottom edge of the door, so that you don't end up with a big hinge gap.

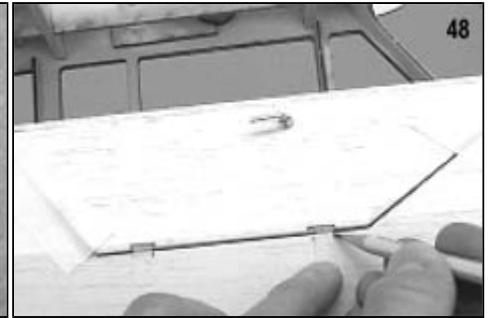

DO NOT glue the hinges in the wood at this time - wait until after covering.

49. Cut one 1/2" long piece and one 1/4" long piece of the .130" od nylon tube. With the door hinged on the fuselage, and the latch in the lock position (wires out), slide the 1/2" tube over the front lock wire and then tack glue it to the inside wall of the fuselage. Slide the 1/4" over the rear lock wire and tack it in place. Double check that the latch works successfully. Then, go back and reglue the four nylon tubes with a bead of Medium CA. Be careful not to get any glue inside the tubes.

50a. Hinge the Door Window to the fuselage in the same manner you did the door in step 46. Note that the hinge slots in the Door Window should be cut between the plywood and the balsa. Countersink the knuckle of the hinges into the top edge of the window, so that you don't end up with a big hinge gap. You will also need to cut a little more off the width of the rear hinge in order for it to match the width of the rear post. DO NOT glue the hinges into the Door Window at this time - wait until after covering.

b. For the top half of the Door Window hinges, simply cut a notch thru the balsa window doubler on the fuselage, so that the top half of the hinge will lay flat on the plywood rib. Go ahead and glue the top of the hinges to the plywood rib at this time. You want them to be covered over with the covering material later.

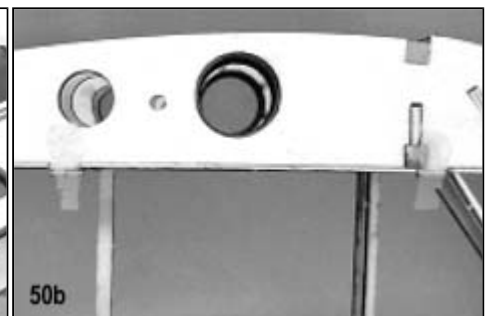
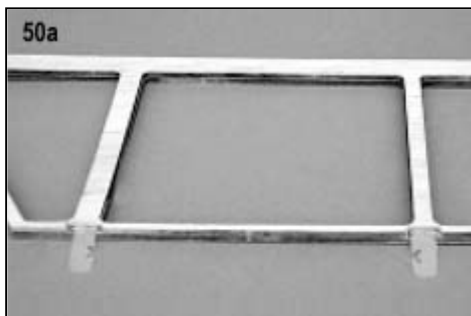

Stabilizer And Elevator

60a. Tape or pin the stabilizer/elevator plan down on a flat building board. Cover with wax paper or plastic wrap. Locate parts S-1, S-4, S-5, S-6 (sheet 13), and parts S-2, S-3 (sheet 14). Glue and pin these parts together over the plan.

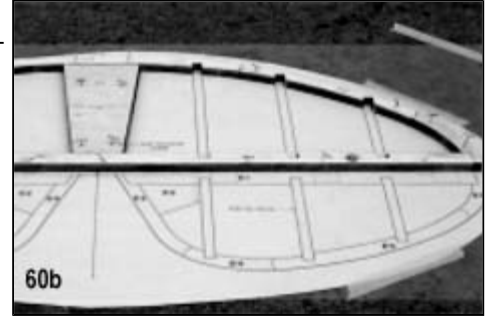

b. Hardpoints need to be installed in the stabilizer trailing edge S-1 for the mounting of the tail brace wires later. A 5/16" od x1-1/2" dowel, with a 5/64" id hole thru the center, is provided for making these hardpoints. Trial fit the dowel in the two holes in S-1. You may need to sand the outer surface of the dowel slightly to get a good slide fit. Cut two 5/16" long pieces of dowel and glue them into the holes in S-1.

61. Cut six 5/16" sq. balsa stabilizer ribs from the 36" stock provided. Glue the ribs in place with Thin CA.

62a. When the glue is dry, remove the stabilizer frame from the board and re-glue all the joints with Medium CA. Use enough glue to completely fill the joints, plus leave a small fillet of glue between the parts. Take your time and don't miss any joints! Each one of them contributes to the finished strength of the stabilizer.

b. Lay the stabilizer back on the board and lightly sand both sides to smooth out all the glue joints.
CAUTION: Do not sand so much that you thin down the stabilizer more than 1/32" under its original 5/16" thickness.

c. Mark a center-line all the way around the edges of the stabilizer. Using the center-line as a guide, sand the edges round.

63a. Locate parts E-1, E-3, E-4, E-5, E-6 (sheet 13), and part E-2 (sheet 14). Glue and pin these parts together over the plan.

b. Cut to length and glue in the 5/16" sq. balsa ribs for the two elevator halves.

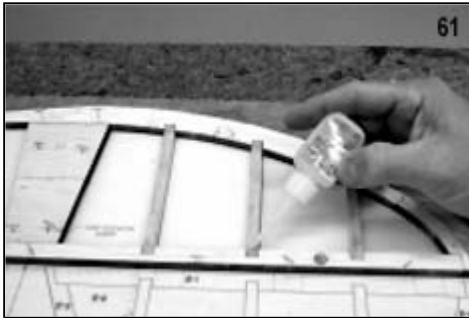

64a. When the glue is dry, remove the elevators from the board and re-glue all the joints with Medium CA. Use enough glue to completely fill the joints, plus leave a small fillet of glue between the parts.

b. Lay the elevators back on the board and lightly sand both sides to smooth out all the glue joints.
CAUTION: Do not sand so much that you thin down the stabilizer more than 1/32" under its original 5/16" thickness.

65a. A 3/32" dia. formed Elevator Joiner Wire is used to join the two elevator halves into a single unit. The Elevator Joiner Wire must be inlet into the leading edge of the elevators and then epoxied in place.

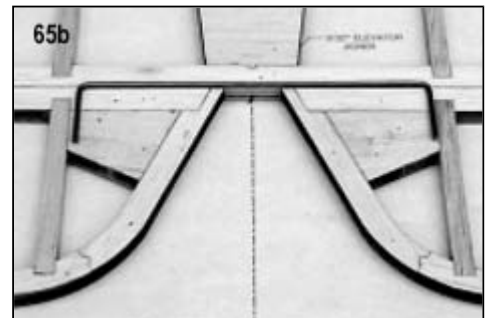

b. The first step is to clean the Joiner Wire with paint thinner or acetone to remove any oil or grease. Then, match up the elevators and stabilizer on the plan. Now, place the Elevator Joiner Wire in position on top of the elevators and mark the locations where the legs of the wire will go back into the leading edges of the elevators. Carefully drill a 3/32" dia. hole at both locations. To best control the centering of these holes, we suggest using a non-powered twist drill bit in a pin vise. Make each hole 1-1/2" deep and 90 deg. to the leading edge.

c. Groove the leading edge of the elevator to accept the shank of the Joiner Wire, from the hole you drilled all the way out the inboard end of the elevator. This is easiest to do using a hobby knife with a #11 blade.

d. Trial fit the elevators together on the wire joiner. Adjust the grooves and holes as required to achieve a good fit. Then, mix up a small batch of 5-minute epoxy and apply glue into both holes and the grooves in elevator halves. Install the Joiner Wire into each elevator half and wipe off any excess epoxy. Lay this assembly onto wax paper on the plans, with the leading edge firmly against a straight edge, and then pin in place.

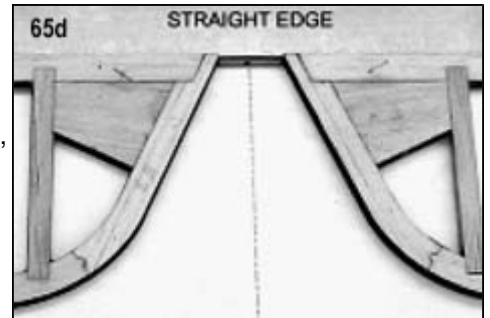

66. Mark a center-line all the way around the leading and trailing edges of the elevators. Using the center-line as a guide, sand the edges round.

67. Cut two 1" long pieces of Glass Cloth Tape from the 2"x20" piece provided. Hold the pieces one at a time with a tweezers while you lightly spray one side with 3M-77 spray glue. Wrap the piece around the leading edge of the elevator, over the joiner wire installation, for reinforcement. Smooth out any wrinkles. Then, flow a coat of Thin CA glue into the tape. Wipe off any excess and let dry. Lightly sand with 220 grit sandpaper.

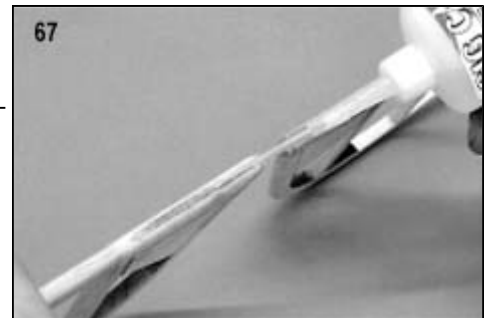

Fin And Rudder

68a. Tape or pin the fin/rudder plan down on a flat building board. Cover with wax paper or plastic wrap. Locate parts FN-1, FN-3, FN-4 (sheet 13), and parts FN-2, FN-5 (sheet 14) . Glue and pin these parts together over the plan.



b. A hardpoint needs to be installed in the fin trailing edge FN-5 for the mounting of the tail brace wires later. A 5/16" od dowel, with a 5/64" id hole thru the center, is provided for making the hardpoint. Cut a 5/16" long piece off the dowel and glue it into the hole in FN-5.

c. Cut a 5/16" sq. balsa stick for the fin rib and glue it in place.

69a. Locate parts R-1, R-2, R-3, R-4, R-5, R-6, R-7, R-8 (sheet 14), and R-9 (sheet 13). Glue and pin these parts together over the plan.

b. Cut to length and glue in the 5/16" sq. balsa ribs for the rudder.

70a. When dry remove the Fin and Rudder from the building board and re-glue all the joints with Medium CA.

b. Block sand both sides of the Fin and Rudder smooth.

c. Draw a center-line on the leading edge and trailing edges of the Fin and Rudder and sand them round. Do not sand the bottom edge of FN-1, so it can be glued to the stabilizer in a later step.

71. Lay the rudder back on the plan and mark the location of the Nylon Rudder Horn. With a #11 blade, inlet the leading edge of the Rudder to accept the Rudder Horn. Do not glue the Rudder Horn in place yet - it will be glued on after the rudder is covered.



WING CONSTRUCTION

As mentioned in the introduction, you can build either a standard PIPER J-3 CUB (84-1/2" wingspan) or a CLIPPED WING CUB (68-1/4" wingspan) from this kit. All of the parts to build either version are included. The differences between the J-3 and the CLIPPED WING are the wing panel length, the wing strut length, and the jury strut patterns. These differences are clearly shown on the full-size plans. Just make sure you are using the correct plans for the airplane you decide to build.

To build a PIPER J-3 CUB wing:

- The basic Wing Plan is on plan sheet 2
- The Wing Struts are on plan sheet 3
- The Jury Struts are on plan sheet 3

To build a CLIPPED WING CUB wing:

- The basic Wing Plan is on plan sheet 4
- The Wing Struts are on plan sheet 4
- The Jury Struts are on plan sheet 3

If you are using the correct plan, the only differences will be in the length of some of the parts. These parts will be cut from the same stock for either version. The differences in length will be noted in the instruction steps. However, note that ALL the photos are of the J3 wing.

72. Locate the two plywood W-1 wing ribs (sheet 1). When you punch out the circles in the W-1 ribs, don't throw the circles away! Cut two 7-3/8" long pieces of the .880" id Phenolic Tube Wing Joiner Sleeve material. Carefully glue one of the plywood circles, that you removed from the W-1 ribs, onto one end of each of the phenolic tubes. Lightly sand the outer edges of the plywood circle flush with the tube. Set the tubes aside until needed later.

NOTE: If you are building the Clipped Wing Cub, the phenolic tubes should be cut 5-3/4" long.



- 73a. Locate the two plywood W-1A ribs, (sheet 15). Glue one W-1A to each of the W-1 ribs. Be sure to make a left and a right rib assembly by gluing the W-1A ribs on opposite sides of the W-1 ribs! Match up the cutouts in the ribs carefully when gluing them in place (the photo shows the phenolic tube being used to help align the holes).

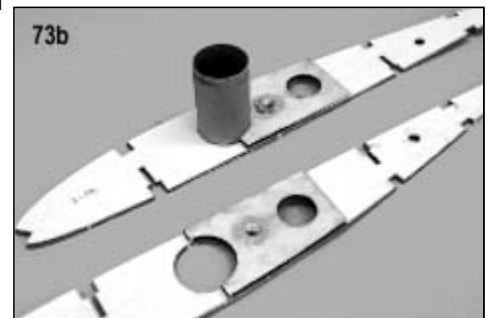

- b. Install an 8-32 Blind Nut in the small hole in each of the W-1A ribs.

- 74a. Tape or pin the one of the wing panel plans down on a flat building board. Cover with wax paper or plastic wrap.

- b. Cut to length and pin down on the plan the 1/4" sq. balsa Main Spar, the 3/16" sq. balsa Rear Spar, and the 1/8"x1/4" balsa Wing Spar. It's best to leave the spars a little long on the inboard end of the wing - they can be sanded flush with the end rib later.

- 75a. Locate the Front Spar Web and Rear Spar Web (sheet 6), and ribs W-2 (sheet 3), W-3 (sheet 1), W-4 (sheet 4), and W-5 (sheet 5). Insert the W-2, W-3, W-4, and W-5 ribs into their slots in the spar web. Set this assembly in place on the spars. NOTE: If you are building the Clipped Wing Cub, the correct Front Spar Web and the Rear Spar Web are on sheet 25. The wing ribs are all the same, but there are 2 less W-4 ribs in a Clipped Wing Cub wing panel.

- b. Slip the W-1 rib assembly that you made in step 73 in place at the root end of the wing panel. Remember, the side with the W-1A and the blind nut must be on the inside of the wing.

- c. Now carefully pin all the spar webs and ribs to the spars, starting with the W-1 rib. Make sure W-1 lines up right on the lines on the plan and pin it in place. Then, pin the spar web next to W-1 down to the spar, making sure it is up tight against W-1.

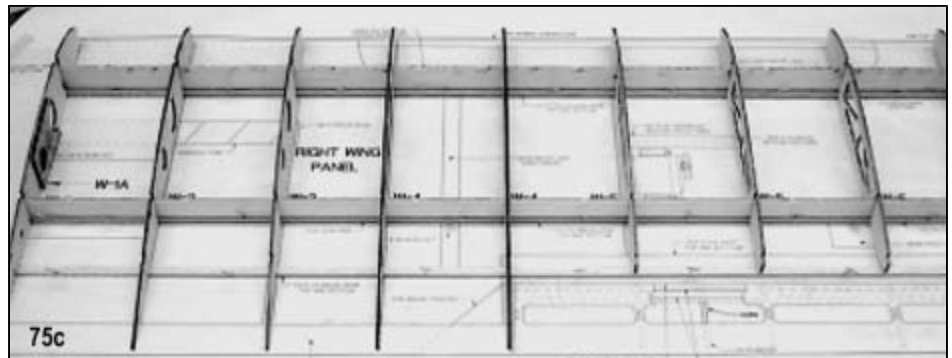

Proceed down the length of the wing panel, pinning the parts to the spars. You may notice as you are going along that some of the ribs may not line up exactly with the plan. This is because the plan paper can shrink or expand a little bit in size with climate changes. Don't worry about it. As long as W-1 is in the correct position, and the rest of the ribs are fitted into their proper slots in the spar webs (which don't ever change), the wing panel will turn out OK. When you get to the last rib, it shouldn't be off more than an 1/8" or so.

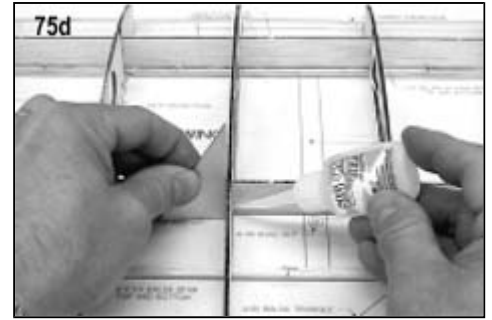

d. Begin gluing all the joints of the wing assembly together with Thin CA. Hold a 90 deg. triangle up against the ribs while gluing them to insure that they are 90 deg. to the building board.

76a. Carefully slide the phenolic tube Wing Joiner Sleeve (from step 72) into the appropriate holes in ribs W-1, W-2, and W-3. Glue the tube to the ribs.

b. Cut to length and glue in place the three top spars: 1/4" sq. balsa Main Spar, 3/16" sq. balsa Rear Spar, and 1/8"x1/4" balsa Wing Spar.

77. Locate the pre-shaped balsa Leading Edge. Notice that it is not symmetrical! Hold the Leading Edge against one of the wing cross-section drawings on the plan, and after you are sure that you have it matched up correctly, mark an "up" arrow on one end. Then, cut it to length and glue it in place in the front notches of the ribs. Make sure you glue it into the wing right side up!

78. Cut a piece of 3/32"x1"x13-3/4" balsa T.E. Sheet from the 36" stock provided. Glue it in place on the ends of the W-1, W-2, W-3, and W-4 ribs. Make sure the back edge of the T.E. Sheet is right on the line on the plan.
NOTE: If you are building the Clipped Wing Cub, cut the piece to 5-7/8" long and glue it to the W-1, W-2 and W-3 ribs - there is no W-4 rib at this location.



79. Cut a piece of 3/32"x3/4"x21-1/4" balsa from the 24" stock provided. This is for sheeting the rear edge of the aileron bay. Glue it in place to the ribs and to the 1/8"x1/4" wing spar. Look closely at the drawing - note that the inboard end of this sheeting should extend past the wing rib at the inboard end of the aileron about 3/16", so that it will line up with the cap strips to be put on that rib later.



80a. Use a long straightedge to true up one edge of a 3/32"x3"x36" balsa sheet for the wing leading edge sheeting. This edge will go against the rear face of the shaped leading edge that is already glued on the front of the wing. Trial fit the leading edge sheet to the wing to figure out where to trim the back edge. You want the back edge of the sheeting to end up sitting halfway across the 1/4" top main spar, leaving the rear of the spar exposed 1/8" for the cap strips and center sheeting.

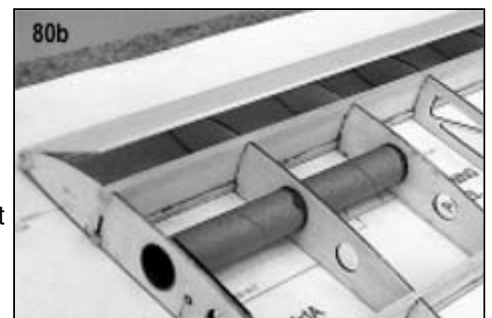

b. Once you've got the leading edge sheet trimmed to fit, glue it in place. We've found the easiest way to accomplish this is to do it in two steps.
1) Start by gluing the front edge of the sheet to the top rear face of the shaped leading edge. Apply a bead of glue along the entire length of the sheet, on its front edge only. Set the sheet in place against the shaped leading edge, holding it up at about a 45 deg. angle. Spray this joint with CA accelerator.

2) When dry, apply glue along the ribs and the front half of the top spar. Uniformly press the sheet down onto the ribs and spar. Use a straightedge and weight to hold the sheet flat to the spar and spray with accelerator.

Builder's Tip: You may need to wet the outside surface of the sheet slightly to make it bend over the ribs easier.

81. Locate the 3/32"x3" balsa sheet left over from sheeting the nose of the fuselage. This will be used for sheeting the top of wing between ribs W-1 and W-2, from the main spar all the way back to the trailing edge. Cut lengths of the balsa sheet to fit over the W-1 and W-2 ribs, and glue in place.

Note: Be sure to remove all the pins from the ribs and spars between the W-1 and W-2 ribs.

82a. Cut to length and glue in place the 3/32"x1/4" balsa Cap Strips over ribs W-3, W-4, and W-5. Carefully study the plans so you will know which Cap Strips should be put on centered over the rib and which ones should be put on along the edge of a rib.

b. The trailing edge of the tip rib should be capped with a short piece of the 3/32" sq. balsa left over from the fuselage bottom corner stringers.



83. When everything is dry, remove the wing panel from the building board. Thoroughly inspect your work and re-glue all joints with a small bead of Medium CA .

84a. Locate the plywood Front Strut Mounts, Rear Strut Mounts, and Jury Strut Mounts (sheet 15). Lay them in place on the wing plan, carefully centering the holes in the mounts with the blind nuts on the plan. Now lay the wing panel back in place on the plan, on top of the strut mounts. Carefully line the wing up with the plan. One at a time, glue the strut mounts to the wing structure, making certain you get them in the proper location.

b. Locate the Strut Mount Doublers (sheet 15). Determine which doubler fits behind which strut mount, and then glue them in place inside the wing. When dry, use a 9/64" drill to re-open the holes for the blind nuts.

c. Install 4-40 Blind Nuts in the holes from the inside, gluing them to the strut mount doublers.

85a. Pin the wing panel on the building board upside down along the main spar. Using scrap wood to support the leading and trailing edges of the wing. It is important to properly support the wing panel during the next step in order to avoid inducing a warp into the structure.

b. Locate the Bottom L.E. Sheeting (sheet 12). Check the fit of the Bottom L.E. Sheeting to the wing structure, especially around the strut mounts. Bevel the front edge of the Bottom L.E. Sheeting slightly with a sanding block to achieve a good joint with the back of the formed balsa leading edge. When everything fits properly, glue the Bottom L.E. Sheeting in place in the same manner you did the top leading edge sheeting in step 80b.

NOTE: If you are building the Clipped Wing Cub the Bottom L.E. Sheeting is in laser-cut sheet 24.

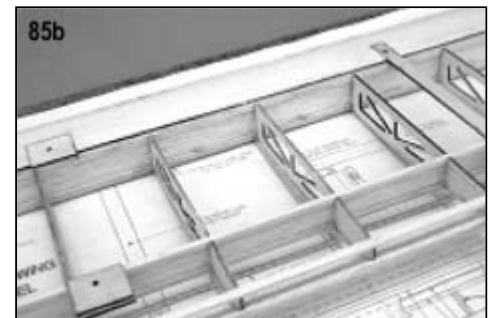

86. Cut to length and glue on the bottom 3/32"x1"x13-3/4" balsa T.E. sheet (remember step 78).
NOTE: It's 5-7/8" long if you're building the Clipped Wing Cub.

87. Cut to length and glue on the bottom $3/32 \times 3/4 \times 21-1/4$ " balsa sheet for the rear edge of the aileron bay (remember step 79). When dry, use a sanding block sand the top and bottom sheets even with the $1/8 \times 1/4$ " wing spars.
88. Trim to length the $1/8 \times 1 \times 24$ " balsa sheet that caps off the aileron bay. Glue it in place, using tape or pins to hold it until dry. When dry, carve and sand off the overhanging excess $1/8$ " sheet flush with the rest of the wing.
89. Cut lengths of $3/32 \times 3$ " balsa to sheet over the bottom of ribs W-1 to W-2, from the main spar all the way back to the trailing edge (remember step 81).
90. Cut to length and glue in place all the $3/32 \times 1/4$ " balsa Cap Strips for the bottom of the wing (remember step 82a). Note, that here on the bottom of the wing, the two Cap Strips on each side of the aileron servo bay should not be centered over the ribs, as they were on top of the wing. These two cap strips should be glued along the edge of the ribs so they are completely outside the servo bay.
91. The trailing edge of the tip rib should be capped on the bottom with a short piece of the $3/32$ " sq. balsa (remember step 82b).
92. Glue the $3/32$ " balsa Triangle (sheet 25) in at the inboard end of the aileron bay.

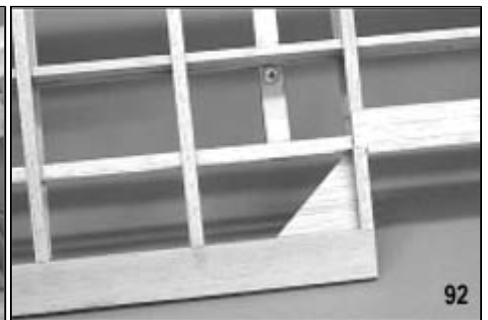
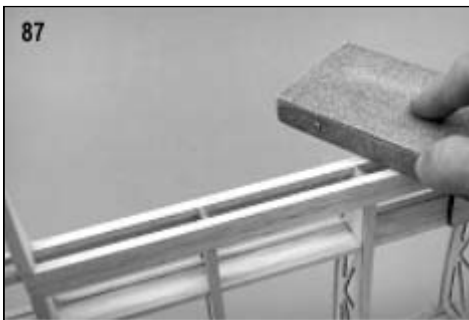

93. When dry, unpin the wing panel from the building board. Use a large sanding block with 80 grit paper to carefully smooth the entire wing panel. The goal is to only level out any mismatched areas, not to do the final sanding. Sand off any overhanging balsa sheeting or spars flush with the root rib and the tip rib.

Wing Tip

94. Locate parts TR-1 and TR-2 (sheet 11). These are small subribs that go on the outside of the last W-4 rib at the tip end of the wing panel to help support the wing tip sheet. Refer to crosssection W-4 one the plane to familiarize yourself with their precise location. Then, glue them in place on the tip rib.
95. Locate the plywood Wingtips (sheet 27) and balsa parts TS-1, TS-2, and TS-3 (sheet 11). Glue the balsa parts in place on the top and bottom of the plywood Wingtip.



96. Locate parts TB-1 (sheet 11), and TB-2 (sheet 5), and glue them in place on the tip end of the wing panel. TB-1 goes against the ends of the $1/4$ " sq. balsa Main Spars, and TB-2 goes against the ends of the $3/16$ " sq. balsa Rear Spars, as shown on the plans. Make sure these parts are 90° to the rib.



97. Locate plywood rib W-6 (sheet 11) and set it in the notches in TB-1 and TB-2. Then, pin the Wingtip assembly (from step 24) in place to the ends of TB-1 and TB-2, to rib W-6, and to the leading and trailing edges of the wing panel. At the leading edge, make sure the Wingtip lines up with the back edge of the shaped balsa leading edge piece. At the trailing edge, use a 90 deg. triangle to make sure that the tail end of the end rib doesn't get pushed out of shape while you are gluing on the wingtip. Once you have all the pieces in correct alignment, glue them together.

98. Locate the 1/2"x1"x2" balsa Wing Tip Block and glue into place at the front of the wingtip.

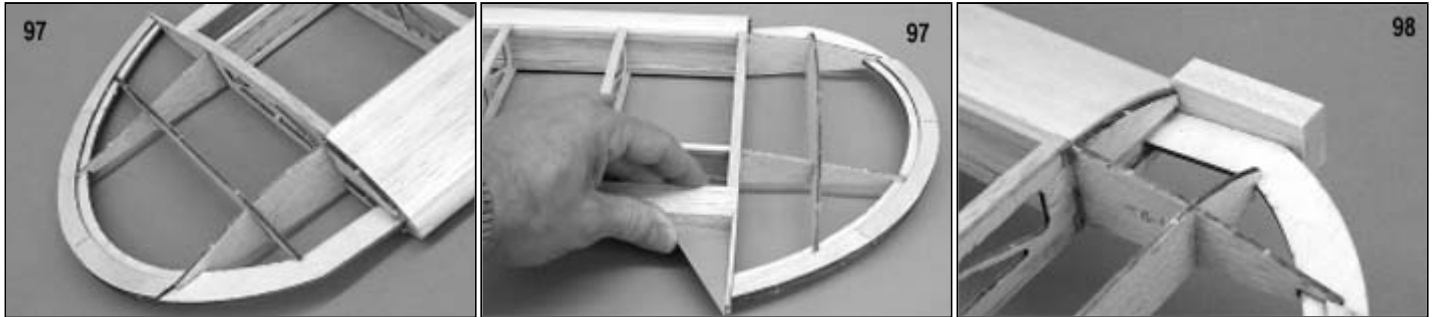

99. Sheet the front of the wingtip, top, and bottom with 3/32"x3" balsa sheet.
100. Glue 3/32"x1/4" balsa capstrips to the top and bottom of rib W-6.
101. Carve and sand the tip block and the tip sheeting to flow into the wing leading edge and the wingtip.
102. Tape a piece of plain paper over one end of your sanding block to protect the capstrip while you sand a bevel in the edge of the balsa TS-1, TS-2, and TS-3. Do this to the top and bottom of the wingtip.



103. Finish the wingtip by sanding the trailing edge of the wing panel end rib to blend in flush with the wing tip. Also, round off the outside edges of the wingtip plate.

Ailerons

- 104a. Cut two 3-3/8" long pieces of 1/4"x1/2"x16" grooved basswood Hatch Rail material to fit between the two W-5 wing ribs. Glue one of the pieces right in front of the 3/16" sq. rear spar for the rear Hatch Rail. Study the plan drawings carefully to understand the orientation of the Hatch Rails. Note that the top edge of the Hatch Rail should be flush with the cap strips on the bottom of the wing.
- b. Lay the plywood Aileron Hatch (sheet 7) in place on the lip of the rear Hatch Rail. Now, place the front Hatch Rail on the lip so you can determine the exact location for the front Hatch Rail. Glue the front Hatch Rail in place to the ribs.
- c. Lay the plywood Aileron Hatch on the plan to make sure you understand where the slot for the servo arm should end up. Then, lay the Aileron Hatch in the same position in the wing (if you install it wrong, the pushrod will not line up with the aileron horn). Drill pilot holes in the Hatch Rails with a 1/16" drill bit, using the holes in the Hatch as a guide. Screw the Hatch in place with #2 x3/8" Sheet Metal Screws.

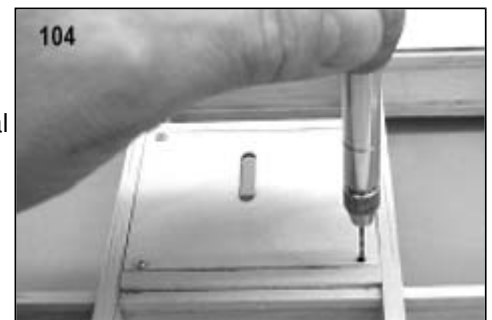

- 105a. Pin the Aileron Bottom Sheet (sheet 9) flat onto the building board.

- b. Cut a piece of 1/8"x1/4" balsa stick for the bottom Aileron Spar and glue it in place at the leading edge of the Aileron Bottom Sheet.

c. Glue seven balsa Aileron Ribs (sheet 11) in place, locating them in the slots in the Aileron Bottom Sheet.

d. Locate the plywood Aileron Horn Mount (sheet 27). Notice the small hole in the part. This is where the nylon control horn will be screwed on later. In order to make that installation of the control horn easier later on, it's a good idea to pre-thread the hole now by screwing in a #2 x3/8" Sheet Metal Screw and then taking it back out. Do this a couple times and then, after the screw is out, soak a little Thin CA glue in the threads to toughen them up. When done, glue the plywood Aileron Horn Mount in place on the Aileron Bottom Sheet - locate it 5-1/8" from the inboard end of the aileron (see plan).



106a. Cut a piece of 1/8"x1/4" balsa stick for the top Aileron Spar and glue it in place in the notches of the ribs.

b. Use a small sanding block to taper the back edge of the Aileron Bottom Sheet to match the angle of the ribs.



107a. Trial fit the Aileron Top Sheet (sheet 8). Adjust if necessary, then glue it in place.

b. Remove the aileron from the building board and block sand the top and bottom sheets smooth. Also, sand the two 1/8"x1/4" Aileron Spars flush with the front face of the ribs.

c. Finish off the front of the aileron by gluing on a piece of 1/8"x1" balsa. When dry, carve and sand off the overhang flush with top and bottom aileron sheet.

108a. With a razor saw, cut off the base of a small Nylon Control Horn (4 holes). Inlet the bottom of the aileron sheeting to allow the Nylon Control Horn to be slid in place alongside the plywood Aileron Horn Mount. Before cutting, study the wing plan and the cross-section drawings to familiarize yourself with how the Nylon Control Horn should be installed in the aileron. Notice that the horn should be installed on the outboard side of the plywood Aileron Horn Mount (installed in step 205d). Also, determine how far into the aileron the horn should be located.

b. Hold the Control Horn in position against the plywood mount and mark the location of the pre-threaded hole onto the horn. Remove the Control Horn and drill the hole with a 3/32" bit. Then, apply a small amount of epoxy to the horn and screw it securely in place against the plywood mount.

c. Fill in behind the horn, on the bottom of the aileron, with 3/64"x3/8" scrap balsa to provide a place to attach the covering material later.



d. Smear a little more epoxy glue over the screw and horn assembly inside the aileron to make sure it never comes loose.



Aileron Servo Installation

109. Lay your aileron servo on its side with a 1/32" thick scrap shim of plywood or cardboard underneath it. Then, place the 1/4"x3/4"x7/8" basswood Aileron Servo Mounts under the servo lugs and mark the location of the servo mounting holes onto the mounts. Drill 1/16" dia. pilot holes for the mounting screws.

110. Mount the servo to the mounts using the grommets, eyelets, and screws that came with the servo.

111. Position the mounted servo on the plywood Aileron Hatch, centering the servo arm in the slot. Glue the servo mounts to the hatch cover. Make sure you glue it to the correct side of the slot so the pushrod will line up with the aileron horn. The plan shows the proper arrangement.

112. Mount the aileron servo/hatch assembly in the wing. Use a 12" aileron extension cable (not supplied) to extend the servo wire to the end of the wing panel.

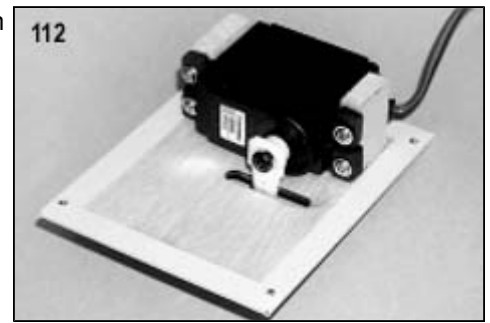

CONGRATULATIONS!

**You have now completed one wing panel and one aileron.
Repeat the steps to build the opposite wing panel and aileron.**

Mounting The Wings

- 113a. Locate the 7/8" od x17-1/2" aluminum tube for the Wing Joiners. Cut two 8-3/8" long pieces.
- b. Slide the aluminum tube Wing Joiners inside the phenolic tube sleeves that are built into the root ends of both wing panels. Push them all the way in, until they bottom out against the plywood end caps of the phenolic sleeves. That should leave about 1-3/16" of aluminum tube sticking out of the end of the wing panel.

114. Locate the 3/16" dia. x6" hardwood Rear Wing Dowel. This dowel goes completely thru the cabin center section and sticks out on both sides. It's purpose is to engage the aft portion of the wing panels, to prevent them from pivoting around the aluminum tube Wing Joiner at the front. Slide the dowel thru the small holes at the rear of the cabin center section, until there is an equal amount of dowel sticking out each side of the fuselage.



Note: You can glue the dowel in the center section at this time if you wish, or as we prefer, you can wait until after the fuselage is covered to glue the dowel in permanently.

115. Mount the wing panels on the fuselage by sliding the protruding part of the aluminum Wing Joiner into the sleeve in the center section, while at the same time sliding the protruding Rear Wing Dowel into the wing panel.
116. Use an 8-32 x1/2" Socket-Head Bolt along with a #8 Flat Metal Washer, from the inside of the cabin, to hold the wing panel up tight against the fuselage. Remember, 8-32 Blind Nuts were mounted inside the W-1 rib for this purpose way back at the beginning of the wing panel construction.

Wing Struts

The Front Wing Struts for the Piper J-3 Cub are 1/4"x1/2"x24-1/4" spruce, and the Rear Wing Struts are 1/4"x3/8"x24-1/4" spruce. Study the J-3 Wing Strut Plan (plan sheet 3) to understand the design of the wing struts. Notice that the Front and Rear Struts will be joined permanently together into a one-piece "V"-shaped wing strut assembly.

NOTE: If you are building the Clipped Wing Cub, the Front and Rear Struts are both made of 1/4"x1/2"x24-1/4" spruce. The Clipped Wing Strut Plan is on plan sheet 4.

- 117a. Lay the spruce Front Wing Strut down on the plan. Mark and cut the ends of the spruce to match the plan, being careful to get the overall length exact.
- b. Lay the spruce Rear Wing Strut down on the plan. Cut the lower (fuselage) end of this strut as shown on the plan. It must be cut at an angle to mate up properly with the Front Wing Strut. After you've got that end done, mark and cut the other end of the Rear Wing Strut to proper length.
- c. Mark the slots to be cut in each end of the spruce struts. Cut the slots down the middle of the sticks with a band saw or small hand saw.

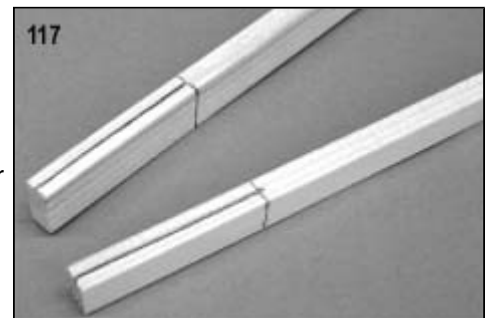

- 118a. Locate two .060"x3/8"x2-1/4" pieces of aluminum for the Fuselage Strut Fittings. Lay them on the Fuselage Strut Fittings drawing (plan sheet 3) and mark the locations for the 1/8" and 3/32" dia. holes. Clamp the part in a vise and drill the holes (use a drill press if available).

b. Round the two outside corners of the fittings with a file or grinder.

c. Lay the Fuselage Strut Fitting back over the plan pattern and mark the bend line exactly where shown. Clamp the part in a vise right at the line, and gently bend it to the angle shown.

119. Hold the Fuselage Strut Fittings in place on the bottom of the fuselage and mark the location of the two mounting holes. Drill the holes with a 1/8" dia. bit. Mount the Fuselage Strut Fittings to the fuselage with two 2-56 x 3/8" Bolts and 2-56 Blind Nuts. Glue the Blind Nuts on the inside of the fuselage.

120. Inside the fuselage, add a 1/2" balsa triangle to the front edge of the rear landing gear block, between the blind nuts.

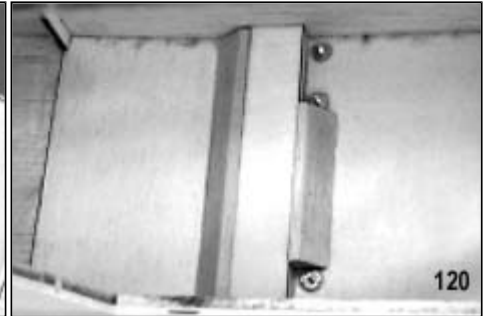
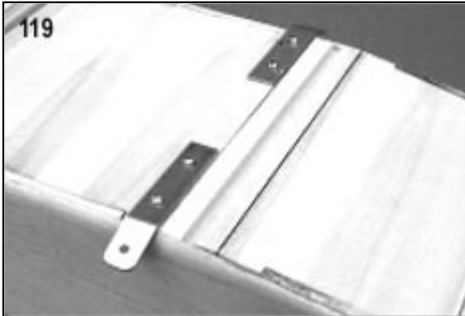
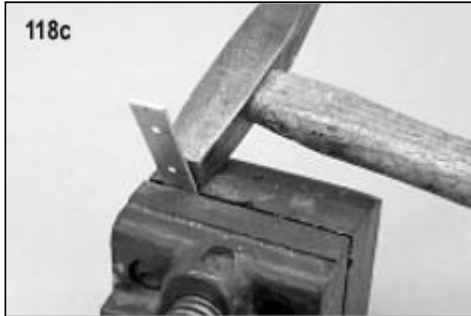

121a. Locate four .060"x3/8"x2-1/4" pieces of aluminum for the Upper Strut Fittings. Lay them on the Upper Strut Fittings drawing (plan sheet 3) and mark the locations for the 1/8" and 3/32" dia. holes. Clamp the part in a vise and drill the holes.

b. Round the two outside corners of the fittings with a file or grinder.

c. Bend the Upper Strut Fittings as shown on the plan, making two #1 and two #2 fittings. The difference between the #1 and #2 Upper Strut Fittings is only in the slant of their bend lines. Make sure you produce two of each type. Mark the bend line exactly where shown, then clamp the part in a vise right at the line and gently bend it to about a 20 degree angle.

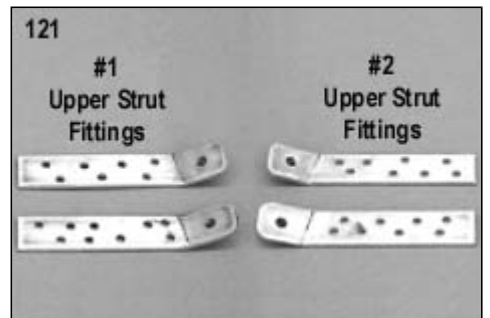

122a. Locate two .060"x15/16" (tapered) x2-3/16" aluminum Lower Strut Fittings. Lay them on the Lower Strut Fittings drawing (plan sht.3) and mark the locations for the 1/8" and 3/32" dia. holes. Clamp the part in a vise and drill the holes.

b. Round the two outside corners of the fittings with a file or grinder.

123. Epoxy the spruce Front and Rear Wing Struts onto the aluminum Lower Strut Fittings. Double check them against the plan to make sure the "V" angle is correct. Let dry.

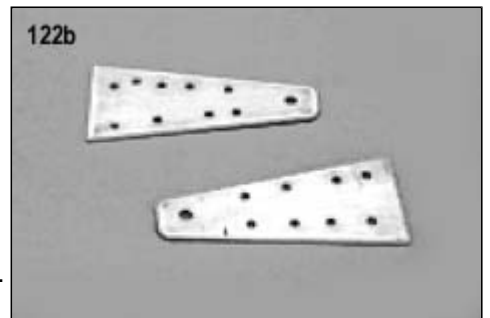

124. Next, we need to trial fit the wing strut assemblies on the airplane, in preparation for gluing the Upper Strut Fittings into the struts.

a. Bolt the wing panels in place on the fuselage.

b. Fasten the wing strut assemblies in position, one on each side of the fuselage, bolting the Lower Strut Fittings to the Fuse Strut Fittings with 4-40 x3/8" Socket-Head Bolts and Hex Nuts.

c. Bolt the Upper Strut Fittings to the plywood strut mounts built into the wing with 4-40 x3/8" Rd.Hd. Bolts.

d. Check the fit of the Upper Strut Fittings into the slots in the top ends of the wing struts. If they don't line up properly, double check to see that you've got the correct upper fitting in the correct strut. If it's not that, you may have to adjust the bend angles of the upper strut fittings and/or the fuselage fitting slightly to get a good fit.

RIGHT WING

Use a #1 Upper Strut Fitting for the Front Strut
Use a #2 Upper Strut Fitting for the Rear Strut

LEFT WING

Use a #2 Upper Strut Fitting for the Front Strut
Use a #1 Upper Strut Fitting for the Rear Strut

e. When satisfied with the fit, take the Upper Strut Fittings off one at a time, apply epoxy, slip the fitting back into the slot, bolt it back in place, wipe off any excess glue, and then let dry.

125. When dry, remove the strut assemblies from the airplane. Carve and sand the spruce Wing Struts to finished shape.

126. Reinforce the ends of the spruce struts with a layer of fiberglass cloth and thin CA glue. Also, cover the areas near the center of each strut where the jury struts will go with fiberglass cloth. When dry, sand smooth.



127. Lay the wing strut assembly on the plan and mark the location for the 2-56 x3/8" Flat-Head Bolts that hold the bottoms of the brass Jury Struts. Drill a 3/32" dia. hole through the spruce struts at these locations. Countersink the holes on the bottom of the struts so that the heads of the bolts will be flush with the spruce. Then, thread the bolts in place and leave them there.

128a. Re-attach the wing strut assemblies to the airplane.

b. Cut two 3-3/8" long pieces of 5/32" od brass tubing for the Jury Strut Spreader.

Note: If you are building the Clipped Wing Cub, the Jury Strut Spreader should be 2-7/8" long.

c. Flatten both ends of the Jury Strut Spreader as needed to clear the spruce struts (approximately 3/8" on each end as shown on the plan).

Builder's Tip: A regular hand pliers works best for flattening and bending the ends of these brass tubes.

d. Hold the Jury Strut Spreader in place on the wing struts and mark locations of the holes near each end. Drill the holes with a 3/32" dia. bit.

129a. Cut two 4-3/4" long pieces of 5/32" od brass tubing for the Front Jury Struts.

Note: If you are building the Clipped Wing Cub, the Front Jury Struts should be 5-5/16" long.

b. Flatten the ends of the Front Jury Struts and mark the location of the holes. Drill the bottom hole with a 3/32" dia. bit. Drill the top hole with a 1/8" dia. bit. There are patterns on the plan to use as a guide for bending the Front Jury Struts to shape. Be sure to make a right and a left!

130a. Cut two 4-7/8" long pieces of 5/32" od brass tubing for the Rear Jury Struts.

Note: If you are building the Clipped Wing Cub, the Rear Jury Struts should be 5-1/4" long.

b. Flatten the ends of the Rear Jury Struts and mark the location of the holes. Drill the bottom hole with a 3/32" dia. bit. Drill the top hole with a 1/8" dia. bit. There are patterns on the plan to use as a guide for bending the Rear Jury Struts to shape. Be sure to make a right and a left!

131. Bolt all the Jury Strut tubes in place on the Wing Struts. Epoxy together the lower ends of the Jury Struts and the Spreader where they overlap each other and the spruce wing struts. Use 2-56 Hex Nuts to fasten them to the 2-56 Bolts that are already in the Wing Struts. Use 4-40 x3/8" Rd.Hd. Bolts to fasten the top ends of the Jury Struts to the wings.



Main Landing Gear

132. Locate the formed wires 5/32" Main Landing Gear, 5/32" L.G. Rear Brace, 1/8" Top Shock Strut, and 1/8" Bottom Shock Strut. Sand all the wires with 220-grit paper, then wipe clean with acetone or paint thinner.

133a. Place the Main Landing Gear wire in the front grooved landing gear block in the bottom of the fuselage. Place the L.G. Rear Brace wire in the aft grooved landing gear block. The Main Landing Gear should be perpendicular to the bottom of the fuselage, while the L.G. Rear Brace should be angled forward to meet it near the axle. You will have to trim the groove in the rear block slightly to allow the Rear Brace wire to swing forward.

b. The wires are held in the grooved blocks with the four Nylon Landing Gear Straps provided. The straps should be installed all the way to the ends of the grooved blocks, right up against the wire where it exits the block. This is done to insure the landing gear cannot shift sideways in a rough landing. Mark the location of the holes on the grooved blocks. Then, use a 3/64" bit to drill a pilot hole for the # 2 x3/8" Sheet Metal Screws.

134a. Bind the ends of the Main Landing Gear, the L.G. Rear Brace, and the 1/8" Bottom Shock Strut together near the axle with the soft copper wire supplied. It's easiest to first tack glue them together with Medium CA to hold them in alignment while you wrap them. If the wires don't line up exactly right with each other, rebend as necessary to get them to fit properly. Make the copper wire wrapping as tight as you can, with each strand of copper wire right next to the previous one. There should be no gaps between the strands of copper wire. Don't worry about running out of copper wire, as we have included extra to help insure that you can make these bindings very strong.

b. Next bind the 1/8" dia. Top Shock Strut wire in place at the top of the Main Landing Gear wire. Position this wire carefully (see front view plan). The middle bend of this Top Shock Strut should contact the middle bend of the Bottom Shock Strut. For flying, the Top and Bottom Shock Struts will be bound together at this spot by rubber bands, which will serve as an effective shock absorber.

c. When you have all the wires bound together in proper alignment, solder the bindings securely with normal rosin core solder. Be sure to use a soldering iron or torch with enough heat output to get the wires and bindings hot enough for the solder to flow smoothly. Also, use plenty of solder paste to help the solder flow completely around and thru the bindings. Protect the fuselage during the soldering operation with a cloth so that dripping solder or paste will not fall on the wood. After both axles are soldered and cooled off, carefully remove the wires from the grooved blocks.

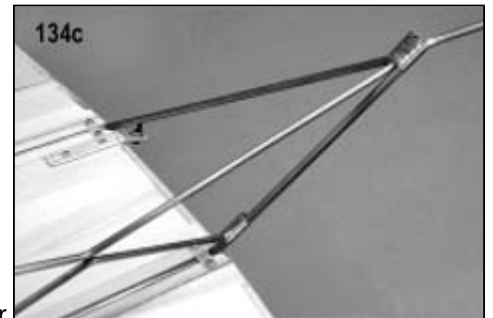

135. After all the solder joints are cool, file and sand them to smooth out any prominent bulges in the bindings. Clean all the wires and joints with dope thinner or other suitable solvent.

136a. A sheet of 3/16"x6"x8" balsa is provided for fairing in the sides of the Main Gear. Cut out a right and left fairing to fit between the gear wires. Note proper grain on the plan. Epoxy the balsa fairings in place and allow to dry.

b. Using a sanding block, sand the balsa fairings flush with the wires if they are sticking out. Also, sand the top edge of the fairings round.

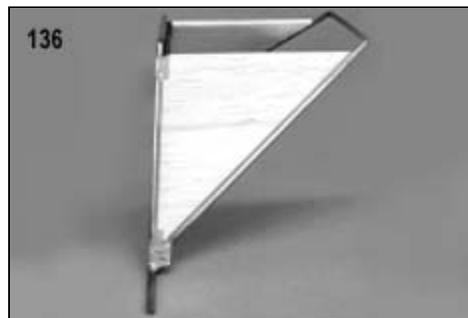

b. Fill in any voids in the landing gear fairings with extra epoxy glue or epoxy putty.



137. Solder a #6 Flat Metal Washer on each of the axle wires, right up against the bend in the wire, to keep the wheels from binding on the bend.

Attaching The Tail Surfaces

138a. With the wings and struts mounted to the fuselage, place the stabilizer in position. Secure it lightly in place with a couple pins.

b. CHECK TOP VIEW ALIGNMENT: Use a measuring tape to check the distance from one stab trailing edge tip straight ahead to the wing trailing edge. Now make the same measurement on the other side of the model. The two measurements should be the same! If not, adjust the stab accordingly. Once the alignment is correct, put in some more pins to keep it from moving. Use a pencil to mark the location of the fuselage sides on the bottom of the stab.

c. CHECK FRONT VIEW ALIGNMENT: Step back a few feet and use your eyeballs to make sure the stab is lined up with the wings. If not, you'll need to adjust the top of the fuselage sides until it does.

d. Unpin the stabilizer from the fuselage and apply epoxy glue to the joint. Pin the stabilizer back in the exact same spot, using the pencil marks on the bottom as your guide. Recheck the front view alignment and adjust if necessary, using the pins to hold it in correct position until the glue dries. Builder's Tip: We recommend slow drying epoxy glue (not 5 minute) for this joint to allow adequate time to get the stabilizer back in exact alignment before the glue dries.

139. Pin the vertical fin in position on the stab (without any glue). Locate the two balsa Tail Fairings (sheet 20) and pin them in place along each side of the fin (again no glue). Mark the Tail Fairing's location on the top of the stabilizer with a pencil. This line shows where you will stop the covering on the top of the stab. Remove the fin and tail fairings from the airplane.



140. Cover the stabilizer and elevators according to the instructions provided with your covering material (see covering instructions further ahead in the book).

141a. Refer to the plans and then mark the locations for the SIG Easy Hinges on the stabilizer and elevator. Carefully cut a very shallow slit at the hinge location using a sharp #11 blade in your modeling knife. This first slit should be very shallow so you can better control the direction of the knife. It's main purpose is to establish the hinge slot in the right location, so concentrate on staying on the marked line. Don't try to cut too deep on the first pass. Make the slit a little wider than the actual hinge.



b. Now make 3 or 4 more cuts in the slit, going a little deeper each time. As you make additional cuts, concentrate on staying in the slit and aiming straight into the center of wood so that it won't come out the side of the of the part.

142a. After the slots have been cut, insert an Easy Hinge halfway into each slot in the stabilizer. If the hinge is difficult to push in, re-insert the knife and move it back and forth in the slot a few more times. **DO NOT GLUE THE HINGES IN AT THIS TIME.** Now, carefully slide the elevator onto the exposed half of the hinges. You will find it easiest to slide the part onto the hinges at an angle, one hinge at a time. To set the proper amount of gap between the parts simply deflect the control surface to the maximum amount of travel desired in each direction. This will automatically set the proper hinge gap.

b. Place three or four drops of Thin CA glue directly onto the hinge in the gap. You will notice that the glue is quickly wicked into the slot as it penetrates both the wood and the hinge. Immediately turn the part over and glue the other side of the hinge. Continue this process until you have glued both sides of all the hinges.

CAUTION: SIG Easy Hinges are designed to be used with any THIN CA adhesive. Make sure you are using the thinnest variety. Do not use medium or thick CA, or any other type of glue, on Easy Hinges. Also, never use CA accelerator on Easy Hinges.

143a. Epoxy the fin securely in place. Do not put any glue on the bottom of the fin post or it may get into the rear tailwheel anchor nut. Be sure to line up the fin straight with the 1/8"x1/4" fuselage top stringer. Use a triangle to make sure that the fin is 90 deg. to the stabilizer. Pin in place and let dry.

b. Sand the front of FN-2 to blend into the top stringer.

144. Shape and glue the two balsa Tail Bairings in place. After they're glued on and dry, taper the Tail Fairings at the back to blend into the fin post.

145a. Glue a piece of scrap 1/4" sq. balsa on each side of the fin post, between the tail fairing and the top of the fuselage side. Carve and sand to blend with the fuselage and tail fairing.



b. Use a sanding block to taper the rear end of the fuselage sides to blend in with the fin post.

Note: In this photo, the right side of the fuselage shows this area before shaping. The left side shows how it should look when it's done.

COVERING AND FINISHING

No matter what brand and type of covering material you decide to use (iron-on plastic, iron-on fabric, or bare cloth and paint) the surface of your uncovered model directly affects what the covering job will look like when you are done. Poor workmanship will show right through. Now is the time to carefully inspect the surface of the entire model. Carefully sand smooth any mis-matched sheeting joints. Use a good quality, light weight filler to fill in any dents, nicks, or dings. The entire model should be final sanded with 220 grit sandpaper, progressing to 360 grit. The surfaces to be covered must be clean, dry and dust-free. Use a tack rag and/or compressed air to make sure the model is completely dusted. We would also suggest that you make sure the physical area where you will be covering the model is as clean and dustfree as possible.

Fuel Proofing

Before covering the fuselage, coat the entire front surface of the firewall with two or three coats of SIG Clear Dope, polyester or epoxy resin, and other fuel proof paint. Also, fuel proof the grooves on the main gear blocks and around the door opening.

Covering The Wings

- 146a. Begin by covering the ends of the aileron bays. Run the covering material around onto the top and bottom. Also, cover the W-1 end rib of the wing panel, again run the covering around the top and bottom of the wing about 1/8".
- b. Cover the bottom of the wing with one piece of covering material. Like all open structures, you should seal the covering down all along the outside edges of the structure first. At the root end of the wing panel, seal the covering over the edges and onto the end rib. Along the back of the wing panel, slit the excess covering at each end of the aileron bay and run the flap of covering material around the corner and seal it on to the face of the aileron opening. In the aileron servo bay, cut an "X" pattern, then iron the excess material inside the hatch area, against the ribs and hatch rails.
- c. When all the edges are fastened down, cover the top side of the wing in similar fashion.
- d. Shrink the top and bottom covering tight with a heat gun. Refer to instructions that came with your covering material.

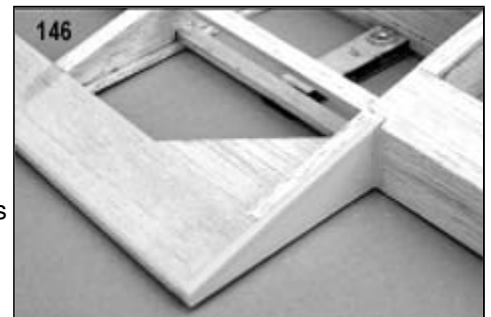

BUILDERS TIP: A good way of open small round holes in the covering, like where the wing struts bolt on, is to briefly heat the tip of a small diameter Phillips screwdriver or an awl with a butane torch. Then, quickly press the tip into the covering film, directly over the hole. The covering will melt around the edge of the hole, sealing it and leaving a perfectly round opening.

Covering The Ailerons

Start by covering both ends of the aileron with small scrap pieces. Then, cover the bottom with one piece, cutting a slot for the horn. Finally, cover the top in one piece. Shrink both sides simultaneously with a heat gun.

Covering The Aileron Hatches

Start by applying an oversize piece of covering to the top of the hatch. Then turn it over and cut out the excess at the corners to make it easier to wrap and seal the covering around the edges. Continue wrapping and sealing the covering around the edges and onto the bottom. Then, shrink the top surface tight.



Covering The Fuselage And Fin

On the full-size Cubs, the fuselage and fin are covered with one continuous piece of fabric. It bridges from the top stringers of the fuselage sides up to fin rib, producing a beautiful fillet. The construction of this model duplicates this feature. Your covering material should bridge from the balsa tail fairings up to the fin bottom rib and then, forward over the top of the fuselage. This may at first sound like a difficult job, but it's much easier than you'd think, if you proceed in the right sequence.

147a. Cut a piece of material that will cover the entire left side of the fin, the left side of the fuselage top, and all the way forward to the center section hatch.

b. Begin sealing the covering down to the fuselage top stringer, the fuselage corner stringer, and to the hatch opening at the front. Pull out any large wrinkles or sags in the covering as you work. To get more adhesion area, wrap the covering material around the sides of the stringers. That way there will be no chance that the covering will come loose.

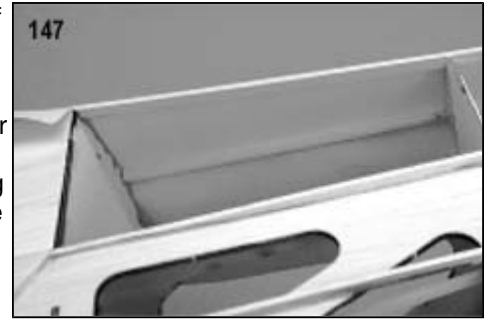

148a. Straighten out the rear end of the covering and adhere it to the tail fairing. Pull the material as smooth and tight as possible, while you iron it to the fin. Don't forget to adhere it to the fin rib as well as the outside edges.

b. Cover the other side of the fin and fuselage top with a separate piece of covering material.

c. Use a heat gun to slowly shrink both sides of the fin covering simultaneously.



149. The rest of the fuselage should be covered with three more pieces. One for the bottom, one for the right side of the fuselage (including half of the nose), and one for the left side (and other half of the nose).

150. Cover the top of removable center section hatch. Run the covering material around the edges and adhere it to the bottom.

151. Cover both sides of the door with separate pieces of covering material. Remove the latch mechanism from the door before covering it. After the door is covered, glue in the two hinges you fitted to the door way back in the fuselage construction. Glue the other ends of the door hinges into the fuselage. Then, reassemble the door handle and a latch, and make any final adjustments.

152. Cover the outside of the door window with covering material. We painted the inside with matching Cub Yellow paint. Then hinge the door window to the fuselage.



Covering The Tail Surfaces

153. The stabilizer is covered after it is mounted on the fuselage (see "Attaching The Tail Surfaces" earlier). Cover the bottom of one side first. Trim a perfectly straight edge along the side of the covering material that will butt up to the fuselage side. Adhere that edge to the stabilizer first. Then, straighten out the loose covering material and start sticking the other edges down. Wrap the material slightly over halfway around the edges. Trim off the excess. Then, cover the top side with another piece of covering material, in the same manner. After you have both sides covered, use a heat gun to shrink the covering.

154. Cover the elevators and rudder, using a separate piece of material for each side. Wait until you have both sides covered before shrinking the material tight. This helps avoid warps.

Attaching The Rudder

155. After the rudder is covered, epoxy the molded Nylon Rudder Horn at the bottom. Let dry.

156. Hinge the rudder to the back of the fuselage with three SIG Easy Hinges, following the same procedures you used to hinge the elevators to the stabilizer earlier.

Painting The Wing Struts And Landing Gear

Prime and color paint the wing struts and landing gear with a paint of your choice. Because there are metal parts involved, be sure to choose a primer that sticks well to metal. Aircraft dope does not stick as well to metal as epoxy primer does.

We've used and can recommend NELSON HOBBY SPECIALTIES water-based two-part EPOXY PRIMER for the wing struts and landing gear. Brush or spray a coat of the epoxy primer over the entire part. When dry, sand well. Put on another coat of epoxy primer, let dry, and sand again until the surface of the wood and fiberglassed area are smooth. Then, we sprayed two coats of SIG CUB YELLOW SUPERCOAT DOPE over the primer. The SIG CUB YELLOW DOPE is a pretty good color match to the SOLARTEX CUB YELLOW FABRIC covering that we used.

Cowling

157. Position the cowling over the F-1 cross-section on the plan (sheet 1) and mark the location of the center line and thrust line on the outside of the cowl. Then, use a large triangle to transfer the marks to the top of the cowling.

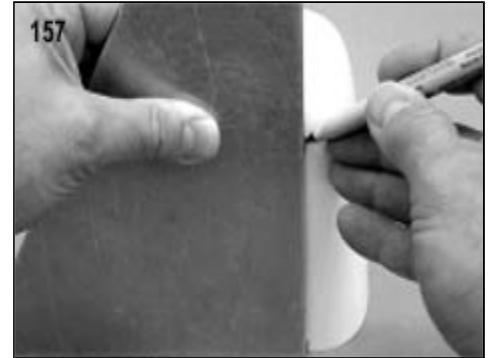

158a. With a Dremel® tool or hobby knife, cut an opening in the front of the cowling large enough for the engine's prop shaft and drive washer to fit through. Locate this hole according to the thrust line marks that you made on the cowling in the previous step.

b. Cut out the two oval shaped air intake holes in the front of the cowling, right below the prop shaft opening. Refer to the fuselage front view plan for the exact size and location.

c. Cut a 3/4"x1" hole in the "chin" of the cowling where the molded plastic air cleaner will go.

d. Make any necessary openings in the cowling to fit your particular engine, needle valve, etc.

e. An opening must be made in the bottom rear of the cowling to allow the engine cooling air to properly flow through and exit the cowling. This is absolutely necessary for proper cooling! Without an adequate exit air opening, your engine may overheat and quit. There's an old rule of thumb that says you should have 1-1/2 times as many square inches of exit area than intake area in your cowling. That ratio will keep a constant stream of fresh, cool air moving through the cowling. Inadequate exit space can cause heated air to be trapped inside the cowl, which can cause overheating and engine failure. This picture shows the size of exit air opening we have at the bottom of our Cub cowlings.

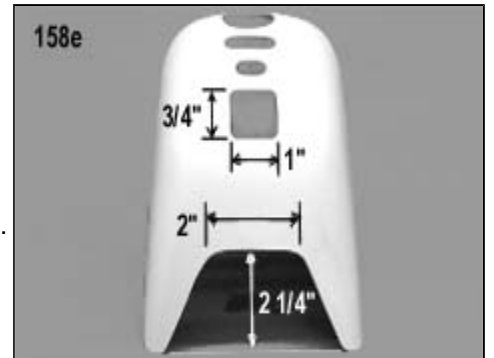

159a. Cut four 3/8" sq. x5/8" long basswood cowl mount blocks. Epoxy the blocks along the edges of the firewall, two on each side, approximately where shown in the photos and plans.

Note: You can adjust the exact location of the cowl mount blocks to suit your individual engine installation. Just make sure the outsides of the cowl mount blocks end up flush with the outside surface of the model.

b. Tape the cowling in place on the fuselage. Line it up carefully in final position. Then, drill pilot holes with a 3/64" dia. bit through the cowling and into the cowl mount blocks. Take the cowling off and open up the holes in the cowl large enough to pass the #2 x3/8" Sheet Metal Screws provided. Mount the cowling to the fuselage with the screws.

160. The fiberglass cowling has a paintable white jellcoat outer service. After sanding it with 360 grit sandpaper, you can paint it with airplane dope or almost any other common epoxy or enamel model airplane paint.

Dummy Engine

A molded ABS plastic scale-like "dummy engine" is provided to make the nose of your Cub look more realistic. The dummy engine is completely cosmetic. It serves no structural or aerodynamic purpose. To use it or not is entirely up to you. We use it on all our Cubs because it adds a lot of realism to the model.

161a. Cut out the right and left molded plastic dummy engines. The cut lines are molded right into the parts. The best procedure for trimming is to first rough out the parts with a heavy-duty scissors or shears, leaving about 1/8" outside the final cut line. Then, finish the edges by sanding it to final shape, checking the fit of the part to the side of the cowling as you go.



- b. Glue the dummy engines to the sides of the cowling. Study the photos and plans carefully to get the location exactly right.
162. Cut out the right and left molded plastic dummy engine shrouds. The cut lines are molded right into the parts. Trial fit the shrouds onto the cowl to fine tune the fit of the trimmed edges. When satisfactory, glue the shrouds in place.
163. Cut out the molded plastic Air Cleaner and glue it in place on the "chin" of the cowling.

Painting The Dummy Engine

CAUTION: Do not try to cover any of the plastic parts with iron-on covering material. The heat can damage the plastic parts.

The molded plastic dummy engine parts are made of ABS plastic, which can be painted with just about any common fuel-proof model airplane paint (dope, enamel, or epoxy). In preparation for painting, all the plastic parts should be lightly sanded to remove as much of the surface gloss from them as possible. Do not use coarse sandpaper which will leave deep scratches in the plastic. Use 360 grit sandpaper or finer.

Color paint can be brushed or sprayed directly on the sanded plastic. Primer type coats are not necessary if a thorough sanding job was done with fine paper. Do not apply heavy, wet coats which can cause an "orange peel" effect. Put on light coats and allow them to dry before applying a second coat.

The dummy engine on our prototype models were painted with 3 basic colors:

- Glossy Silver - for the cylinder heads.
- Flat Black - for the top shrouds, the cylinders fins, and for any recessed or shadowy areas.
- Flat "Steel" - For the exhaust pipes and cylinders. This isn't a standard model airplane color! You'll have to mix your own by slowly adding black paint to silver until you get a shade you like. It shouldn't be too light colored, but must provide adequate contrast with the black painted areas.

Windshield And Side Windows

164. Cut out the molded clear plastic Left and Right Side Windows. Leave about a 1/16" flange around the windows, as shown in the photo.
165. Cut out the molded clear plastic Top Window. Cut just outside the 1/8" wide raised "frame" that is molded around the outside of the flat window itself. Lightly sand the frame with 360 or finer grit paper, and then paint it to match your airplane color.
- 166a. The molded clear plastic Windshield has a cut line scribed into it. Trim the windshield out on the cut lines. The cut lines will get you close, but you may need to trim a little more as you trial fit the windshield onto the fuselage.
- b. After you've finalized the fit of the windshield, mask off the portions of the windshield that simulate the two upper cabin blocks. Sand with 360 or finer grit paper, and then paint.

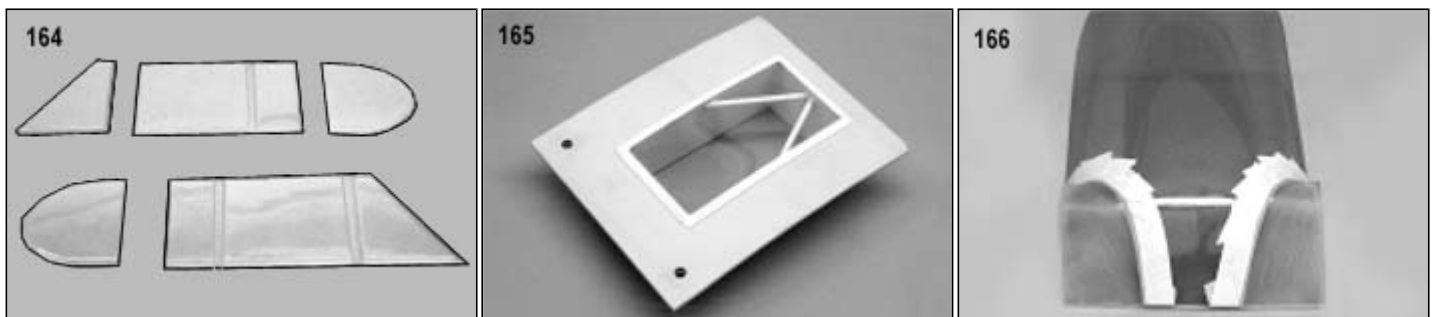

167. Glue the Side Windows and Top Window in place with few small drops of Medium CA or use a special "canopy glue" like RC-56™. Do not use CA accelerator on any of the plastic windows – it will fog them!
168. Glue the Windshield in place. When dry, cover the edges of the Windshield with 1/4" wide plastic stripping tape. This covers over any ugly gaps in the installation and gives it a more finished look. Paint the tape to match the fuselage.

Tail Brace Wires

169. Four 2-56 x10" Threaded Steel Rods are provided for the Tail Brace Wires. Cut two of the rods to 8" long (including the threaded portion) for the Top Tail Brace Wires. Cut the other two to 6-7/8" long for the Bottom Tail Brace Wires.
170. Four 2-56 Steel R/C Links and four Solder Links are provided for the ends of the Tail Brace Wires. Take all eight R/C Links and cut off the side that has the pin in it. Builder's Tip: A Dremel tool with an abrasive cut-off wheel works best for this.)
171. Screw a 2-56 Hex Nut, followed by one of the modified 2-56 R/C Links on the threaded end of each Tail Brace Wire. Solder the modified Solder Links onto the other end of each Tail Brace Wire.
172. Fit the wires to the model. Bend the ends of the links as needed to make them fit flat against the model surface. Use 1-72 x1/2" Rd.Hd. Brass Bolts and Hex Nuts to bolt the links to the stab and fin. Use two #2 x3/8" Sheet Metal Screws to hold the lower end of the Bottom Tail Brace Wires to the plywood tailwheel mount.
173. Adjust all the threaded links until the Tail Brace Wires are snug, but not pulling the tail surfaces out of shape. Then, screw the hex nuts against the links to keep them from coming loose.

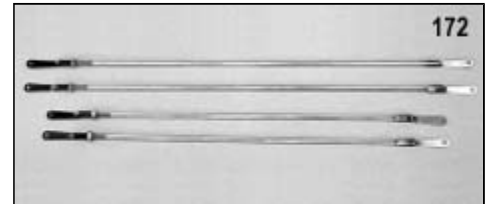
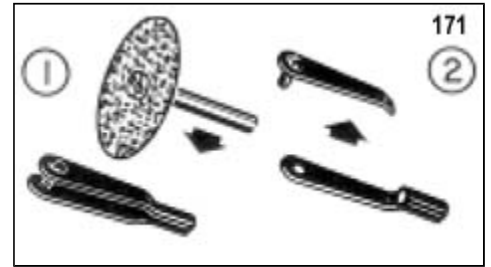

Radio Installation - Ailerons

The aileron servos and extension chords were installed earlier, before covering the wing. All that's left is to hinge the ailerons to the wing and make the aileron pushrods.

174. Use four SIG Easy Hinges to hinge each aileron to its wing panel. Use the same procedures you did in the section "Attaching The Tail Surfaces" earlier. The aileron hinges should be installed in the 3/32" balsa top sheeting of the wing and aileron (see wing cross-section drawing on the plan).
175. Screw a Nylon R/C Link onto the threaded end of a 2-56 x10" Threaded Steel Rod. Screw it on until it's halfway up the threads. Then, hook the Nylon R/C Link up to the control horn in the aileron. Fasten a Solder Link to the aileron servo arm. Center the aileron servo in neutral position. Tape the aileron itself to the wing in neutral position. Now, hold the pushrod up against the Solder Link and mark where the pushrod should be cut off. Cut off the pushrods, remove the Solder Link from the servo arm, and solder the link to the end of the pushrod. Let cool, then hook the pushrod back up and make final adjustment of the pushrod length to achieve neutral position. Repeat steps to make the opposite aileron pushrod.

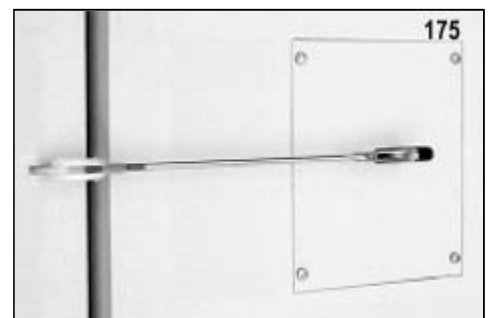
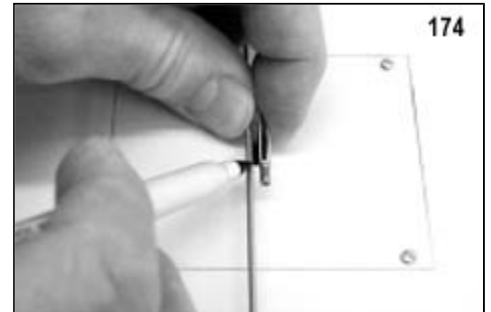

Elevator

176. Mount the elevator servo in the plywood servo tray in the fuselage.
177. Locate the .130 x36" Nylon Elevator Pushrod Tube, two 2-56 x10" Threaded Steel Rods, a Solder Link, and a Nylon R/C link.
178. Cut one of the threaded rods to 1-3/4" long (including the threaded portion). Solder a Solder Link on the unthreaded end of the wire. Screw the threaded end of the wire into the one end of the nylon tube. Try to get all of the threads screwed inside the end of the tube. This will be the servo end of the elevator pushrod.

179. Slide the unfinished end of the pushrod through the Elevator Pushrod Sleeve that is already in the fuselage. Slide it in from the servo end. Slide it in until you can hook the Solder Link in the elevator servo arm.
180. At the elevator end, cut off the excess nylon pushrod tube, leaving 2-1/2" of tube sticking out of the fuselage side.
181. Mount the Medium Nylon Control Horn in place on the bottom of the elevator with two #2 x1/2" Sheet Metal Screws. Make sure the horn lines up with the end of the elevator pushrod tube.
182. Cut a 2-56 x10" Threaded Steel Rod to 3-1/8" long (including the threaded portion). Smooth the cut end of the rod and insert it into the end of the elevator pushrod tube. When you get to the threads, screw it in until half of the threads are inside the tube and half are outside. Next, thread a Nylon R/C Link onto the exposed threads, roughly centering it on the threads. Center the elevator servo and elevator in neutral position. Then, adjust the Nylon R/C Link until it can be snapped into the control horn.

Rudder

183. Locate the parts bag for the rudder pull-pull system. Cut the .021" dia. x6 ft. Steel Cable provided into two 3 ft. long pieces. Cut the 1/8" dia. x2" piece of Heat-Shrink Tubing into four 1/2" long pieces.

184. Slide a piece of heat-shrink tubing onto the end of one of the 3 ft. cables, followed by one of the 1/2" long Aluminum Tubes provided. Then, thread the end of the cable through the outermost hole in the rudder servo output arm, giving yourself about 4" - 5" to work with. Make a half loop out of the servo arm and run the short end of the cable back through the aluminum tube. Pull the tube up to the servo arm, about 1/2" away from it. Take the short end of the cable and loop it back around and through the aluminum tubing again, pulling it tight. Use a pliers or a crimping tool to squeeze the aluminum tube tightly onto the cable, locking it in place. Cut off the excess short end of the cable. Slide the heat shrink tubing over the aluminum tube and use heat to shrink it in place. Now, repeat the steps to install the other 3 ft. cable in the opposite servo arm hole.



185. Slide a 36" length of thin music wire (not supplied) through the rudder exit guide at the back of the fuselage, then, forward through the fuselage and out the door opening. Tape the unfinished end of the pull-pull cable onto the end of the music wire and then, carefully pull the cable through the fuselage and out the exit guide. Repeat to bring the other rudder pull-pull cable out on the other side of the fuselage.

186. Mount the rudder servo in the plywood servo tray in the fuselage. Center the rudder servo with the radio system. Temporarily tape the rudder in neutral position.

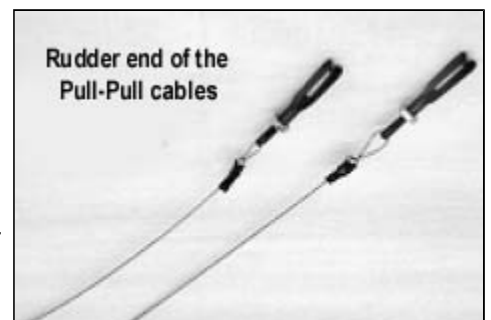

187. Locate the two Rigging Couplers, two 2-56 Hex Nuts, and two 2-56 Steel R/C Links. Screw a Hex Nut, followed by an R/C Link, onto the threaded end of each Rigging Coupler. Screw them halfway up the threads. Clip these Rigging Coupler assemblies into the outermost holes on each side of the rudder horn.

188. Working on one side of the fuselage at a time, slide a piece of heat-shrink tubing on unfinished the end of the pull-pull cable, followed by an aluminum tube. Then, stick the end of the cable through the small hole in the end of the threaded Rigging Coupler, giving yourself about 4" - 5" to work with. Make a half loop out of the rigging coupler and run the short end of the cable back through the aluminum tube. Pull the slack out of the cable as you slide the aluminum tube up to the rigging coupler, about 1/2" away from it. Take the short end of the cable and loop it back around and through the aluminum tubing again, pulling it tight. Use a pliers or a crimping tool to squeeze the aluminum tube tightly over the cable in two places, locking it in place. Cut off the excess short end of the cable. Slide the heat-shrink tube over the aluminum tube and shrink it in place. Repeat this process with the remaining cable on the opposite side of the rudder.

189. Now, with the rudder still taped in neutral, adjust the R/C links at the rudder horn to approximately the same mild tension - do not pull the cables too tight. Remove the tape holding the rudder in place, plug the rudder servo into your airborne system, turn on the transmitter and test the movement and centering of the rudder. Adjust as needed. When satisfied, tighten the hex nuts up against the end of the R/C links to lock the links in place.

Receiver And Battery Pack

The single heaviest unit of the radio system is the of course battery pack. This means that you can, if needed, locate the batteries wherever they are required in the airplane to help achieve the correct balance point. Be sure to wrap the battery pack and the receiver in foam rubber and use rubber bands or tie-wraps to secure to the model structure so that it can't move around in flight. The receiver switch can be mounted internally or externally in the fuselage side (like we did).

Radio Check

Turn the radio system on and check the functions of all the controls. Make sure they are moving in the right direction! Thousands of R/C airplanes have crashed over the years because the servos were moving the wrong way! Also, make sure all the servos are centered and working perfectly, without any binding. Correct any such problems now. With everything checked and working, now is the time to set the initial control movements.

Control Movements

After flying your Cub for awhile, getting used to its characteristics, you will likely change the control throws to suit your style of flying. But you have to start somewhere and this is where you begin.

Remember: Control surface movements should always be measured at the widest point of the control surface.

| Surface | Suggested Throw |
|-----------|------------------------------|
| AILERONS | 3/4" UP and 1/2" DOWN |
| ELEVATORS | 1" UP and 1" DOWN |
| RUDDER | 1-3/4" RIGHT and 1-3/4" LEFT |

Steerable Tailwheel Unit

190. Push the bottom end of the Formed Leaf Spring inside the molded Nylon Tailwheel Bearing. Bolt securely with the 4-40 x3/8" Rd.Hd. Bolts and the 4-40 Lock Nuts provided.

191. Prepare the Formed Tailwheel Wire for installation by first grinding or filing any burrs from both ends of the wire. Next, clamp the entire bottom fork of the tailwheel wire in a vice and bend the top shaft backward slightly, so that when installed the tailwheel will be swept back slightly as shown in the full-size side-view plan.

192. Solder a #2 Flat Metal Washer just above the top bend of the Formed Tailwheel Wire. The purpose of this washer is to keep the wire from riding up too high into the Nylon Tailwheel Bearing and causing a bind. A second #2 Flat Metal Washer is provided to solder onto the axle portion of the tailwheel itself to keep the tailwheel itself from binding against the bend of the wire.

193. Install a 1" diameter Tailwheel (not furnished) on the axle. Solder another #2 Flat Metal Washer on the axle to hold the tailwheel in place.

194. Insert the 3/32" Wheel Collar into the round cavity in the bottom of the molded Nylon Steering Arm. Align the set screw hole in the wheel collar with the hole into the steering arm. Install the 4-40 x3/16" Rd.Hd. Bolt through the steering arm hole, threading it into the wheel collar.

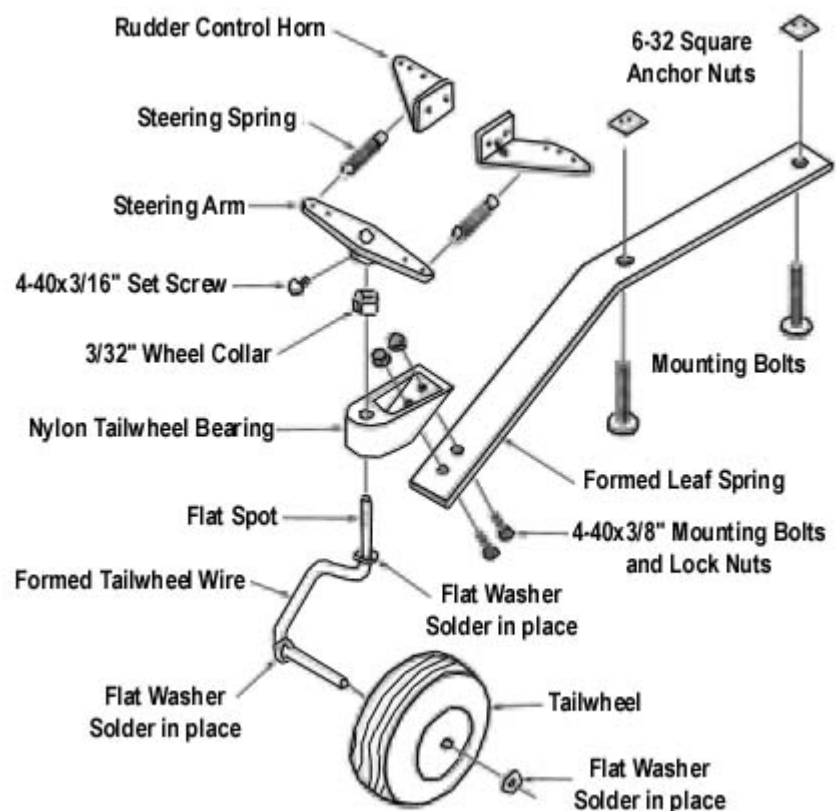

195. Insert the top of the Formed Tailwheel Wire through the Nylon Tailwheel Bearing and secure in place with the Steering Arm. File or grind a flat spot on the wire where the set screw will make contact.
196. The two tailwheel Steering Springs can now be installed, connecting the tailwheel Steering Arm to the Rudder Horn. Use needle nose pliers to make a loop in one end of the spring to hook into the outermost hole on the back edge of the rudder horn. With the rudder and tailwheel both in neutral position, apply a small amount of tension to the spring and use the pliers to make a 90 deg. bend at the outermost hole in the tailwheel steering arm. Insert the wire into the steering arm and make another 90 deg. bend back toward the center of the spring, forming a loop. Do the same for the other spring. Do not over stretch the springs when doing this. A little bit of tension is all you need. Turn on your radio system to check the movement of the rudder and tailwheel. If there is binding, correct it. The springs should center the tailwheel to the rudder when it is at neutral.

Fuel Tank

A 12 oz. Du-Bro fuel tank (not supplied) is recommended for the Cub. Assemble the fuel tank per the tank manufacturer's instructions, with one vent line and one feed line. Attach a length of heat-proof silicone fuel line (not supplied) to the tank tubes. Label the fuel lines "carb" and "vent", so you can tell them apart after the tank is place. Working through the cabin door, insert the fuel lines through the firewall as you slide the tank in place. Use scrap balsa or a couple dabs of silicone caulk to secure the tank to some part of the fuselage structure, so the tank can't move around in flight.

A REMOTE FUELING VALVE IS HIGHLY RECOMMENDED! With a scale cowling, it is sometimes difficult to reach the fuel lines for fueling and de-fueling the airplane at the field. Du-Bro makes a very handy Kwik-Fill Fueling Valve (part DUB334, for glow fuel only) that solves this problem in the easiest way. We highly recommend that you purchase a Du-Bro 334 Fueling Valve, or equivalent, and install it in your Cub.

In this Cub kit we have included a formed Aluminum Fueler Mount (shaped like an "L") that we use to mount the Du-Bro Fueling Valve to the firewall. It has a 3/8" dia. hole on one leg and two mounting holes in the other.



Determine a good location for the fueling valve and mark the location of the mounting holes. Drill pilot holes with a 3/64" bit, and mount the bracket with two #2 x3/8" Sheet Metal Screws. Mount the Du-Bro Fueling Valve in the 3/8" hole and then, follow the instructions on the Du-Bro package to hook up the fuel lines properly.

Throttle Pushrod

The throttle pushrod supplied in this Cub kit is the "flex-cable" variety, consisting of a 1/16" od steel cable running inside a nylon tubing sleeve. At each end of the pushrod cable is an adjustable "pushrod connector".

197. With the engine and fuel tank in place, slide the .130" od Nylon Tube for the throttle pushrod sleeve through the hole in the firewall. Route it along the side of the tank back to the throttle servo. You will need to make and install a support for the servo end of the sleeve out of scrap balsa or plywood. The support should be permanently glued to the model structure and it should aim the sleeve right at the throttle servo control arm. Glue the sleeve, with the end of the sleeve about 1" short of the servo arm.
198. At the front, glue the throttle pushrod sleeve to the firewall. Cut the sleeve about 1" short of the carb throttle arm.
199. Install the pushrod connectors on each end of the pushrod, and adjust the length of the pushrod to get full throttle movement.

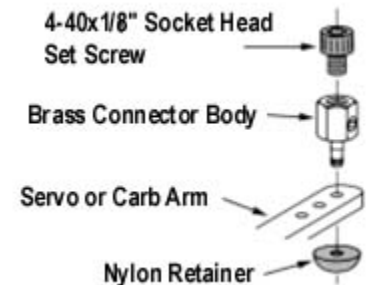

Self-Adhesive Decals

The decals provided in this kit are made of adhesive-backed mylar, they are NOT water activated transfers. These decals are not diecut and need to be cut from their sheets with a sharp #11 blade or good pair of scissors. Trim as close to the image as possible.

Putting sticky-back decals on a model can be tricky! Especially medium to large size ones like those in this kit. If you don't do it right, you will end up with unsightly air bubbles trapped underneath the decal. Here's a method that eliminates that problem entirely and makes the job easy and fun.

You will need a "soapy water" mixture (water mixed with a very small amount of dish soap, or SIG Pure Magic Model Airplane Cleaner, or Fantastic®, Windex®, or 409® type cleaners all work good). You will also need a supple squeegee (the SIG 4" Epoxy Spreader SIGSH678 is perfect for this job), a couple clean soft cloths (old tee shirts are great), a good straight edge, a ruler, and a hobby knife with sharp #11 blades. We also suggest that you have some trim tape handy for making temporary guidelines (1/8" width or so is perfect) for help in aligning the decals.

First, spray the surface of the model where the decal is to be placed with a soapy water mixture. Then, peel the backing sheet completely off the decal, being careful not to let the sticky side double over and adhere to itself. Place the decal onto the wet surface of the model. Do not push down! The soapy water solution will keep the decal from actually sticking to the model until you have had time to shift it around into exact position. Once you have it in position, squeegee the excess soapy water out from under the decal. Mop up the water with a dry cloth. Squeegee repeatedly to get as much of the water out from under the decal as possible. After setting overnight, the decal will be solidly adhered to the surface.

Instrument Panel

A full-color printed paper Piper J-3 Cub instrument panel is included in this kit. Simply cut it out with a sharp scissors and use spray cement to glue it in place.

Balance Your Cub

Completely assemble the model, including propeller and spinner nut. Do not leave anything off the airplane that will be on it in flight. DO NOT fill the fuel tank for balancing purposes.

RECOMMENDED BALANCE POINT 3-1/2" back from the leading edge of the wing

IMPORTANT NOTE: Balanced means the airplane sets level when supported at the desired balance point, not slightly nose down or nose up.

FLYING

The Cub is not difficult to manage on the ground or in the air. However, being a taildragger, there are some differences you should be aware of between flying the Cub and flying most trainer or pattern type models. It handles more like a full size airplane than most models.



When taxiing the Cub on the ground, be prepared to use the elevators and ailerons in addition to the obvious rudder steering and throttle inputs. When the winds are calm, hold full up elevator while taxiing in any direction, to keep the tailwheel in firm contact with the ground for effective steering. Leave the ailerons in neutral, steer with the rudder, and control ground speed with the throttle. Under windy conditions, also hold up elevator when taxiing either upwind or crosswind. When going downwind, put the elevators in neutral or partly down to keep the wind from getting under the tail and flipping the Cub on its nose. Aileron deflection may also be needed while taxiing crosswind to keep the upwind wing from lifting off the ground.

Line up the Cub on the middle of the runway for takeoff. If you haven't had much taildragger time, it's best to stand directly behind the model so you can easily see any changes in heading that will need to be corrected during the takeoff run. Leave the elevator in neutral. Advance the throttle smoothly to full open. As the tail lifts up on its own, the Cub will try to drift to the left from the torque. Feed in right rudder as needed to keep the model straight. When you have flying speed, pull back slightly on the elevator stick for a gentle liftoff. During the takeoff run, do not overcontrol the rudder, which will start the Cub swerving from side to side. If you find yourself in that situation, pull back on the throttle back to low and get the model stopped. Taxi back and start over. Never try to hurry the model off the ground by pulling full up elevator just because the model isn't going straight! The damage from a premature snap roll on takeoff would be much more severe than anything that could happen on the ground.

In the air, you'll find the Cub stable, yet responsive. With practice, it is capable of doing basic maneuvers such as inside loops, barrel rolls, and spins. After you've had a chance to get the model all trimmed out, practice making your turns by coordinating rudder commands in with the ailerons, as is done in a full size airplane. Proper coordination of the rudder with the ailerons will make for a smoother, more graceful turn.

Landing the Cub straight into the wind or under calm conditions is pretty much like landing any other model. Be careful not to let the nose get too high during banks with power off. Either wheel landings or three-point landings can be made with the Cub. Just remember to fly the model even after it touches down. Once the tailwheel gets back on the ground, you'll have good steering and the model will slow down fast.

If there is any amount of crosswind, even quartering, landing the Cub becomes a little trickier. Proper coordination of the ailerons and the rudder is again needed to maintain your heading. After the model is turned onto final approach, use the rudder to hold the model on a straight heading with the runway and feed in aileron to correct any drifting to the side. For example, with a crosswind from the left, you'll need to hold a little right rudder to correct any "crab" angle and put in left aileron to keep the model from drifting to the right.

If all these hints make it sound as if the Cub is difficult to fly, it really isn't! The Cub can be safely flown by anyone who is capable of handling a multi-channel model. Once you get a few Cub flights under your belt, you'll find rudder/aileron coordinated flying becoming second nature and you'll be a better pilot with all types of models.

GOOD FLYING!

WARNING! THIS IS NOT A TOY!

Flying machines of any form, either model-size or full-size, are not toys! Because of the speeds that airplanes must achieve in order to fly, they are capable of causing serious bodily harm and property damage if they crash. IT IS YOUR RESPONSIBILITY AND YOURS ALONE to assemble this model airplane correctly according to the plans and instructions, to ground test the finished model before each flight to make sure it is completely airworthy, and to always fly your model in a safe location and in a safe manner. The first test flights should only be made by an experienced R/C flyer, familiar with high performance R/C aircraft.

The governing body for radio-control model airplanes in the United States is the ACADEMY OF MODEL AERONAUTICS, commonly called the AMA. The AMA SAFETY CODE provides guidelines for the safe operation of R/C model airplanes. While AMA membership is not necessarily mandatory, it is required by most R/C flying clubs in the U.S. and provides you with important liability insurance in case your R/C model should ever cause serious property damage or personal injury to someone else. For more information, contact

ACADEMY OF MODEL AERONAUTICS
5151 East Memorial Drive
Muncie, IN 47302
Telephone: (317) 287-1256

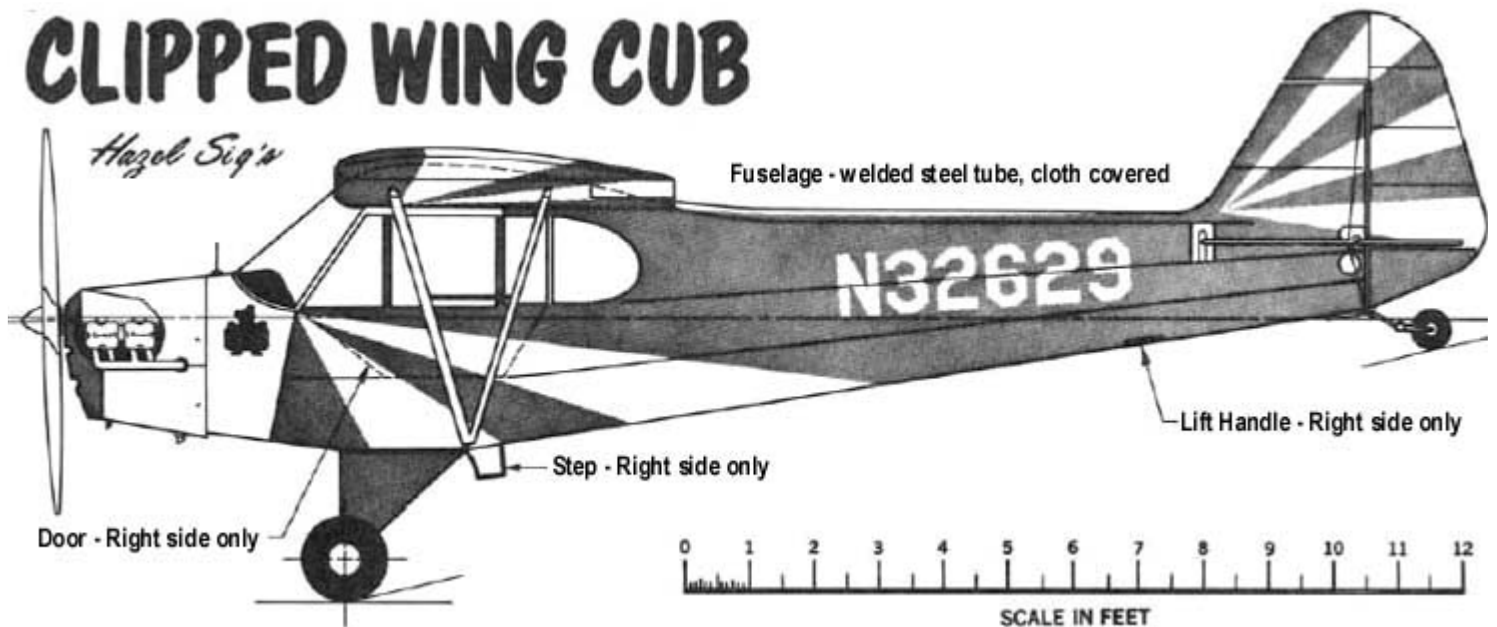

Hazel Sig's

CLIPPED WING CUB

Manufactured in 1941 as a standard Piper model J3C-65 Cub
Rebuilt in 1969 including reed Clipped Wing Conversion

Tail surfaces -
Welded steel tube,
cloth covered

| | | | |
|-----------------------------|------------|-----------------|------------|
| WINGSPAN: | 28' 5 1/2" | LENGTH: | 22' 4 1/2" |
| WING CHORD: | 5' 3" | HEIGHT: | 6' 8" |
| CONTINENTAL A65-8 (75 H.P.) | | CRUISING SPEED: | 90 M.P.H. |

Color Key

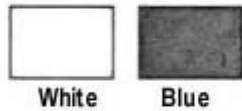

2 1/2 Rib Bays (approx. 3 1/2") were removed
from the root of each wing panel

Standard J-3 Wing
35' 2 1/2"

Fuel Cap

Wing - Strut braced, two spar, aluminum leading edge,
cloth covered, USA 35-B airfoil

71" Aluminum Propeller

Streamlined Shock Covers



SCALE IN FEET

WING-STRUT BRACED. TWO SPAR ALUMINUM LEADING EDGE,
CLOTH COVERED, USA 35-B AIRFOIL.

72" WOOD SENSENICH PROPELLER

PIPER J-3 CUB

| | |
|-----------------------------|---------------------------|
| WINGSPAN: 35' 2 1/2" | TOP SPEED: 87 M.P.H. |
| LENGTH: 22' 7 1/2" | CRUISING SPEED: 75 M.P.H. |
| HEIGHT: 6' 8" | LANDING SPEED: 38 M.P.H. |
| WING CHORD: 5' 3" | EMPTY WEIGHT: 680 LBS. |
| CONTINENTAL A65-8 (65 H.P.) | GROSS WEIGHT: 1220 LBS. |

FUEL CAP



SCALE IN FEET



PIPER J-3 CUB

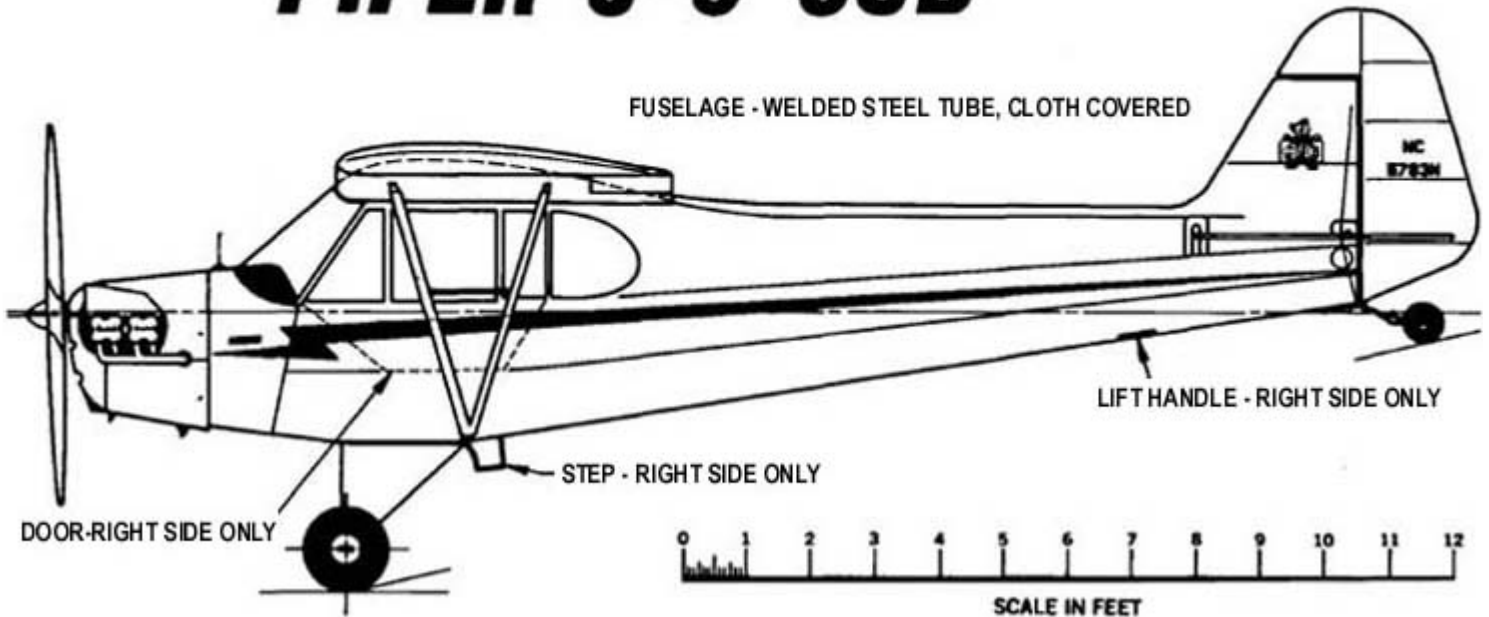

Customer Service

SIG MFG. CO. is totally committed to your success in both building and flying the ANNIVERSARY CUB design. Should you encounter any problem building this kit, or discover any missing or damaged parts, please feel free to contact us by mail or telephone.

SIG MFG. CO., INC.
401-7 South Front Street
Montezuma, IA 50171-0520

SIG MODELER S ORDERLINE: (to order parts)

1-800-247-5008

SIG MODELER S HOTLINE (for technical support)

1-641-623-0215

SIG WEB SITE

www.sigmfg.com

© Copyright SIG Mfg. Co., Inc.

SIG MFG. CO., INC.....Montezuma, Iowa 50171-0520

LIMIT OF LIABILITY: The craftsmanship, attention to detail and actions of the builder/flyer of this model airplane kit will ultimately determine the airworthiness, flight performance and safety of the finished model. SIG MFG. CO's obligation shall be to replace those parts of the kit proven to be defective or missing. The user shall determine the suitability of the product for his or her intended use and shall assume all risk and liability in connection therewith.