



1909



Antoinette

ASSEMBLY MANUAL

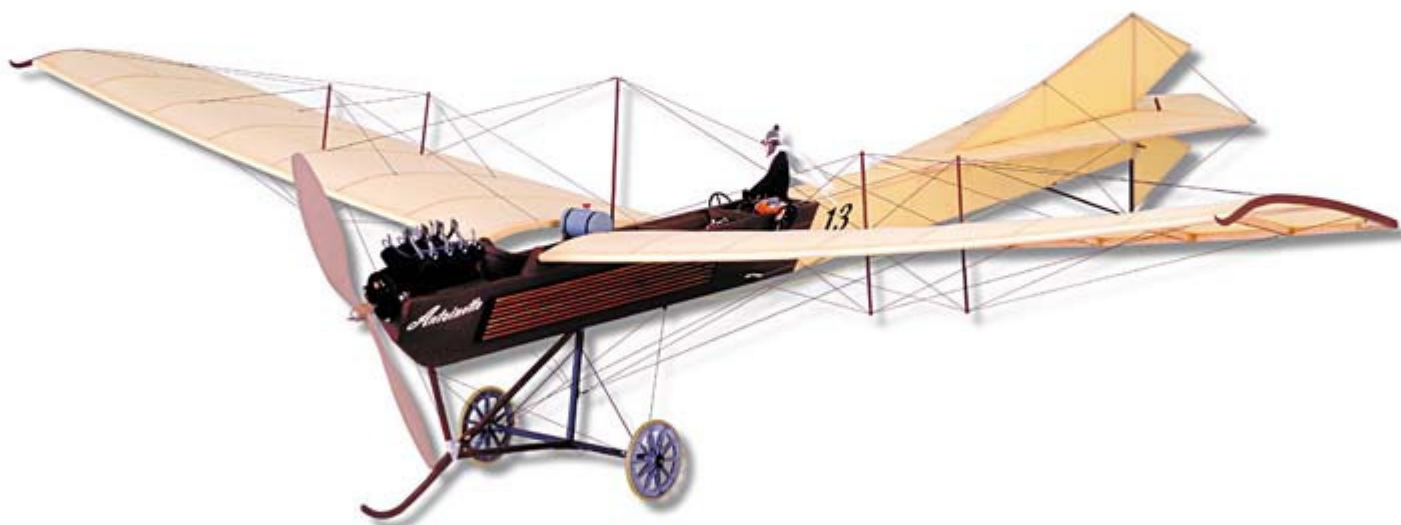

SIG MANUFACTURING COMPANY, INC.



Introduction

The Antoinette is considered by many as the most esthetically beautiful airplane of the early pioneering era of aviation. Designed by Leon Levasseur, a renowned boat builder and engineer, the Antoinette possessed many features and innovations that were far ahead of its time.

The story begins in 1903 when Levasseur, financed by a gentleman named Jules Gastambide, designed and built a super light engine specifically for the new sport of motor boating. Named for Gastambide's daughter, Antoinette, the engine was a large success and by 1904, it was powering winning powerboat racers all over Europe.

By 1906, in response to the rapidly growing interest in aviation, a new company was formed for the commercial development and production of the Antoinette engine for use in aircraft. Gastambide was the president, Louis Bleriot vice-president, and Levasseur was the technical director. The Antoinette aircraft engine was innovative and relatively powerful. It employed direct fuel injection and evaporative steam cooling.

It was a V-8 in configuration and was made to be very light, at 110 lbs. Rated at 50 hp, this engine produced an admirable power-to-weight ratio of 2.2 lbs./hp. For perspective, this power-to-weight ratio was not to be generally exceeded for the next 25 years! If the engine had any faults, it was primarily the fuel injection system. Even the tiniest speck of dirt would foul the injectors causing the engine to stop. Nonetheless, the engine was a commercial success and was used by many early aviation pioneers in their designs.

Eventually, Levavasseur was asked by the owners of the company to design an aeroplane. His first two efforts were not very successful. Levavasseur's third aeroplane met with limited success in that it was the first monoplane in the world to carry a passenger aloft and make a complete circuit of the field before landing. It was also one of the first aeroplanes to use dihedral in the wings, a concept which was not widely accepted at that time. Subsequent versions of this airplane featured beautifully paneled wood fuselages with "boat prow" noses, sail-like tail groups, and even a central rigging "mast".

The Antoinette IV was flown in early 1909 and was immediately at the forefront of aviation performance. Flown by French aviator Hubert Latham, the Antoinette IV narrowly missed beating Louis Bleriot in the first flight across the English Channel. Subsequent versions of the Antoinette, variously powered by V-8, V-12, and even V-16 engines, were seemingly everywhere in competitions and record attempts.

The SIG Antoinette is based on one of the more famous versions, the Model VII. The signature top and bottom rudders, triangular elevators, and boat prow fuselage are all faithfully incorporated into this unique piece of aviation history. The model itself is remarkably stable, easy to fly, and really looks the part in the air! The airplane is capable of extremely slow flight and is likely, very close to scale speeds. When built to these instructions and properly detailed, the SIG indoor R/C Antoinette is very believable - on the ground or in the air.

Building your Antoinette has been made easy with the supplied laser-cut parts. The included profile pilot has been used in all of our Antoinette models, giving the airplane a more realistic look as well as a scale size perspective. Detailing your Antoinette is covered fully in these instructions. The scale-like plastic V-8 engine is easy to assemble and is a nice addition to the model. The elastic rigging lines and rigging swages likewise give the finished airplane a wonderful look. Between flying sessions, you may enjoy displaying this intriguing and historically significant model in your workshop, office, or den - it's a real attention grabber!

This kit is not intended for beginning modelers. However, most intermediate modelers with average building skills will find the Antoinette easy to build and fly. These instructions assume that you are aware of the importance of using the correct type and amount of glue, how to make proper wood joints, and how to fly R/C models.

Motors And Propellers

We've chosen the well-proven GWS "R/C Indoor Power System" motors and gear drives to power the SIG Antoinette (note that Maxx Products also markets these exact same power units under their "MPI" name). These motor and gear drive systems are very easy to use, widely available, very inexpensive, and are of good quality. These systems are currently available in eight different gear ratios, capable of swinging propellers from 6" diameter all the way up to 12" diameter. GWS also produces a good selection of propellers to fit all of their gear drive systems. During the development of the Antoinette, we experimented with different gear ratios and propellers.

We found that a very good combination for this airplane was the GWS "DX-B" system (same as Maxx Products "EPU-7") which has a 7:1 gear ratio, along with the GWS 10 x 5 propeller. With a 7-cell 350mAh Ni-Cad battery pack (Sanyo P/N N-350AAC), this combination has provided good power margins, scale-like speeds along with very good flight duration.

Hubert Latham turns his Antoinette around the pylon in a speed event in 1909 at a blistering 48 mph. That same year, Latham set world records for endurance (1 hour 7 minutes) and altitude (512 feet) with his Antoinette.



Radio Equipment, Speed Controller, Battery Pack, And Connectors

One of the very reasons that indoor models such as the Antoinette are now possible is the fairly recent availability of good quality, reasonably priced light-weight micro receivers, servos, and speed controllers (ESC's). Up to this time, such equipment was only available from small, highly specialized sources at relatively high prices.

Here are the airborne system components we've used in the Antoinette.

Item	Weight
Maxx Products (MPI) #MX-6800 Pico 4-Ch Micro Receiver, w/crystal	8 grams
Maxx Products (MPI) #MX-30 Pico Servos	7 grams each
Maxx Products (MPI) #MX-9104 Micro ESC (Electronic Speed Control)	1 gram
7-cell 350mAh Ni-Cd (nicad) Battery Pack	95 grams
7-cell 500 mAh NiMH (nickel metal hydride) Battery Pack	96 grams



These are the components that are shown in this manual and on the plans. We did not use an On/Off switch in this airplane because of weight considerations. The battery is simply plugged and unplugged from the ESC before and after each flight. Different brands of receivers, servos, and ESC's may be usable with this design, provided they are the same weight and size or lighter. For obvious reasons, standard size radio components cannot be used with the Antoinette.

A 7-cell 350mAh Ni-Cad battery pack is used in the Antoinette to provide good flight duration. With throttle management, this battery pack will keep the Antoinette flying for anywhere from 8 to 12 minutes. We've also used 7-cell 500 mAh NiMH (Nickel Metal Hydride) battery packs with good results. In general, the difference between this type of cell and the 350 mAh NiCad cell is that the NiMH pack seems to deliver a little less power with some incremental increase in duration. Both types of cells weigh the same, so they are both usable. Last, the battery pack should be configured in the "hump" shape - four cells on the bottom, three cells on top. This layout offers the most mass in the least amount of space and this is very helpful when making small changes in the C.G. location, if needed.

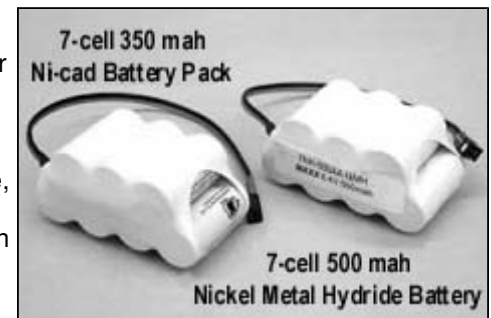

For maximum flight performance, indoor R/C models require attention to the weight of everything they must carry aloft, including connectors. We used and liked the small 2-prong Dean's connectors for connecting the battery pack to the ESC. Recently, Cloud 9 Micro R/C announced the availability of their new micro connectors. We've seen and used these and can recommend them for use with the Antoinette. There are many other connectors available on the market. Be sure to choose your connectors with weight, size, and efficiency considerations in mind.

Last, our radio systems include excellent transmitters, providing us with features such as servo throw adjustments (EPA), servo reversing, servo sub-trim adjustments, etc. Our trusty Airtronics® RD-6000 Sport transmitters and the equivalent HiTec units have taken care of all these needs.

Required Tools

A selection of glues

- SIG Thin CA
- SIG Medium or Thick CA
- SIG Thin CA Applicator Tips
- SIG Kwik-Shot CA Accelerator
- Heat-Activated Covering Adhesive, such as SIG Stix-It or Solarfilm Balsaloc.

Assorted drill bits, including

- .031" (1/32" or # 68)
- .046" (3/64" or # 56)
- .063" (1/16" or # 52)
- .078" (5/64" or # 47)
- .093" (3/32" or # 42)
- .109" (7/64" or # 35)

A selection of hand tools, such as

- Regular size and miniature screwdrivers
- Regular size and miniature pliers (flat nose, needle nose, round nose)
- Tweezers and/or small hemostats
- Hobby knife with sharp #11 blades
- Sandpaper - assorted grits
- Modeler's "T" pins
- Power drill and hand "pin vise" (for small diameter drill bits)

Paint

Since fuel proofing is not an issue with electric powered airplanes, the only reason to paint any part of the Antoinette is to improve the scale appearance of the model. And because light weight is so important in an indoor model, we've tried to keep the painting on the Antoinette to a minimum. Too much paint, or the wrong kind of paint, can add unnecessary weight in a hurry.

We suggest:

- Painting the front of the fuselage, the landing gear struts, and the wing tip skids brown to look like varnished wood. Do not use thick, heavy paints like epoxy or enamel on these large areas of the model. We prefer thinned SIG Supercoat Dope or "waterbased acrylic craft paint" (see note below). One coat is usually all that is necessary. A completely filled glossy paint job is not necessary or desirable, and it's too heavy for this type of model. One coat usually achieves the "old time" look we are after.
** Water-Based Acrylic Craft Paint: These very inexpensive paints are sold in the craft departments of stores such as Wal-Mart, K-Mart, and similar outlets. They seem to be manufactured under many different brand names, such as Delta Ceramcoat and Apple Barrel Colors. They are available in a huge variety of colors. We found that thinning these paints with equal amounts of water produced nice results, when either brushed or sprayed, with very little weight build-up. Clean-up is also easy, using just warm water.*
- We've tried a variety of colors for the balsa wheels on our prototype Antoinette models: gray to simulate steel wheels, brown for wood wheels, or black like the original Antoinette in the Paris Musee d'Air museum. It's your choice and a matter of personal preference.
- The amber colored surgical tubing that is provided for the tires can be easily dyed black with regular household variety Rit Dye. That looks good with gray or brown wheels. The Antoinette in the Paris museum has gray tires on black wheels.
- The dummy engine, dummy gas tank, and other small scale details were also painted to improve their scale appearance. These parts were painted with Testors Model Master paints, using the spray can products whenever possible. This is enamel paint, primarily marketed for plastic models, but it is thin enough that it can be used on our small parts without appreciable weight build-up. The engine crankcase was sprayed Steel color. The cylinders are Copper, just like the real Antoinette engine had. The exhaust pipes look good painted with Exhaust Buffing Metalizer. The dummy gas tank looks great painted Copper, just like on the full-scale Antoinette.

COMPLETE KIT PARTS LIST

COMPLETE KIT PARTS LIST							
Balsa Sticks & Sheets							
1	1/16"x1/4"x24" Balsa Sticks; for W1 Rib Stiffeners	3	1/8"x1/8"x43" Balsa Sticks; for Fuselage Longerons	7	1/8"x1/8"x36" Balsa Sticks; for Fuselage, Stab, Elevator, Fin, Rudder, Wing Tip Braces	4	1/4" dia. x 30" Balsa Dowels; for Wing L.E., Wing T.E.
1	1/4" dia. x 6-3/4" Balsa Dowel; for L.G. Spreader Bar	2	1/32"x3"x24" Balsa Sheet; for Fuselage Side Sheeting				
Laser-Cut Balsa							
1	1/16" thick Sheet #1; F2, F3, F4, F5, F6, F7, F8, F9, F10, FD1	1	1/16" thick Sheet #2; F11, F12, F13, LG2, LG3, LG4, WHL	2	1/8" thick Sheet #3; W1, W2, W3, W4, W5, W6, W7, W8, WG1, WG2, WG3, WG4, CHG, WHB	1	1/8" thick Sheet #4; S1, S2, KEEL, BTM, RXM
1	1/4" thick Sheet #5; FDB, RDB	1	1/32" thick Sheet #6; WSP, DUMMY ENGINE BASE				
Laser-Cut Plywood							
1	1/8" thick Sheet #7; F1, WM	1	1/32" thick Sheet #8; LG1, LG5, LG6, WTS, WSF, WHC, WRT, CHN, CONTROL WHEELS	1	1/16" thick Sheet #9; MOTOR MOUNT		
Hardwood							
1	1/4" dia. x6-1/8" Birch Dowel; for Main Gear Post	4	10" Bamboo Sticks; for Tail Skid, Center Rigging Post, Wing Rigging Posts	1	1/8"x1/4"x3" Basswood Stick; for Servo Mounts		
Wire Parts							
1	.020" dia. x12" Straight Wire; for Rigging Hooks	2	.046" dia. x1-1/2" Straight Wire; for Axles	2	.046" dia. Formed Landing Gear Brace Wires		
Hardware							
3	#2 x1/4" Sheet Metal Screws; for motor attachment	1	.090 x1/8" Round Brass Machine Screw; for pilot	1	.090 Brass Hex Nut; for pilot	2	.090 Brass Washers; for pilot
Miscellaneous Parts							
1	Molded ABS Plastic Scale Dummy Engine Crankcase	2	Molded ABS Plastic Scale Dummy Engine Cylinders	1	Sig Easy Hinge	32	1/16" od x1/4" Aluminum Tubes; for Wing Rigging Points and Swage Tubes
4	1/4" id x1-5/16" Aluminum Tubes; for Wing Mount Tubes	1	10 ft. Monofilament Fishing Line; for pull-pull lines	1	8 yds. Elastic Thread; for rigging wires	1	2 ft. Dacron Thread
1	20" Surgical Rubber Tubing; for Tires	1	19-1/2"x90" Covering Material, color: antique	1	3/4"x3" long Velcro®	1	Pilot Sheet
1	Decal Sheet	1	Full-Size Plan	1	Assembly Manual		

Sheet #1 1/16" Balsa

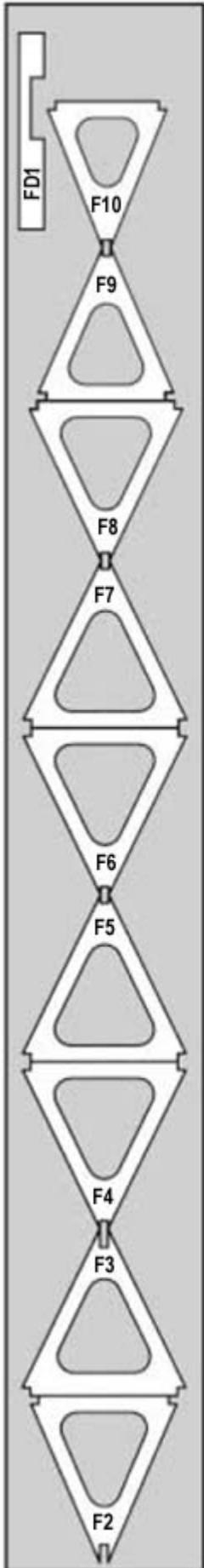

Sheet #2 1/16" Balsa

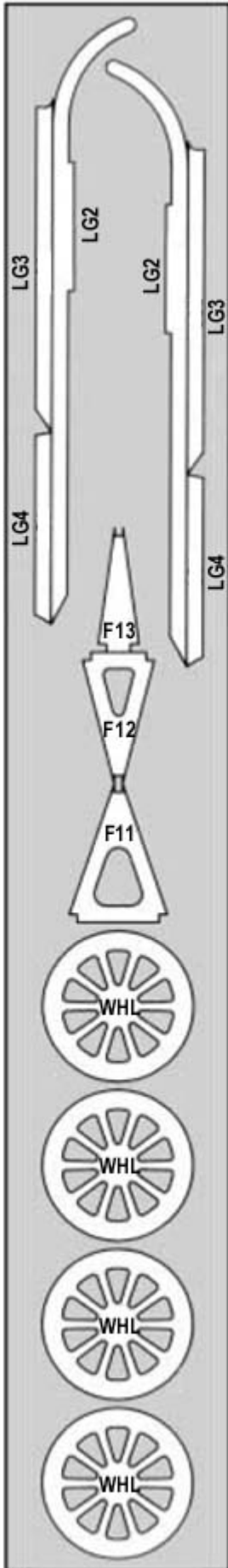

Sheet #3 1/8" Balsa

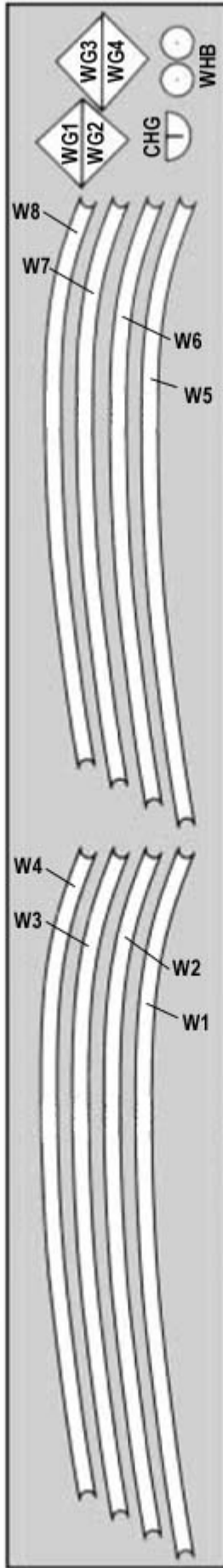

KEY TO LASER-CUT PARTS

Use a pencil to mark each of the laser-cut parts according to these diagrams.

When it is time to remove a part from the sheet, use a sharp #11 hobby knife to slice through the small bridges that hold the part in the sheet. Do not try to push the parts out of the sheet without first cutting through the bridges, or you may end up with a lot of broken parts.

Sheet #5 1/4" Balsa



Sheet #7 1/8" Plywood

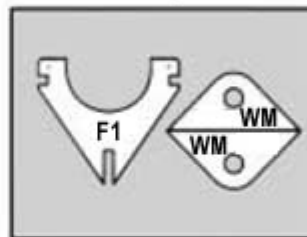

Sheet #6 1/32" Balsa

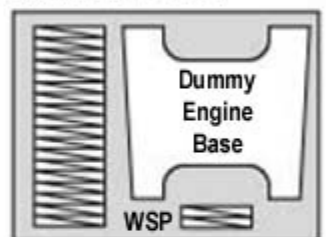

Sheet #8 1/32" Plywood

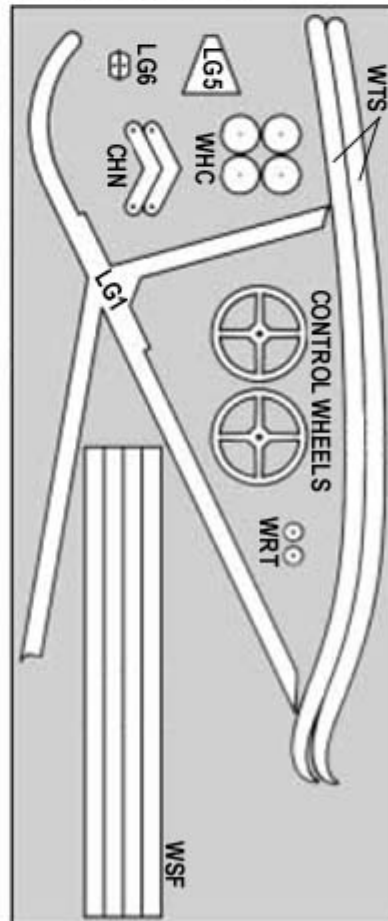

Motor Mount
1/16" Plywood



Sheet #4 1/8" Balsa

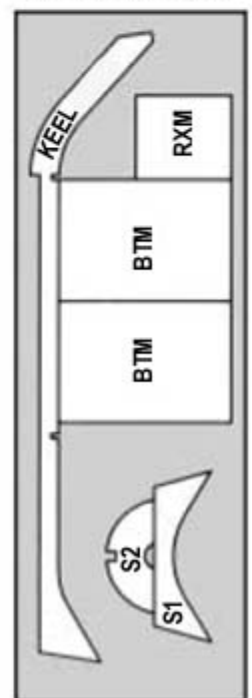

FUSELAGE CONSTRUCTION

1. The basic framework of the fuselage will be built upside down on the plan. Pin the FUSELAGE TOP FRAME PLAN to your building board and cover with wax paper or plastic wrap for protection. Locate the plan on the building board so that former F1 is just past the end of the board (the top of F1 has two "tabs" that must hang over the edge of the board when F1 is installed later).
2. Pin two 1/8" sq. x43" balsa sticks directly over the plan for the Top Longerons. Bend the longerons to follow the plan exactly from former F2 all the way back to the tail end. Don't worry about the area forward of F2 at this time - it will be pulled together later when we install former F1.

Note: You will have to taper the inside edges of both longerons slightly at the tail end, as shown on the plan.

3. Cut to length and pin in place all of the 1/8" sq. balsa crosspieces shown on the FUSELAGE TOP FRAME PLAN. Tack glue them in place with a small drop of Thin CA at each end.

Note: Cut these cross-braces from the leftover 1/8" sq. from step 2 and from new 36" long stock. Do not cut them from the last 1/8" sq. x43" stick, which will be needed for step 6.

Basic Rule of Model Building: Cut the longest pieces of 1/8" sq. balsa first, then the shorter pieces, in order to make the most efficient use of the stock 36" long sticks. This is good advice for this step and throughout the entire construction of this airplane.

4. Glue formers F2, F3, F4, F5, F6, F7, F8, F9, F10, F11, F12, and F13 in place. Make sure all these formers are glued in perpendicular (90 deg.) to the building board. Do not install former F1 at this time, or the 1/8" sq. balsa doublers that go between F1 and F2. We'll add them shortly. Leave the top frame assembly pinned to the plan even after the glue is dry.

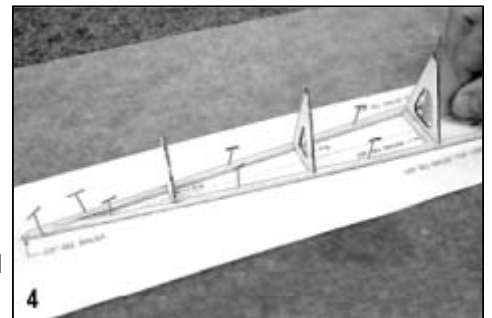

5. Glue the balsa Keel into the notches in formers F2 and F3.
6. Cut the last 1/8" sq. x43" balsa stick to 17" long to make the forward portion of the Bottom Longeron. That should be real close to the length you need to go from the notch in former F2 back to former F7. Trial fit the piece in the notches of the formers. Final trim the length, if necessary, so that the longeron ends halfway in the notch of F7. Glue in place.
7. Cut the remainder of the 43" long stick from the previous step to 22" long. This is the rear portion of the Bottom Longeron. Glue it in the notches of all the rear formers F7 through F13. Let the excess length hang over past the tail end of the fuselage.

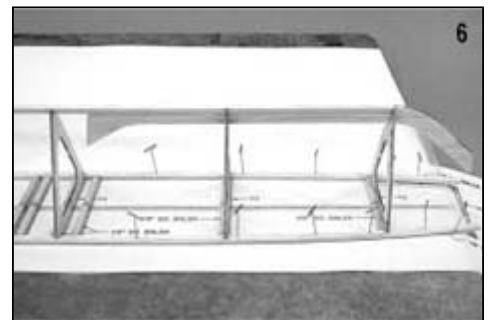

8. Use a 90 deg. triangle to mark and cut the tail end of the Bottom Longeron even with the ends of the Top Longerons.
9. Cut a piece of 1/8" sq. balsa for the tail post. Note that the bottom end must be cut at an angle. Glue the tail post in place to the fuselage framework.

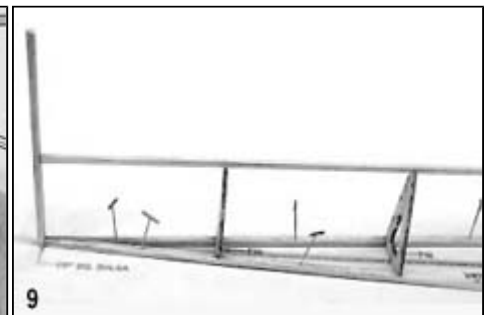
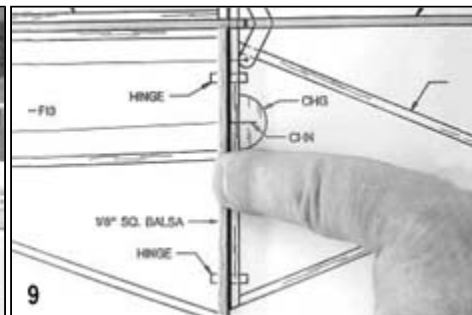
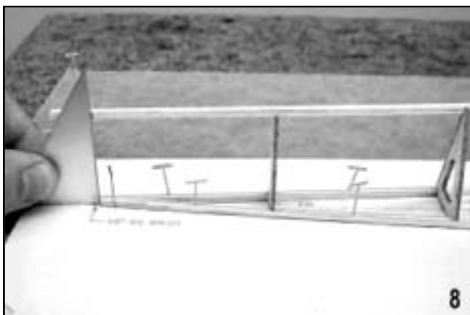

10a. Even though we're not going to glue it on right now, let's make the Tail Skid.
Take one of the 10" pieces of bamboo provided and put a pencil mark at 7" and 8" from one end. The 1" area between these two marks needs to be bent to form the curved bottom of the tail skid, as shown on the plan.

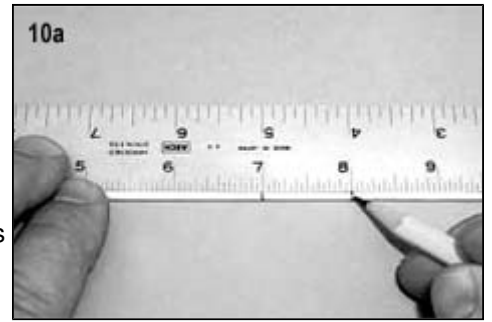

b. There are a lot of different ways to bend wood, but for this application we've found that the easiest method is simply to do a "controlled break" of the area we want formed. In other words, we simply bend the bamboo slowly until it just starts to break. Start with the tip of your thumb near one end of the 1" marked area. Bend the stick over your thumb until you feel it start to break. Stop, move your thumb about 1/4" or so further along in the area you want formed, and then bend again. Continue moving along in small increments in the area you want formed, bending it to the point of almost breaking, until you have the shape you want. Don't worry if a few strands of bamboo start to get loose on the outside of the curve. Once you've got the shape you want, thoroughly soak the entire bent area of the bamboo stick with thin CA to re-strengthen it. When dry, sand off any rough spots. Cut off the unwanted portion of the bamboo stick at the 8" mark and sand the end round.

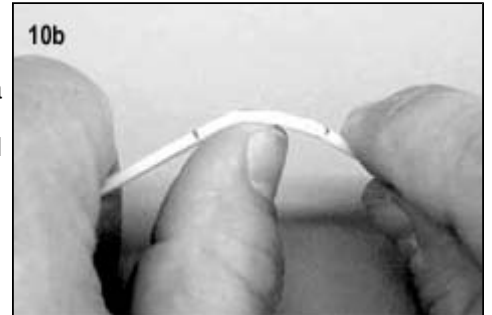

NOTE: Don't worry if the bend in your tail skid doesn't match the plan exactly. The tail skids on the full-scale Antoinettes were all a little different too.

c. Bevel off the top end of the Tail Skid to fit against the bottom of the fuselage, as shown on the plan. Then, trial fit the Tail Skid on the bottom of the fuselage. You could glue it on now, which would lend support to the rudder post, but we've found it's a lot easier to cover the rear of the fuselage without the Tail Skid in place. So set it aside for now, and try to be careful not to break off the rudder post.

11. Double check that the ends of the two 1/8" sq. balsa Top Longerons are cut off right at the front face of former F1 on the plan. Then, install former F1 at the front of the fuselage. The angle on the front of the Keel sets the proper "downthrust" angle for F1. Just make sure the ends of the Top Longerons and the front portion of the Keel are flush with the front face of F1, and that will set the proper angle.

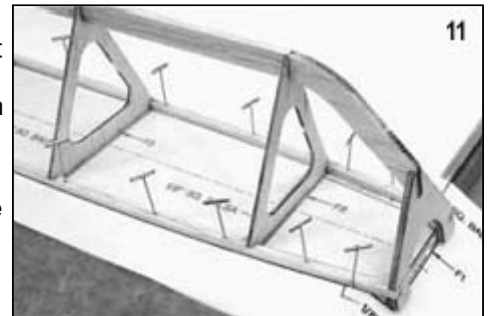

12. Inspect all the glue joints in the fuselage to this point, and apply more glue where needed. Let dry. Then unpin the fuselage assembly from the building board.

13. Using a small sanding block with 100-150 grit paper, bevel the front edge of the keel slightly in preparation for adding the fuselage side sheeting. You don't have to sand it to a sharp point, just take the edge off the corners of the keel to provide a good gluing surface for the sheeting.

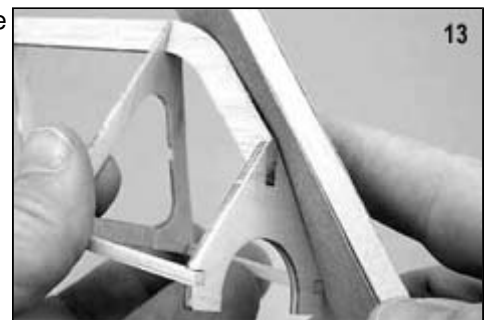

14. Two sheets of 1/32"x3"x24" balsa are provided for sheeting the sides of the fuselage from F1 back to F7. The best procedure is to lay one of the 1/32" balsa sheets on a piece of wax paper on your flat building board. Then lay the side of the fuselage down flat on the balsa sheet. As you hold the fuselage down flat against the balsa sheet, start tack gluing formers F7 thru F3 to the sheet. Also glue the top and bottom longerons. Let dry. Note: Don't glue the sheeting to F2 and F1 at this time. Wait until we get the sheeting put on the other side first.

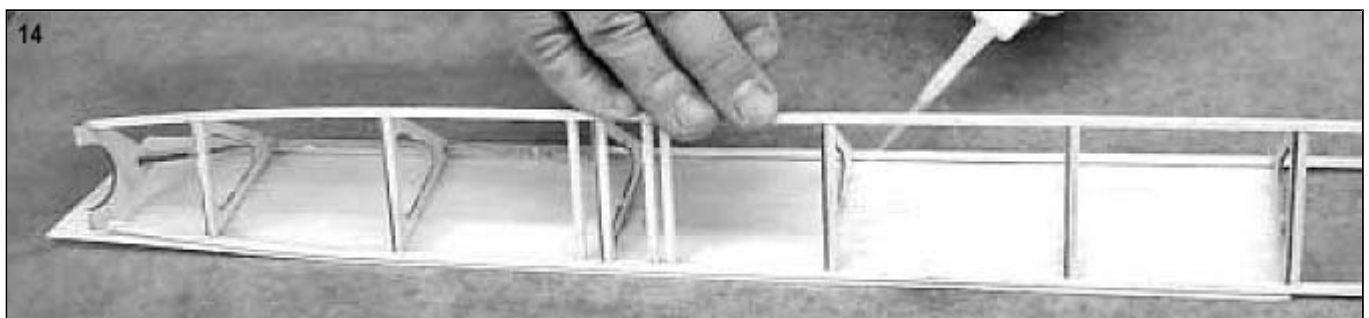

15. Now repeat the previous step to glue 1/32" balsa sheeting onto the other side of the fuselage. Let dry.
16. Start pulling the front of both side sheets together at F1. You will have to start trimming some of the excess off both sheets so they don't interfere with each other at the front. When you can hold both side sheets tight against F1, F2, and the keel, start working your way around to all the contact points, gluing the side sheets in place. Let dry.
17. Trim and sand all the edges of the side sheeting flush with the structure.
18. Cut four pieces of 1/32" scrap balsa x 1/8"x1/4". Glue them on the sides of the top and bottom longerons at the end of the side sheeting at F7. Taper them down to blend smoothly from the end of the sheeting into the longerons. This will make the covering material go on a lot smoother later.
19. Glue laser-cut balsa part FD1 in place inside the left side sheeting, between formers F6 and F7, as shown on the plan. Notch out the top longeron and side sheeting to match the notch in FD1.

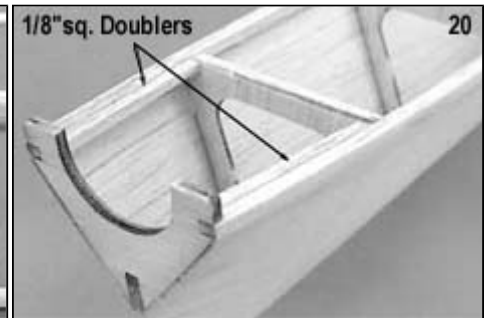
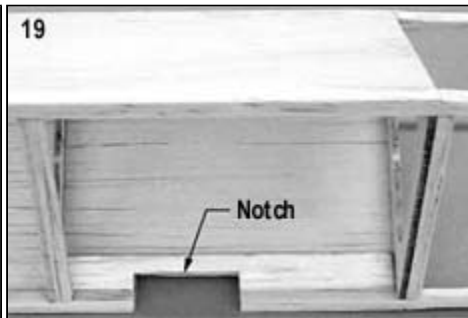
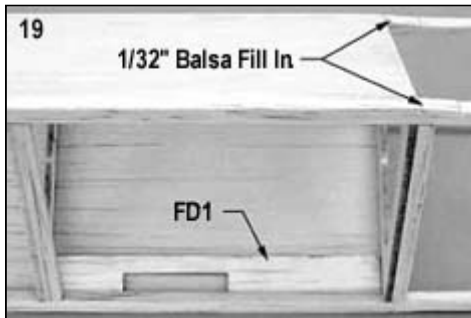

20. Cut to length and glue in place a 1/8" sq. balsa doubler on the inside of each top longeron between formers F1 & F2.
21. Glue the laser-cut rear dihedral brace RDB in place on the rear of former F6. Study the plans, including the F6 cross-section drawing, to make sure you understand exactly where it goes. It should sit perfectly between the fuselage side sheeting, right up against the back of F6.
22. Trial fit the laser-cut receiver mount RXM in place at the front of former F6. Bevel the outside edges of RXM slightly for a good fit against the fuselage side sheeting. Then, glue RXM in place.
23. Glue the laser-cut front dihedral brace FDB in place on the front of former F3. Study the plans, including the cross-section drawing, to make sure you understand exactly where it goes. The bottom edge of FDB must be flush with the top edge of the cutout in F3.
24. Trial fit the two laser-cut battery mounts BTM in place at the front and back of former F3. Bevel the outside edges of the mounts slightly for a good fit against the fuselage side sheeting. Then, glue them in place.

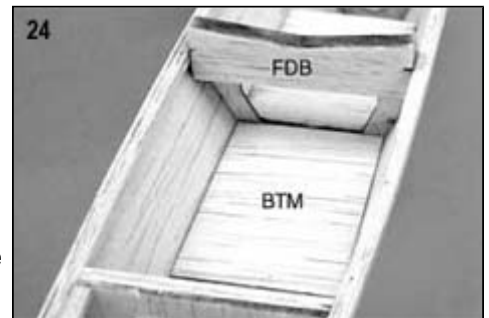
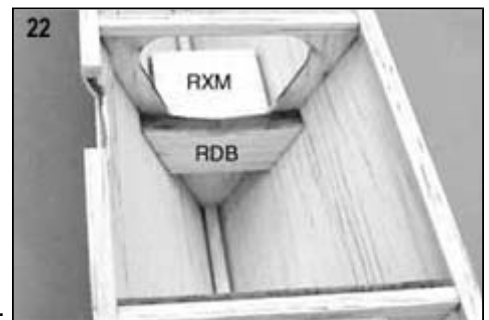

LANDING GEAR

25. Carefully remove the following parts for the wheels from the laser-cut sheets:
 - 4 - WHL wheels from sheet #2
 - 4 - WHB wheel hubs from sheet #3
 - 4 - WHC wheel hub caps from sheet #8
 - 40 - WSP wheel spokes from sheet #6
26. Use a #11 hobby knife to cut loose the "pie shaped" scrap pieces between each of the spokes of the WHL parts.

27. Notice that two of the WHL pieces will be laminated together to form the basic core of one wheel assembly. However before gluing them together, use a flat sanding block with medium grit sandpaper (100 to 200 grit), to bevel the outer edge of each WHL piece. Hold the sanding block at a 45 deg. angle. Bevel only one side of the piece.

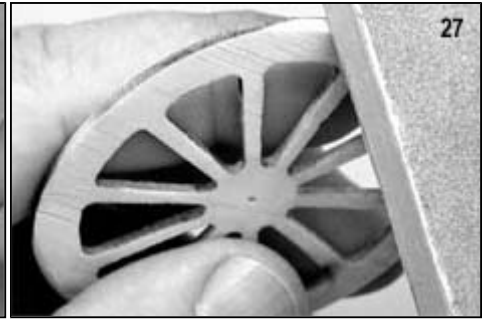
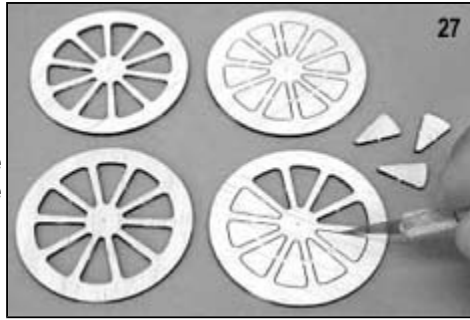

The purpose of the beveled edge is to provide a groove for the rubber tire to fit in after the WHL pieces are laminated together with their beveled edges facing each other.

28. It's important to work on a flat surface when laminating the WHL pieces together to insure that the finished wheel comes out flat, so it will roll straight and true with no wobble. First, lay a piece of waxed paper down on the flat surface. Next, lay a WHL piece down on the waxed paper with its beveled side up. Position a second WHL piece, beveled side down, on top of the first one. Rotate the top piece so its grain direction is 90 deg. to the grain direction of the bottom piece. This will provide maximum strength to the finished wheel.

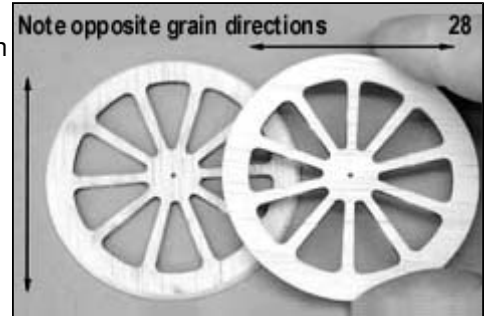

Carefully match up the spokes of the two WHL pieces exactly. When satisfied with the positioning, hold the parts flat while tack gluing them together with Thin CA glue at 3 or 4 spots around the outer edge. Put the drops of glue right in the beveled groove. Not too much, just enough to tack glue the WHL parts together.

After the glue dries, you can pick up the laminated part and continue gluing along the spokes and hub areas.

NOTE: It's best to use a fine applicator tip on your CA bottle during assembly of these wheels. In fact, a fine tip is preferred for the assembly of this entire kit.

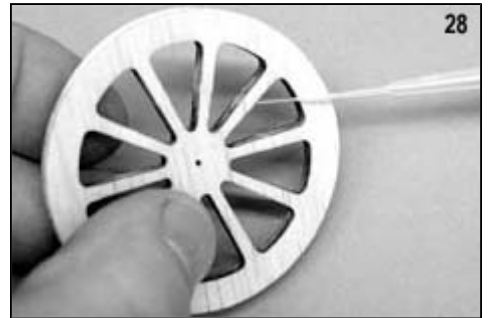

Building featherlight models like the Antoinette requires that we change our thinking a bit from the old habits we've used in building much heavier sport type models. With the small parts involved here, it's not desirable to flood a large area with a lot of glue. It's much better to get a little glue exactly where you need it, and a fine applicator tip does that for you.

29. Next, glue a 1/8" balsa WHB wheel hub and a 1/32" plywood WHC wheel hub cap onto each side of the wheel assembly. To insure that the center holes in all these parts are in correct alignment, it's best to first dry assemble all these parts onto a piece of .046" dia. x 1-1/2" music wire (provided for the axles) as shown. Then, while holding everything snugly together put a small drop of thin CA glue into each joint. Don't get any glue on the wire!

When dry, you can take the wire out and put a little more glue on the joints if they need it.

Note: After finishing the gluing, you may find that the center hole has become clogged with excess glue and the axle wire won't fit in the hole anymore. If so, drill out the hole with a .046" dia. (3/64" or #56) drill bit. Make sure the wheels will spin freely on the axle wires.

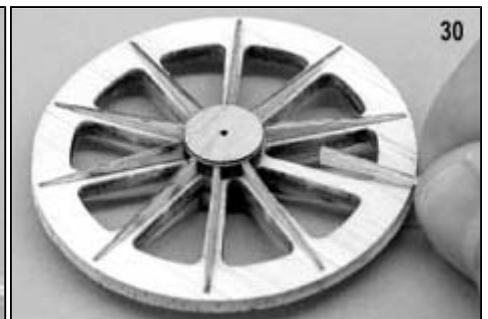
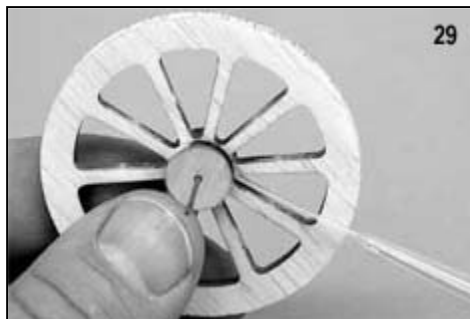

30. Glue the 1/32" balsa WSP wheel spokes in place on each side of the wheel. Again use thin CA and a fine applicator tip to keep the glue application to a minimum.

31. If you want to paint your wheels, do it now (refer to the section on "PAINT").

32. Complete the wheels by gluing a piece of surgical tubing around the outside to serve as the tire. Again, use thin CA and a fine applicator to keep the glue application under control. Start by tack gluing one end of the tubing in place in the groove with a single drop of glue. Now, work your way slowly around the perimeter of the wheel, lightly gluing the tubing in the groove as you go. It's not necessary to stretch the tubing as you put it on, simply make sure you are keeping it straight and not weaving side to side. When you get to the last 1" or so, stop gluing. Carefully measure and cut off the unglued end of the tubing to proper length to mate up with the first end. Prepare a small "splice" to go inside the two ends of the tubing. A balsa stick approximately 1/16" square x1/4" long should be about right. Cut it from a piece of scrap 1/16" laser-cut balsa sheet. Glue it halfway inside one end to the tubing, and then join the other end up to it. Holding everything in position, finish gluing the end of the tire to the wooden wheel.

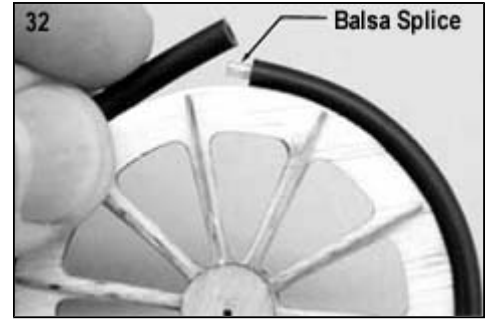

33. Locate the 1/4" dia. x6-3/4" balsa dowel main gear Spreader and the 1/4" dia. x6-1/8" birch dowel Main Gear Post. Make a half-round notch in one end of the Main Gear Post so it mates up nicely with the Spreader. Glue the Main Gear Post in the middle of the Spreader.

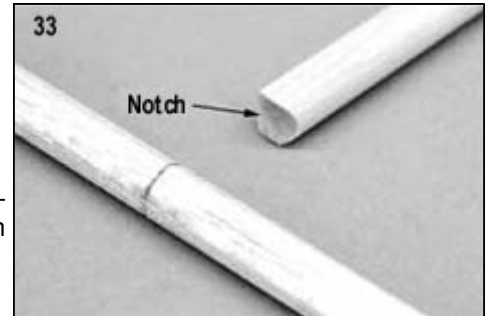

34. Locate the two .046" dia. formed Landing Gear Brace Wires. Study the LANDING GEAR FRONT VIEW on the plan so you will understand where these brace wires go. Tack glue both brace wires to the landing gear assembly with Thin CA. Then, tightly wrap the attachment of the braces wires to the gear with the Dacron Thread provided. After you complete all three bindings, soak the thread wrapped areas generously with thin CA glue and then, wipe dry with a rag.
35. Drill a .046" dia. hole in the center of each end of the balsa Spreader. Make the holes about 15/16" deep. Press a .046" dia. x1-1/2" straight music wire Axle into each hole. Leave about 9/16" of the Axle wire sticking out of the end of the Spreader. Make sure the Axle comes out straight and parallel to the Spreader. Then, flow Thin CA glue around the wire. It will soak into the balsa Spreader, gluing the wire permanently in place. Let dry.

36. Place the wheels on the axles and double check that they rotate freely. Then, press the 1/32" laser-cut plywood WRT wheel retainers onto the axles. Slide WRT up tight against the wheel, and then back it off about 1/32" so the wheel can turn freely. Put a drop of Medium or Thick CA glue, or epoxy glue, on the outside of WRT to hold it on the axle.



- 37a. Use a #11 hobby knife to make a 1/4" dia. hole in the bottom of the fuselage to accept the Main Gear Post. Make the hole right at the back edge of the Keel that is inside the fuselage (see side view plan).

Tip: Before starting the hole, locate the back edge of the keel precisely along the bottom longeron of the fuselage by pushing a pin up thru the longeron. If you miss the first time, keep trying until you have the back edge of the keel exactly located. Then mark and cut the 1/4" dia. hole from that point.



- b. When you have the hole finished, insert the Main Gear Post thru the hole, up along the back edge of the Keel, and then into the space between former F4 and the 1/8" sq. balsa crosspiece that is right in front of F4. Check the alignment of the gear assembly to the fuselage and adjust as necessary. When you get the alignment just right, glue the gear assembly securely in place; gluing the gear post to the bottom of the fuselage, the back of the keel, and to the front of F4.

- 38a. The Antoinette's front landing gear skid is made of a plywood and balsa lamination. Locate the plywood core LG1 and balsa parts LG2, LG3, and LG4. Start by gluing a balsa LG2 on each side of LG1, being careful to line up all the edges carefully. Make sure you keep the assembly flat. Don't create a bow or twist in the assembly by gluing the parts together in mid air. Work on a flat surface while gluing.

- b. Glue balsa parts LG3 and LG4 in place on each side of LG1.
- c. When dry, block sand all the edges of the skid assembly to clean up any rough spots.

Note: Old photos show that the landing gear skids on the original Antoinettes were square cornered, not rounded or airfoil shaped as you might think they would be. Remember, this was just 6 years after the Wright brothers first flew! Streamlining was not a big consideration at the slow speeds these airplanes flew.

- 39. Glue the skid assembly in place on the fuselage.
Note: You may have to adjust one or more of the skid's struts slightly to mate up perfectly with the rest of the airplane. With three contact points, and a potential for small variations in the length of the main gear post, the skid may not mate up perfectly the first time. Adjust as needed.
- 40. Glue plywood part LG5 in place on the bottom of the landing gear assembly.

- 41. Glue plywood part LG6 in place on the back of the main gear post.
Tip: Working with these small parts can be tedious! Try this. Mark the location for LG6 on the back of the gear post. Holding LG6 with a needle nose pliers, put a small bead of Medium CA glue on the mating edge. Quickly spray the back of the gear post with CA Accelerator.

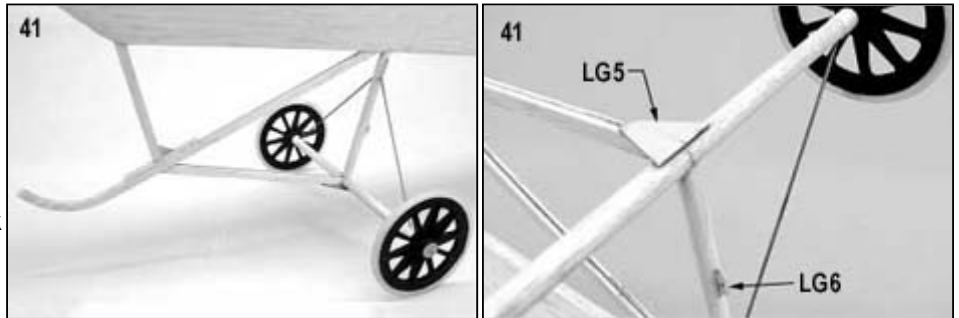

Touch LG6 to the back of the gear post, lining it up with your marks. The part will be glued in place just as soon as it contacts the accelerator soaked gear post. Let go.

- 42. Glue the other LG6 plywood part in place on the bottom of the fuselage, beneath former F5.

WINGS

- 44. Four 1/4" dia. balsa dowels are provided for making the leading and trailing edges of the wings. Notice that each dowel has a 6-1/8" long slot in one end. Glue a 1/32" plywood WSF wing stiffener in each slot with thin CA. Make sure the edges of the WSF plywood do not protrude outside the diameter of the dowel.

When dry, sand very lightly to smooth out any rough spots. Then, trial fit the stiffened end of the dowel inside one of the 1/4" id aluminum wing mount tubes. If the dowel is too big, gradually sand it down until it fits properly. You want the wing dowel to fit inside the aluminum tube with a little bit of friction, but not too much.

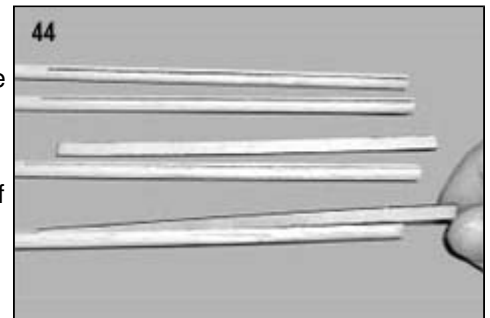

The idea is to achieve a snug fit that will hold the dowel in place, yet allow the dowel to be easily removed when you want to take the wings off your airplane. Obviously, you don't want it so loose that the dowel falls out.

- 45a. Lay two of the balsa dowels on the wing plan for Leading Edges. Make sure the plywood-reinforced end of the dowels is at the root end of the wing panels. Then, mark and cut the dowels to proper length.
- b. Lay two of the balsa dowels on the wing plan for Trailing Edges. Make sure the plywood-reinforced end of the dowels is at the root end of the wing panels. Then, mark and cut the dowels to proper length.
- 46. Cover your wing plan with wax paper or plastic wrap for protection. Working on one wing panel at a time, pin the trailing edge, leading edge, and all the wing ribs W1 thru W8 in exact position on the plan. Double check to see that you have the plywood reinforcements in the root ends of the dowels situated vertically for maximum strength. After these parts are securely pinned in place, glue all the joints with thin CA.
NOTE: It's best not to push pins through the leading and trailing edges. Instead, straddle these narrow parts with crossed pins pushed into the building board. Look closely at the photos and you'll see what we mean.

47. Glue in the balsa wing gussets WG1, WG2, WG3, and WG4 in the four corners of the wing panel.

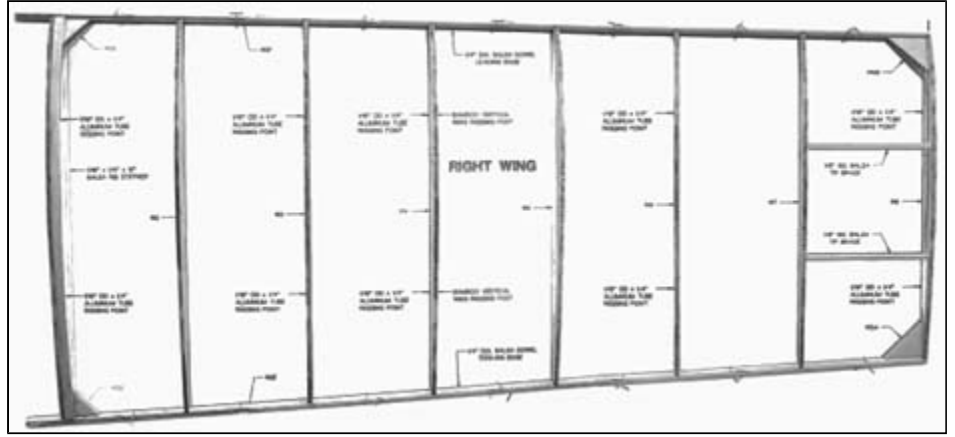

48. Glue a 1/16"x1/4" balsa cap strip along the inside of the W1 wing rib. It should be flush with the top edge of the rib.

49. Cut to length and glue in position the 1/8" sq. balsa Tip Braces. (see the photo)

49. Use a 90 deg. triangle to mark the locations of the 1/16" od x1/4" Aluminum Tube Rigging Points (10 per wing panel) onto the faces of the appropriate wing ribs. Glue the rigging points to the ribs at those locations. Be careful not to get any glue inside the tubes.

Note: The two Rigging Points on rib W1 must be installed thru the 1/16"x1/4" balsa cap strip.

50. When dry, the entire wing can be removed from the building board. Double check all the joints for adequate glue and apply a little more if necessary. Clean up any rough edges with a fine grit sanding block.

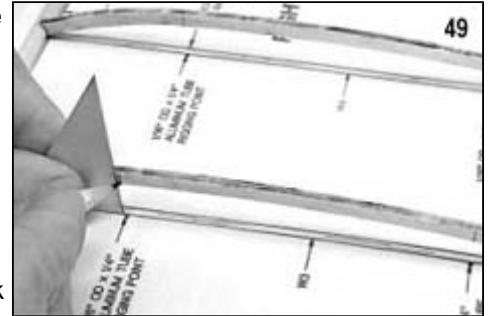

Repeat Steps 46 through 50 to construct the opposite wing panel.

51. Use a sharp #11 hobby knife to make 3/8" dia. holes in the fuselage side sheeting where the trailing edges of the wings will be mounted. Make sure the bottom of the hole is flush with the top of the rear dihedral brace RDB.



Tip: Before starting the hole, locate the top edge of RDB precisely on the outside of the fuselage by pushing a pin thru side sheeting from the inside. Then, mark and cut the 3/8" dia. hole from that point. Also, due to the fragile nature of the side sheeting, it's best to make the hole undersize first, and then, gradually open it up closer to finished size. Finish shaping and sizing the hole with sandpaper wrapped around a scap of 1/4" dowel.

52. Sand the outside of the four 1/4" id x1" Aluminum Wing Mount Tubes with 220 grit sandpaper to improve glue adhesion. Then, slip the wing mount tubes onto the root ends of the leading and trailing edges of both wing panels.

Now, trial fit one of the wing panels to the fuselage, resting the wing mount tubes in position against the FDB and RDB dihedral braces in the fuselage. When you have the wing panel lined up properly, have a helper put a single drop of thin CA glue between the aluminum tube and dihedral brace. Don't over glue at this point or the excess glue might seep inside the tube, permanently gluing your wing panel into the tubes.

After tack gluing both the front and rear tubes to the dihedral braces, have your helper slowly pull the wing out of the tubes, while you continue to hold pressure against the tubes, keeping them from breaking loose. After the wing is removed, re-glue the wing mount tubes securely to the surrounding fuselage structure with medium or slow CA. Avoid getting any glue inside the aluminum tubes.



53. After one set of wing mount tubes has been installed, repeat the same procedure to install the wing mount tubes for the opposite wing panel.
54. Glue the laser-cut plywood WM wing mounts in place over the front wing mount tubes. You will have to use your hobby knife to angle the edges of the holes slightly to allow the aluminum tubes to fit.



Set the wings aside until needed later.

TAIL SURFACES

55. Cover the Stabilizer/Elevator plan with wax paper or plastic wrap for protection. Use 1/8" square balsa sticks and laser-cut parts S1 and S2 to construct the Stabilizer directly over the drawing. When dry, unpin the Stabilizer from the plan and lightly sand all the glue joints smooth.

Note: Remember to cut the longest pieces of 1/8" sq. balsa first, then the shorter pieces, in order to make the most efficient use of the stock 36" long sticks.

56. Use 1/8" square balsa sticks and laser-cut part CHG to construct the Elevator directly over the drawing. When dry, unpin the Elevator from the plan and lightly sand all the glue joints smooth.
57. Cover the Fin/Rudder plan with wax paper or plastic wrap for protection. Use 1/8" square balsa sticks to construct the Fin directly over the drawing. When dry, unpin the Fin from the plan and lightly sand all the glue joints smooth.
58. Use 1/8" square balsa sticks and laser-cut part CHG to construct the Rudder directly over the drawing. When dry, unpin the Rudder from the plan and lightly sand all the glue joints smooth.

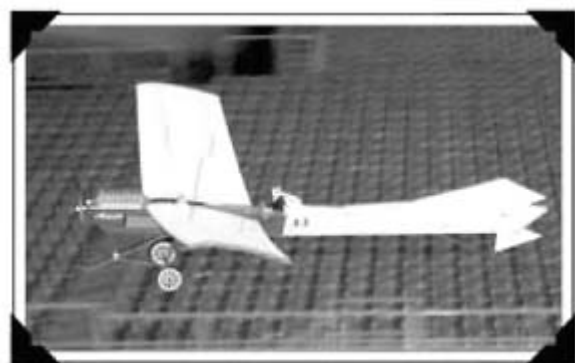
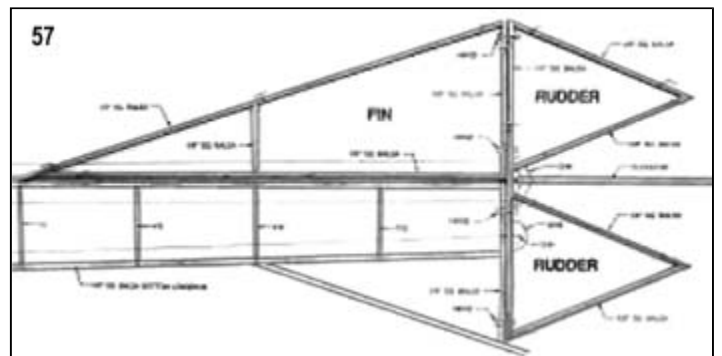

COVERING

The covering material included in this kit is Litespan, by Solarfilm. It is a strong, tough, heat-shrinkable synthetic covering material. Litespan is very light weight, approximately 32 grams per sq. yard. Litespan is heat shrinkable, however it does not have glue already on it. You must first apply adhesive to the model structure where you want the covering to stick, using a heat-activated liquid adhesive such as SIG Stix-It or Solarfilm Balsaloc (not supplied). The following parts of the Antoinette need to be covered:

- Wings - cover top only
- Fuselage Sides - cover from former F7 to the tail post
- Fuselage Top - cover from former F7 to former F9
- Fin and Rudder - cover both sides
- Stabilizer and Elevator - cover top only

Note: When covering the stabilizer, study the plan carefully to determine which side is the top. The determining factor is the location of the control horn. It must end up on the left side of the airplane.

Refer to the "COVERING DIAGRAM" to see how to make best use of the covering material provided.

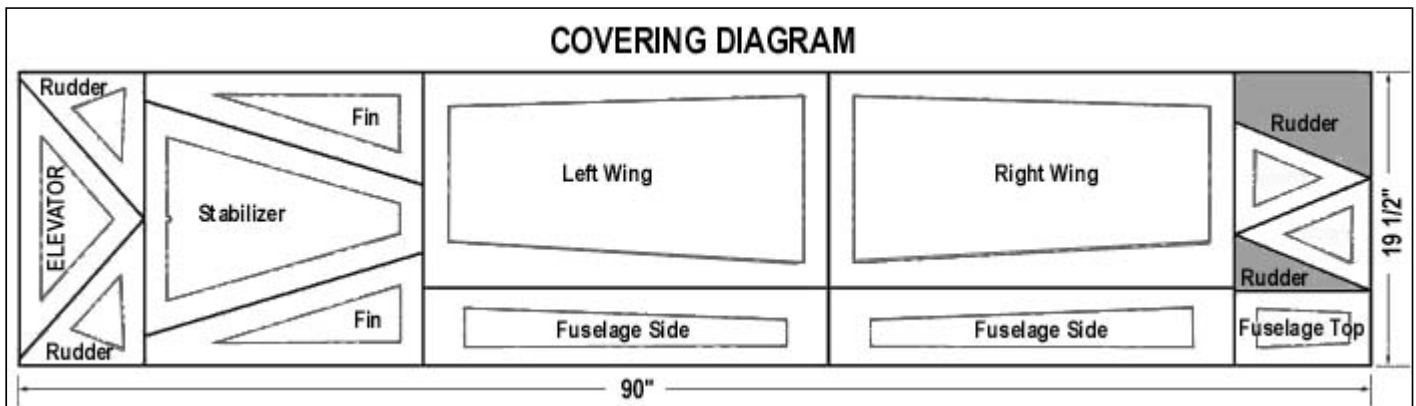

Surface Preparation

Lightly sand the parts to be covered, removing any bumps and unevenness that would show through the covering. Start with 80 or 100 grit sandpaper on a sanding block, and finish with 220 grit or finer sandpaper. Fill all cracks and hollows with light weight model filler and sand smooth. Coat the areas where you want the covering to stick with the heat-activated adhesive, following the manufacturer's instructions. On both wing panels, apply adhesive to the leading and trailing edges, the tip and root ribs and to the top surface of each wing rib. Allow the adhesive to dry to the touch.

Pre-Shrinking

Litespan is capable of shrinking a great deal. We have tried several methods to control this tendency, including pre-shrinking the material. Doing this tends to take some (not all) of the "shrink" out of the material. This can be desirable when trying to minimize any tendency to warp the part being covered. To do this, first cut the piece to shape (such as one of the wing panels), leaving at least an inch or so of material around all edges. Place the material on a clean, flat heat-resistant surface (dull side up). With your iron set to about 200 deg. F, iron the material smooth, shrinking it in the process. The piece is now ready to apply as described below.

Adhering

Set your covering iron temperature to between 195 deg. F and 210 deg. F. Lay the Litespan on the framework and smooth out the wrinkles. Tack the Litespan in place at a few points around the edges, using the toe of the iron. While tacking, gently pull the Litespan to get a smooth fit without large wrinkles. Do not try to pull the Litespan drum tight, just smooth and wrinkle free. Reheating and peeling back while hot allows the Litespan to be repositioned. Then, seal the Litespan all around the edges of the wing with the iron. Trim surplus Litespan from around the edges with a sharp blade and reseal the edges if necessary.

Shrinking

Increase the iron temperature to between 250 deg. F and 285 deg. F. Shrink the Litespan by slowly sliding the iron across the surface of the Litespan - just lightly touching the surface. Be very careful not to over-shrink the Litespan because it will warp the light weight structure of the Antoinette. Do not try to shrink out every last little wrinkle. Just get rid of the largest ones. Remember, the full-scale Antoinette also had wrinkles in the covering.

NOTES ON COVERING IRONS:

We've found that a small "trim iron" (such as the Top Flite Trim Seal Tool) works better than a full-size covering iron when working with the Litespan on light weight model structures like the Antoinette. In fact, we use a trim iron for the entire covering process, both adhering the Litespan and then shrinking it. The small size of the trim irons' shoe places heat in a small area, allowing a lot of control. We can also tell you from experience that using a heat gun on Litespan is not a good idea. The heat from a heat gun is difficult to control and can cause uneven shrinking, which in turn causes warps.

FINAL ASSEMBLY

59. Find the bamboo Tail Skid that you made earlier during the fuselage construction, and glue it in place.

60. If you plan on painting the front of the fuselage and the tail skid, do it now. Let dry before proceeding.

61. Glue the Stabilizer in place on the fuselage. Notice the small circular shaped cutout in the trailing edge of the stabilizer. This is to accommodate the leading edge of the rudder. Make sure when gluing the stabilizer to the fuselage that you line the front of that cutout with the rear edge of the fuselage tail post. Now, glue the Fin in place on the stabilizer. Sight straight down the trailing edge of the Fin to make sure that it lines up with the fuselage tail post underneath the stabilizer.



62. Built into the front of both the rudder and elevator is a balsa control horn gusset CHG. Cut away the covering material over the small slit in CHG. Insert a laser-cut plywood control horn CHN into the slit, center the horn, and then, glue with Thin CA.

63. A single SIG Easy Hinge, measuring 3/4"x1", is provided for hinging the rudder and elevator. Cut the Easy Hinge into 8 pieces that measure 1/8"x1/2".

64a. Refer to the plans and mark the locations for (4) Easy Hinges on the leading edge of the rudder and on the trailing edge of the fin and tail post.

64b. Using a sharp #11 hobby knife, carefully cut small slits in the parts to accept the Easy Hinges.

64c. Insert an Easy Hinge halfway into each slit in the fin and tail post.
DO NOT GLUE THE HINGES IN AT THIS TIME.
Now carefully slide the rudder onto the exposed half of the hinges. You will find it easiest to slide the part onto the hinges at an angle, one hinge at a time. To set the proper amount of gap between the parts simply deflect the control surface to the maximum amount of travel desired in each direction. This will automatically set the proper hinge gap.



64d. Place a single small drop of Thin CA glue directly onto the hinges in the gap. You will notice that the glue is quickly wicked into the slit as it penetrates both the wood and the hinge. Because the hinges are so small, there is not need to put glue on both sides. The glue you put on the first side will flow around to the other side. Let the hinged parts dry before flexing.

CAUTION: SIG Easy Hinges are designed to be used with any THIN CA adhesive. Make sure you are using the thinnest variety. Do not use medium or thick CA, or any other type of glue, on Easy Hinges. Also, never use CA accelerator on Easy Hinges.

65. Repeat step 64 to hinge the elevator to the back of the stabilizer.
66. The 1/32" laser-cut plywood WTS wing tip skids provided in the kit are a decorative scale part. They are not structural or meant to be functional. You can leave them off if you want to without affecting the airplane in any way other than visually. We like them and feel that they add to the "Victorian Age" flavor of the Antoinette. If you agree, glue them in place on the tip end of each wing panel and paint them the same color as the front of the fuselage.

Decals

The decals provided in the kit are self-stick mylar stickers. They should not be dipped in water! Simply cut out the decal design with a sharp hobby knife or scissors, cutting as close to the image as possible. Remove the design off the backing paper with tweezers and carefully place it in position on the model. Gently rub the decal onto the part with your finger tip.

RADIO INSTALLATION

Rudder

- 67a. Study the plans and cross-section F7 to understand how the rudder servo is mounted in the fuselage.
 - b. A piece of 1/8"x1/4"x3" long basswood is provided for making servo mounts. Cut two 11/16" long pieces of basswood for the rudder servo mounts. Bevel the ends of the pieces to fit against the fuselage side sheeting, as shown in the cross-section drawing.
 - c. Mount your rudder servo to the basswood servo mounts with the screws that came with the servo. Be sure to drill pilot holes in the mounts so the screws won't split the wood.
68. Set the rudder servo (minus the control arm) in place in the fuselage. Check the fore and aft positioning of the servo in comparison to the side view plan. The output shaft of the servo should be 2-1/8" ahead of former F7. Also, check to see that the servo sits far enough down in the fuselage. If you made your basswood servo mounts the correct length, it should automatically fit at the right height. When you have the servo properly located, glue the ends of the basswood servo mounts to the insides of the fuselage side sheeting.
69. Use a sharp #11 hobby knife to make a cutout in each side of the fuselage for the rudder servo arm. The dimensions for the cutouts are shown. If you've located your rudder servo in the right place, it's output shaft should be centered in the middle of the cutouts you just made. If not, you'll have to adjust the cutout.

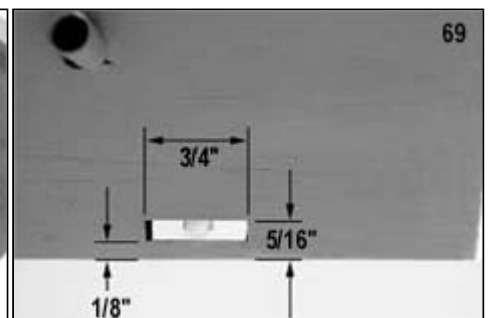

- 70a. Installing the servo control arm onto the servo is a little tedious, but not difficult if you work carefully. First, on the inside of the fuselage, loosen the servo mounting screws enough to allow you to lift the servo up until its output shaft is clear of the cutouts in the fuselage sides.
 - b. Now, insert the servo control arm through the cutouts and press it onto the servo output shaft.
 - c. To put the control arm retaining screw in place, drill a small hole in the bottom of the fuselage just large enough to get your smallest screwdriver through to put the screw in.
 - d. Re-tighten the servo mounting screws inside the fuselage.

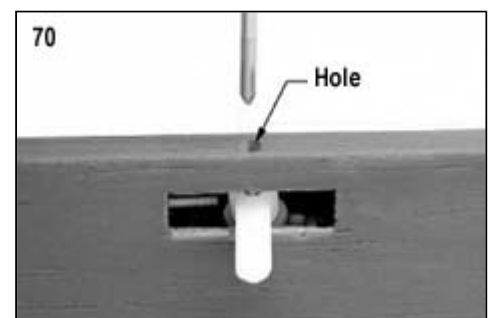

71. Pull-pull control lines are used to connect the rudder servo to the rudder control horn. A 10 foot long piece of monofilament fishing line is provided for this. Cut it in half into two 5 foot long pieces, one for the rudder and one to use later for the elevator.
- 72a. Begin by slipping one of the 1/16" od aluminum swage tubes over one end of the monofilament line. Slide the tube up the line a little ways, leaving you about 4-5 inches of line to work with. Now, stick that short end of the line through the hole in left side of the rudder control horn. Then, loop the end of the line back through the aluminum swage tube. Slide the tube up close to, but not touching, the control horn. Use needle nose pliers to crimp the swage tube flat, tight against the lines. Trim off the short end of the line close to the swage tube.
- b. Next, poke the other end of the monofilament line through the outermost hole on the left side of the rudder servo control arm. Take the line all the way across the top of the control arm and down through the outermost hole on the right side of the arm. Then, run the line back to the right side of the rudder control horn. Swage the line to the right side of the control horn in the same manner you did the left side. Make sure you pull all the slack out of the monofilament line on both sides of the rudder servo before you crimp the swage tube flat. Just snug it up, but not so tight that you distort the airplane's light structure. And don't worry about getting the rudder exactly centered at this time. That's in the next step.
- c. After you have your radio system hooked up and functional, you can adjust the pull-pull lines to center your rudder in neutral position. First, center your rudder servo arm in neutral position. Then, adjust the rudder to neutral position by sliding the monofilament line through the servo arm, lengthening one side while you shorten the other side at the same time. When you have the rudder properly neutralized, secure the pull-pull line by placing a single small drop of glue on the line where it passes through one of the holes in the servo output arm.

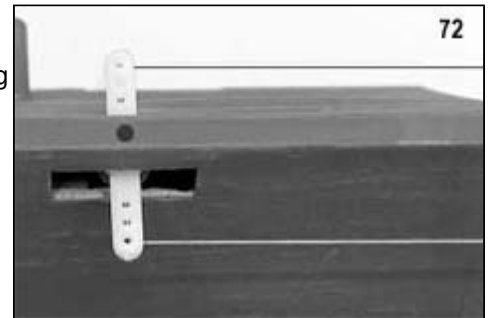

NOTE: In all the hours of indoor flying we've done with the Antoinette and other models, we've never found it necessary to readjust the neutral position of the rudder or elevator once they were secured in position.

If your rudder servo is perfectly neutral (including the trim lever on your transmitter) and your rudder is perfectly centered when you glue the line to the servo arm, the trim lever on your transmitter will easily cover any flight trimming adjustments that may be needed. If you ever need to replace the pull-pull lines, it's a simple matter to chip the glue off the nylon servo arm, redrill the hole if needed, and put in new lines. Or simply replace the output arm with a new one.

Elevator

- 73a. Study the plans to understand how the elevator servo is mounted in the fuselage.
- b. Cut two 3/8" long pieces of the 1/8"x1/4" basswood servo mount material. Glue them inside the fuselage, at the front and rear edges of the elevator servo cutout in the fuselage side.
- c. Mark and drill pilots hole for the servo mounting screws. Then, screw the elevator servo in place.
74. Install monofilament pull-pull control lines to connect the elevator servo to the elevator control horn. Use the same procedures you used for the rudder hookup.

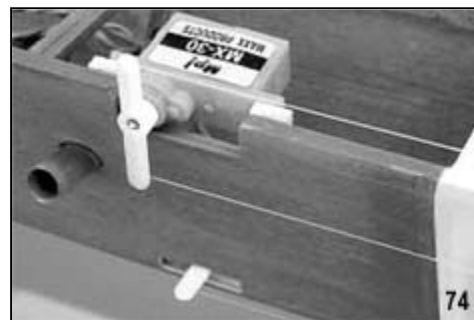

Receiver

Velcro® is supplied to mount your radio receiver to the balsa RXM receiver mount located right in front of former F6. For the receiver antenna, we drill a small hole in the bottom of the fuselage right in front of F6. Run the antenna through the hole and use a couple small pieces of clear tape to secure it to the bottom of the fuselage.

Battery

Velcro® is supplied to mount your battery pack to the balsa BTM battery mount located in front of former F3. The second BTM in back of F3 is for other possible battery configurations. We've never had to use it yet, but recommend that you leave it in the airplane for structural strength. It weighs next to nothing.

Control Movements

The following control surface movements are based on our many hours of flying time with our Antoinette models. Note: These measurements were taken at the rearmost tip of the rudder and elevator.

RUDDER 2" Right, 2" Left
ELEVATOR 1-3/16" Up, 1-3/16" Down

ELECTRIC MOTOR INSTALLATION

75. A laser-cut 1/16" plywood Motor Mount is used to adapt the GWS electric motor for "firewall" mounting in the Antoinette. To install the Motor Mount, we need to partly disassemble the GWS motor. Use a small screwdriver to remove the gear shaft split ring and washer from the back of the motor assembly. Pull the gear shaft and gear out of the plastic housing. Set aside these parts for re-assembly later.
76. With a small Phillips screwdriver, remove the four screws from the front of the motor's plastic gearbox. Also, remove the two smaller screws that hold the motor to the front of the plastic gearbox. Then, separate the front of the plastic gearbox from the rest of the motor unit.
77. Set the front of the plastic gearbox in the cutout in the plywood Motor Mount - it will slip in place and bottom out against the face of the Motor Mount. While holding the plastic part tight against the plywood, place a single drop of Thin CA glue at the three points shown in the photo. This tack glues the plastic part to the plywood.



78. Turn the assembly over and place a small drop of Med CA at the points shown and set the glue with CA Accelerator. The plywood Motor Mount is now adequately attached to the electric motor for normal flight, and yet it can be easily broken loose and removed later, if the need should arise.
79. Re-assemble the electric motor and plastic gearbox assembly.
80. Mount the electric motor assembly to former F1 using three #2 x1/4" Sheet Metal Screws. Notice that small pilot holes for the screws are already laser-cut in former F1.

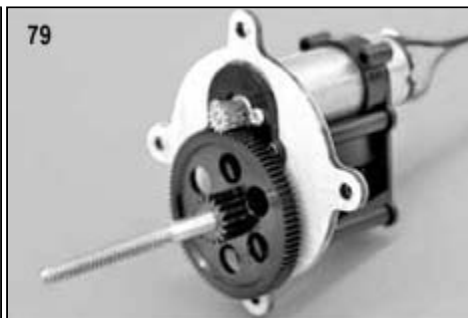

Tip: Put the bottom mounting screw in first! The big gear on the front of the motor partly blocks access to the bottom mounting screw. So while you still have the motor assembly in your hands, put a screw through the bottom hole of the plywood motor mount, angling it past the gear. You can flex the plywood mount just enough to get the screw all the way in the hole, with the head tucked up underneath the gear. Then, hold the motor assembly up to the front of the fuselage while you thread the bottom screw into F1. Once you have it in, you can put in the other two mounting screws.

Scale Dummy Engine

81. The scale-like dummy V-8 engine provided with your kit adds a nice look to the finished airplane. The engine is molded from .010 thick plastic in 3 separate pieces - 1 Crankcase, 1 set of 4 Cylinders for the right bank, and 1 set of 4 Cylinders for the right bank. Making the engine is not difficult, provided attention is paid to these instructions. Our finished, fully detailed and painted dummy engine typically weighs just 3 grams!

82a. Trim out the molded plastic Crankcase, leaving a 1/16" flange on all four sides.

Note: A sharp pair of miniature scissors works great for cutting these light weight plastic dummy engine parts.

b. Glue the Crankcase in place on the laser-cut 1/32" balsa Dummy Engine Base. The back end of the crankcase (the end with the sharper corners) goes right along the back edge of the Dummy Engine Base.

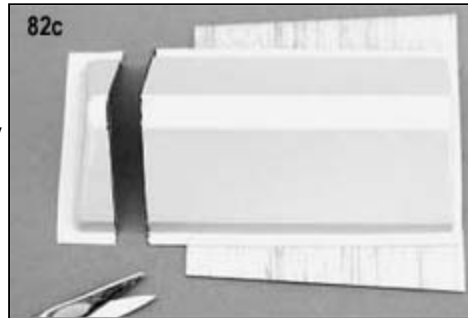

c. Mark and then, cut off the front end of the Crankcase vertically, 2-9/16" from the back end.

d. Trim out the bottom 1/4" of the back end of the crankcase so that it will clear the battery pack.

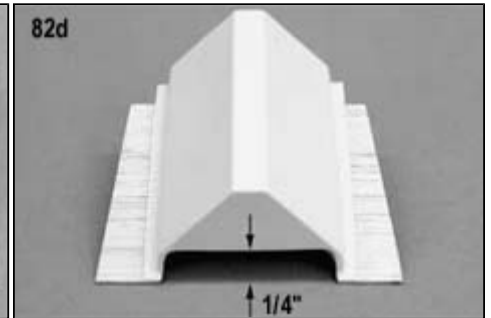

83a. Bend ENGINE HOOK #1 and ENGINE HOOK #2 out of .020" dia. music wire, according to the full-size patterns on the plan. Note: Since neither of these hooks will be seen, they don't need to be pretty, just functional. If yours don't match the plan exactly, don't worry about it, as long as they do the job.

b. Glue ENGINE HOOK #1 in place in the Dummy Engine Base. Two small holes are already laser-cut into the base for the wire hook. Make sure you have the hook facing the right direction.

c. Glue ENGINE HOOK #2 in place near the bottom of former F2. Two small holes are already laser-cut into the former for the wire hook. Make sure you have the hook facing the right direction.

d. A small rubber band (not provided) looped between the two engine hooks holds the dummy engine assembly in place during flight.



84a. Trim out the molded plastic Cylinders, leaving a small flange all the way around the perimeter.

b. Draw a line exactly thru the middle of the each cylinder bank, and then, cut them in two.

c. Hold the cylinder sections in alignment and tack glue them together with a tiny drop of Thin CA, placed right on top of each cylinder. The Thin CA will flow along the flanges, instantly gluing the parts together.

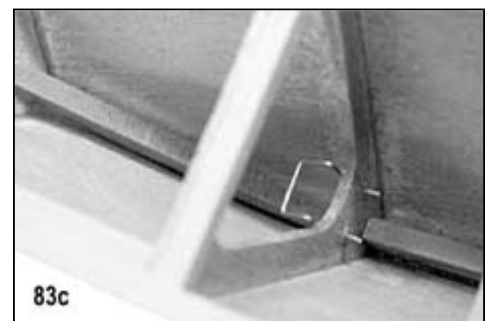

When dry, reinforce the seams by applying a little Thick CA glue on the inside of the cylinders. Let dry.

84d. Carefully drag the bottom of the cylinder bank against a fine sanding block (150 grit or finer) to even out the edges. Don't try to sand too fast or too hard. You'll crush the thin plastic. Just drag the part lightly back and forth across the block and let the sandpaper do the work.



e. The excess flange around the outside of each cylinder bank can now be carefully trimmed and sanded to final shape. Use 220 grit sandpaper and/or small jeweler's files. Do not attempt to eliminate the seam completely, but rather work to make it as uniform as possible for a good appearance. When the engine is painted, the seam lines become very muted and won't detract from the scale appearance.

85. If you intend to paint your cylinders a different color than the crankcase, like we did ("steel" for the crankcase, "copper" for the cylinders), then you should paint them now. Allow the paint to dry before continuing.



86a. Cut four 1/2" long pieces of 1/8" sq. scrap balsa stick. Adjust the length of the sticks as needed to fit inside the bottom of both end cylinders of each cylinder bank. Glue the sticks in flush with the bottom edge of the plastic cylinder. These sticks provide more gluing surface for attaching the cylinder banks to the crankcase in the next step.



b. Put a drop of Medium CA on the balsa gluing sticks and then, carefully set the cylinder bank in place on the side of the crankcase. Prop the assembly up so the cylinder bank won't fall off and leave it alone to dry.

Note: We don't use CA Accelerator during this installation because it can mar the metallic paints we used on the cylinders and crankcase. Most brands of Medium CA will dry on its own, without accelerator, in 15-20 minutes.

c. When dry, glue the second cylinder bank in place on the other side of the crankcase. Let dry.

87. The dummy engine assembly, as provided in the kit, is now basically complete. For some modelers, this may be enough and they will want to move on. However, there are always those who want a little more "eye candy" and will want to fully detail the engines. For these folks, we'll share some additional detailing tips that we used on our dummy engines (materials for these additional details is not provided).

As mentioned earlier in the PAINT section of this manual, we used a selection of flat Testor's Model Master™ plastic model paints - both spray can and brushable types - for painting and detailing the dummy engine. The plastic crankcase was sprayed with Steel. The cylinders were sprayed with Copper. We made the exhaust pipes out of 1/8" od K&S™ Aluminum Tubing, carefully bent to shape, and then, painted with Burnt Metal Buffing Metalizer™. Thin or medium CA glue was used to attach the finished exhaust pipes to the cylinders.

The "sparkplugs" were made from 1/32" K&S™ Aluminum Tubing. Spray or brush the tubing with Flat White or Flat White Primer and allow to dry. Cut 1/4" lengths of the painted tubing for the sparkplug bodies. Cut 3/8" lengths of .031 music wire for the sparkplug tips. Glue one of the music wire pieces into each sparkplug body, leaving 1/8" of wire exposed. Use medium CA glue to install the spark plugs into pre-drilled holes in the top of each cylinder head. Use a 1/2" long piece of leftover 1/4" balsa dowel to simulate a distributor on the back end of the crankcase.



The sparkplug wires are made from thin black or gray R/C hook-up or antenna wire. Cut the 8 sparkplug wires to length, plus an extra inch on each one to work with.

Use a pliers to pull the metal wire out of the plastic insulation. One end of the plug wire is placed over the wire tip of each sparkplug (warming the tubing with a little heat relaxes it enough to do this). The other end of the tube is inserted into a distributor. Done neatly, the overall effect can be very convincing!

GWS propellers are excellent products but they are molded in bright orange plastic! To make ours more realistic, we painted them. First, balance the prop with a prop balancer. If needed, sand the backside of the heavier blade to bring the prop into balance. Lightly sand the entire prop with worn out 220 grit sandpaper and wipe it down with alcohol to clean the surface.

For our props, we used Model Master spray paints - either Light Earth or Sand Beige will create a nice wood look.

Optional Dummy Gas Tank

The gas tank on a full-scale Antoinette is a prominent detail, in full view on top of the fuselage. In fact, some of the old photos of Antoinettes show multiple gas tanks lined up on top of the fuselage, undoubtedly for long range or endurance record setting attempts. The single gas tank shown on the plan is easy to make, quite light, and when painted and mounted in place, adds a lot of interest to the look of the model.

Note: No materials are provided in the kit specifically for making a dummy gas tank. To make the one shown on the plans you will need some scrap 1/32", 1/16", and 1/8" sheet balsa.

- 88a. Start by finding a piece of hard metal or plastic tubing that is about 1" in diameter (we used a length of K&S brass tubing). The tubing will be used as a "form" to make the balsa tank cylinder.
- b. Use a piece of light 1/32" balsa sheet, cut to 1-1/2" long. Roll the balsa sheet tightly around the tube until you have the edges overlapped. Secure it tightly with a piece of tape. With a straightedge and sharp hobby knife, cut away the excess balsa to create a tight seam between the edges of the sheet.
- c. Slip a 3" or so length of waxed paper between the balsa sheet and the tube, beneath the seam. Hold the seam together and use Thin CA to glue the seam together.
- d. When dry, slip the balsa tube off of the form and remove the waxed paper from inside.

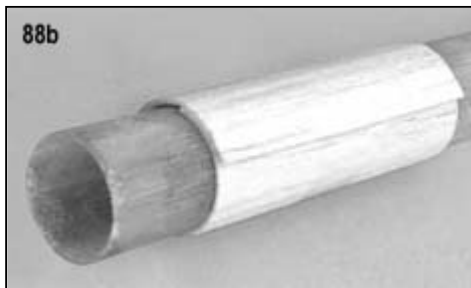

- 89a. Cut two 1/16" thick balsa End Caps and glue them in place inside the ends of the balsa Cylinder. Sand the edges of the balsa Cylinder flush with the End Caps.
- b. Add the 1/8" balsa Stands, the 1/8" balsa Neck and 1/16" balsa Cap to the gas tank.
- b. Paint the gas tank, let dry, and then, mount it on the fuselage. Use 1/8" wide plastic tape to simulate the Straps. Total weight of our finished, painted, and mounted tank was 1 gram.



Optional Dummy Radiators

Like the gas tank, the radiators on the full-scale Antoinette fuselage are a very prominent detail that can add a lot of interest to your model. A full-size drawing of the simplified scale-like radiators we built for our prototype models is shown on the plan. You will need to make two, one for each side of the fuselage.

Note: No materials are provided in the kit specifically for making dummy radiators. To make the one shown on the plans, you will need some scrap 1/16" sq., 3/32" sq., and 3/16" sq. balsa sticks.

90a. Start by cutting 1/16" sq. balsa sticks for the radiator Frame and Crosspieces. Glue them together over the plan.

b. Cut pieces of 3/16" sq. balsa stick for the Ends. Glue in place on both ends of the frame.

c. When everything is dry, carefully remove the frame assembly from the building board. Carve and sand the 3/16" sq. Ends to quarter-round shape.

d. Paint the frame assemblies and set aside to dry.

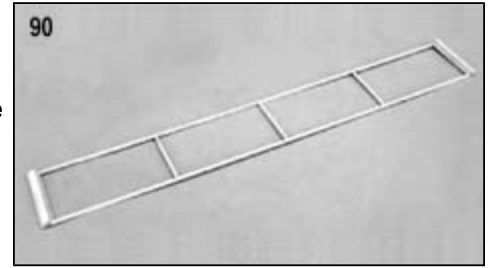

91a. The radiator tubes are made of 3/32" sq. balsa sticks, sanded round. Start by cutting 16 pieces (enough for both radiators) of 3/32" sq. balsa x12" long. This is just slightly longer than the finished size of the radiator tubes, but gives you something to hold onto during shaping and painting.

b. I know what you're thinking now ... "It's going to take me a week to sand all those sticks round!" Fear not! Here's a neat trick to make this job a lot easier and faster. Use a metal "Screw Checker" to shave off the corners of the balsa sticks before sanding.

Note: A Screw Checker is a flat metal plate with varying size threaded holes of all the common screw sizes. It's designed to make it easy for someone to determine the thread size of an unknown bolt by screwing it into the holes until you find one that fits. Screw Checkers are obtainable from Sears and other tool supply outlets.

c. Push the first 3/32" sq. balsa stick through the 6-32 hole of the Screw Checker. There will be a little resistance as the Screw Checker starts to shave off the corners of the balsa stick. Turn the stick around and push it through the hole again in the opposite direction. Continue passing the stick through the 6-32 hole until no resistance is felt.

d. Next, push the balsa stick through the 5-40 threaded hole in the Screw Checker. This will be pretty snug the first time through. Turn the stick around and run it through in the opposite direction. Keep pushing the stick through the 5-40 hole until little resistance is felt. It may take several passes.

e. Now, push the stick through the 4-40 threaded hole of the Screw Checker. Keep pushing the stick through the hole until little resistance is felt. It will take several passes.

f. Finally, push the stick through the 3-48 threaded hole. After several passes through this hole, the balsa stick should be round.

g. Finish sand the stick to final shape with a piece of fine sandpaper. Repeat the process to round the rest of the balsa sticks.

h. After you've got all the radiator tubes shaped, paint them and set aside to dry.

92. Glue the radiator tubes in place on the frame. It only takes a few small drops of Thin CA to secure them. Then, glue the entire radiator assembly in place on the fuselage side. See plan for exact location.



Rigging Wires

Installing scale-like "rigging wires" on your Antoinette is well worth the small effort and really makes the airplane come alive. This non-functional rigging serves only one purpose, and that is to add interest to the finished model. The process is easier than you may think.



For reference, we've included a 3-view "Rigging Diagram" of the Antoinette at the end of these instructions. This drawing shows and identifies the rigging locations we put on our factory-built Antoinette models. The "rigging wires" are actually black elastic thread, and an 8 yard long piece is included in this kit to make all of the rigging you see in the diagram. You will also need the remaining 1/16"od x1/4" aluminum swage tubes, a good pair of small needle nose pliers, a sharp #11 blade, and some thin CA glue.

TENSIONING: A little information about the elastic thread and how to use it will be helpful. Because it's difficult to convey "how much" to stretch this thread during the rigging process, we'll tell you that we use a 2:1 ratio. This means that to get adequate tension on all rigging lines, stretch them to approximately twice their relaxed length. For example, a relaxed 12" length of thread is stretched to about 24", providing the right tension. With this in mind, the 8 yards of rigging thread included in the kit is really 16 yards in actual use - more than enough to complete the model.

- 93a. Cut a piece of bamboo 8" long for the Center Rigging Post. Sand one end of the post round. Drill a .025" - .031" dia. hole through the post, about 1/8" from the rounded end. Paint the Center Rigging Post to match the rest of the forward fuselage. Let dry.
- b. Glue the Center Rigging Post in place in the fuselage as shown on the plan. Be sure that the hole in the top of the Center Rigging Post is aligned span wise to the model, across the width of the fuselage.
- 94a. Cut four pieces of bamboo 4-5/8" long for the Wing Rigging Posts. Sand both ends of each post round. Drill a .046" dia. hole (3/64" or #56 bit) in both ends of each post, about 1/8" from the end. Make sure the holes are facing the same direction, parallel to each other. Paint the Wing Rigging Posts and let dry.

- b. Install two Wing Rigging Posts in each wing panel on the outside of rib W4, as shown on the plan. An "awl" works good for punching a small hole through the wing covering at each post location. Slide the posts through the holes until there is an equal amount of post above and below the wing rib. Align the posts by eyeball, sighting from the root end of the wing, making sure the posts are parallel to each other, and that they are perpendicular to the "chord line" of the airfoil. Also, make sure that the holes in the ends of the posts are running span wise to the wing. When satisfactory, glue the Wing Rigging Posts to the side of the W4 wing rib.

Chord Line = in this case, it's an imaginary straight line running from the center of the leading edge to the center of the trailing edge.

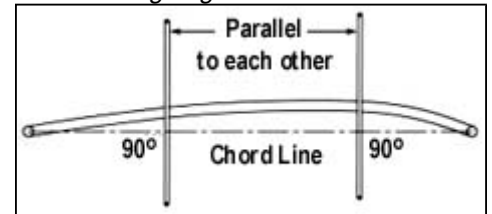

- 95a. Make three Rigging Hooks from .020" dia. wire. A fullsize pattern of the Rigging Hook is shown on the plan.

- b. Glue one Rigging Hook in the hole in the top of the Center Rigging Post in the fuselage. Use a small drop of Medium CA glue and set with accelerator.

- c. Glue the other two Rigging Hooks in place in the landing gear, where shown on the side view plan.

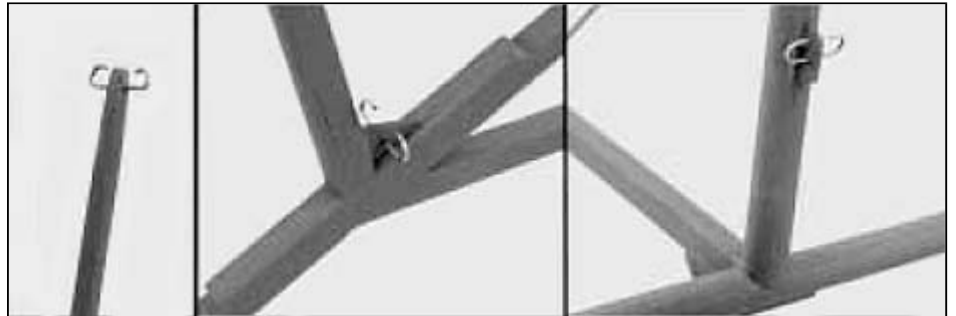

96. In preparation for installing the rigging wires on the wings, you must first pierce a hole in the covering material over each aluminum tube rigging point in the wing (A through J on the Rigging Diagram) to allow the rigging lines to pass through the tubes. The absolute easiest and neatest way to do this is with a sharpened metal point, such as an awl or a thin nail. Use a lighter or torch to heat the metal point and press it through the covering, into the aluminum tube. This makes a neat, perfectly round hole that is sealed around its edges. Open all ten tubing holes on both wing panels.

97. Referring to the Rigging Diagram, the first rigging wire we're going to install runs from rigging point B, through hole CT in the top of the rear Wing Rigging Post, then, through the tube at rigging point D, through hole CB in the bottom of the rear Wing Rigging Post, and then, finally back to point B.

- a. Cut a 13" length (unstretched) of elastic thread.

Tip: When cutting the elastic thread, avoid fraying by using a sharp new razor blade.

- b. At one end of the elastic thread, apply a single drop of Thin CA glue to the tip of the thread and harden it with CA Accelerator. Use a razor blade to cut the hardened tip at a sharp angle, leaving a "point". The pointed end of the thread will be used as a needle to route the rigging thread through the various rigging point locations.

- c. Glue the other end of the elastic thread to the side of wing rib W3 opposite the aluminum tube rigging point B. The easiest way is to first put a small drop of Thin CA on the rib, then place the end of the thread in the glue and set it with CA Accelerator.
- d. Now push the needle end of the elastic thread through the aluminum tube and out the top surface of the wing. Pull all of the elastic thread through the tube to the topside of the wing.
- e. Run the elastic thread through hole CT in the top of the rear Wing Rigging Post, then down through the aluminum tube at rigging point D, and through hole CB in the bottom of the rear Wing Rigging Post.
- f. Insert the needle end of the elastic thread in the aluminum tube at point B and secure it with a drop of Thin CA.

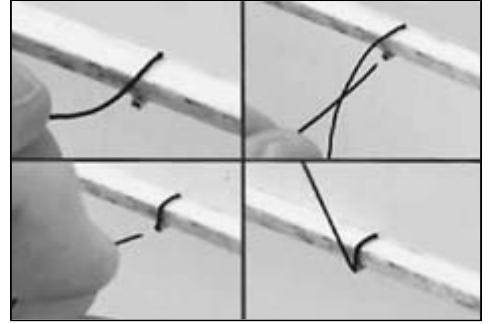

g. Adjust the elastic thread to equalize the tension in the four sections between the rigging points.

98. Repeat step 97 to install a 13" length (unstretched) of elastic thread from point G, through hole HT in the top of the front Wing Rigging Post, then, through the tube at rigging point I, through hole HB in the bottom of the front Wing Rigging Post, and then back to point G.

99. Repeat step 97 to install a 28" length (unstretched) of elastic thread from point A, through hole CT in the top of the rear Wing Rigging Post, then through the tube at rigging point E, through hole CB in the bottom of the rear Wing Rigging Post, and then back to point A.

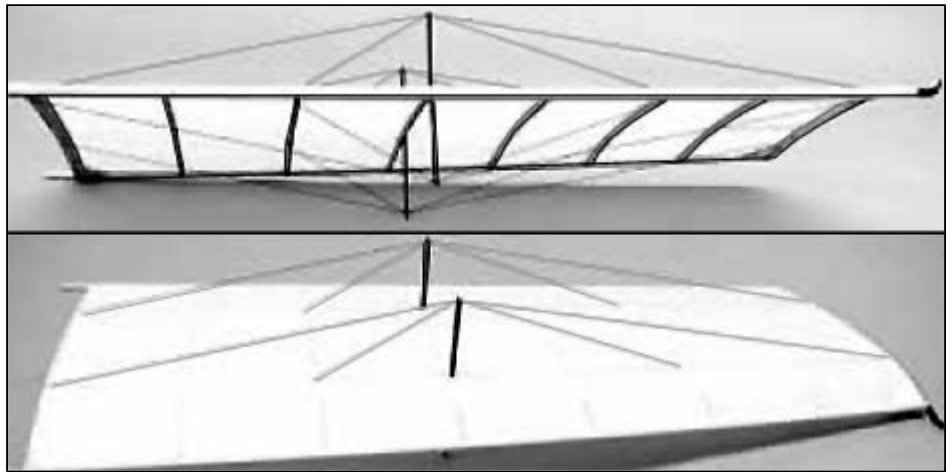

100. Repeat step 97 to install a 28" length (unstretched) of elastic thread from point F, through hole HT in the top of the front Wing Rigging Post, then, through the tube at rigging point J, through hole HB in the bottom of the front Wing Rigging Post, and then back to point F.

101. Repeat steps 97 through 100 to install the same rigging wires on the other wing panel. That will complete the installation of all the permanent non-detachable rigging wires on the wings. When done, install the wing panels on the fuselage.

102. The remaining rigging wires for the wings need to have swaged looped ends so that they can be detached from the fuselage whenever the wings are removed. The first detachable rigging wire we will install runs from point K, through the aluminum tube at point C, and then, down to point O on the landing gear.

a. Cut a 16" length (unstretched) of elastic thread.

b. Get a short (6" or so) length of scrap monofilament line. Hold the two ends of the monofilament line closely together and insert them both into one end of a 1/4" aluminum swage tube. Push the two ends through the tube, leaving a small loop of monofilament line sticking out of the tube.

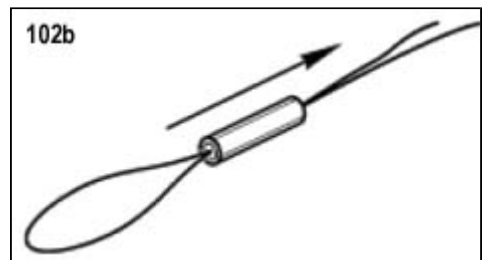

c. Insert about 1" of elastic thread through the monofilament loop and back against itself. Hold the elastic thread loop tightly and pull the monofilament loop through the aluminum swage tube, along with the elastic thread loop until about 1/4" (relaxed, not stretched) of looped thread is showing from the end of the tube.

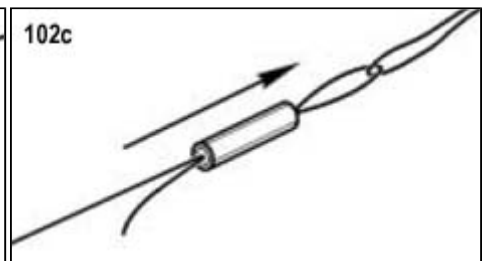
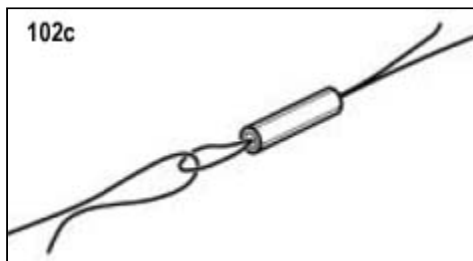

d. Remove the monofilament line and use small needle nose pliers to crush the middle of the swage tube, locking the thread loop in place. Trim off the short length of excess thread. This end of the rigging wire is done.

e. At the other end of the 16" thread, apply a single drop of Thin CA glue to the tip of the thread and harden it with CA Accelerator. Use a razor blade to cut the hardened tip at a sharp angle, leaving a "point". Push the pointed end of the thread through the aluminum tube at point C. Pull approximately half the thread out to the other side of the wing.

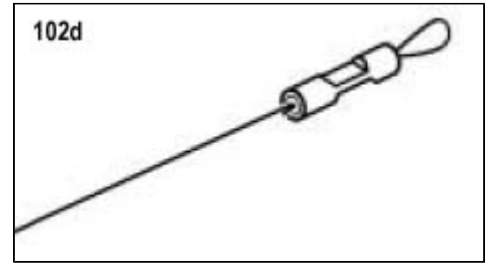

Now, repeat steps b, c, and d to make a swaged loop on this end of the thread. When done, hook the swaged loop ends of the rigging wire to the Rigging Hooks at points K and O.

103. Cut another 16" length (unstretched) of elastic thread and repeat Step 102 to install this rigging wire from point K, through point H, and down to point O.

104. Repeat Steps 102 and 103 to install the same rigging wires on the other wing panel.

105. The final rigging wire for the wing runs from point H down to the Rigging Hook at point N. Start with a 9" length of elastic thread. Simply glue one end of the thread to wing rib W4 at point H. Put a swaged loop on the other end of the thread - this end hooks over the Rigging Hook at point N. Make an identical rigging wire on the opposite side of the airplane.



This completes all the wing rigging wires. Unhook the wires and remove the wings from the fuselage to get ready for the next steps.

106. Cut three 7" long (unstretched) pieces of elastic thread for the rigging wires that go on the landing gear. None of these rigging wires needs to be removable. The ends are simply spot glued with a tiny drop of Thin CA onto the model structure as outlined in the following steps.

107a The first 7" long piece of elastic thread runs from point P on the axle, through the hole at point M, and ends at point Q on the axle.

Start by placing a tiny drop of Thin CA on one end of the elastic thread. Quickly place that end of the thread at point P, right in the corner between the landing gear brace wire and the wooden axle. The remainder of the piece of elastic thread should be facing the rear.

Set the glue with a squirt of CA Accelerator. It should bond the end of the thread to point P immediately and you can let go.

b. Poke the other end of the elastic thread through the hole in part LG6 at point M.

c. Spot glue the loose end of the elastic thread at point Q, in the same manner you did in the first end in step a.

108a Drill a .046" dia. hole (3/64" or #56 bit) through the landing gear at point N. The exact location doesn't need to be measured, simply place it somewhere near the middle of the junction of the 3 landing gear struts that meet at this point.

b. Use the procedures from Step 15 to install a 7" piece of elastic thread from point P on the axle, through the hole at point N, and then back to the axle at point Q.

109a Drill a .046" dia. hole (3/64" or #56 bit) through the landing gear at point L.

b. Use the procedures from Step 15 to install a 7" piece of elastic thread from the Rigging Hook at point O, through the hole at point L, and then, back to the Rigging Hook at point O.

When gluing the ends of the thread to the Rigging Hook at point O, we recommend simply wrapping the thread twice around the wire and then, gluing it permanently with a small drop of Thin CA.

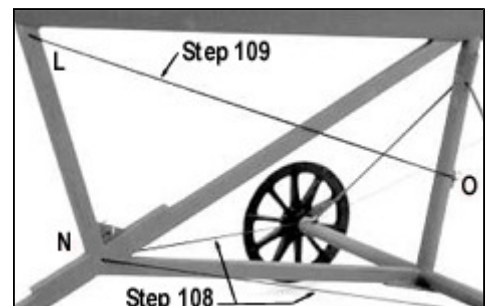

110a Drill .046" dia. holes (3/64" or #56 bit) through the top of the Fin at points R and T. Center the holes in the 1/8" balsa stick.

b. Drill .046" dia. holes through the edges of the Stabilizer at points V and W. Center the holes in the 1/8" balsa stick.

c. Cut a 14" long (unstretched) piece of elastic thread. Glue one end of the thread to the Tail Skid at point U. Run the other end through hole V on one side of the Stabilizer, then, through hole T at the top of the Fin, down through hole V on the other side of the Stabilizer, and finally, back to point U at the Tail Skid.

d. Cut a 9" long (unstretched) piece of elastic thread. Glue one end of the thread to the bottom of the fuselage at point S. Run the other end through hole W on one side of the Stabilizer, then through hole R at the top of the Fin, down through hole W on the other side of the Stabilizer, and finally back to point S on the bottom of the fuselage.

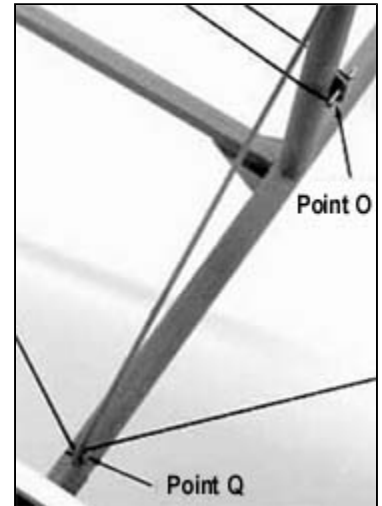

Note:

This is the extent of the rigging wires we've put on our Antoinette models. If you study photographs of the full-size Antoinettes, you'll discover that there are many more rigging wires that could be added using the elastic thread techniques. That's your option. Additional elastic thread is available wherever sewing thread is sold.



Pilot

111. Cut the parts of the printed cardboard pilot from the sheet with a sharp #11 hobby knife or scissors. Cut as accurately and close to the image as possible.

112. Drill a 1/16" dia. hole in the shoulder areas of the arms and body of the pilot. The locations for the holes are marked by a black dot.

113. Assemble the arms to the body using the #00-90 x1/8" long brass bolts, hex nuts, and washers that are provided.

114a Locate the two laser-cut plywood Control Wheels. Paint the Control Wheels with the colors of your choice (we used brown for the perimeter and steel for the spokes). Let dry.

b. Glue the Control Wheels in place on the fuselage (see top view plan). The left Control Wheel is glued right onto the elevator servo control arm. The right Control Wheel is mounted on the right fuselage side, with a small standoff cut from leftover 1/4" balsa dowel.

115a Cut a piece of 1/8" sq. balsa stick to fit between formers F6 and F7, at the top of the fuselage. Glue the stick in place, in the middle of the fuselage.

b. Glue the pilot to the stick. Bend the pilot's arms outward so his hands are on the Control Wheels.



Balance

As shown on the plans, your Antoinette should balance approximately 3-7/8" (34%) back from the leading edge of the wing, measured at the fuselage sides. We've achieved this balance point on all our prototype models, without having to add any additional weight, by mounting the battery pack on the forward BTM mount in front of former F3.

FLYING

Whether or not the Antoinette is your first indoor R/C model, we strongly suggest that you pay close attention to the following information! If you have access to an indoor basketball court or a clear gym space of about the same size, you can quickly get the take-off and landing procedures understood with little problem. If you don't have this kind of indoor space available, find a large paved surface outdoors, and remember you cannot fly this airplane in any kind of wind! In all of the following instructions, remember that altitude is best controlled with the throttle. As you gain experience flying the Antoinette, you will do this automatically. Finally, remember that the flight controls are on the right stick (for Mode II transmitters) and that trying to correct with "rudder" on the left stick will do nothing! This might seem a little obvious but if you are normally a 4-channel pilot, it can be a very real issue.

Taking off the Antoinette could not be easier. Simply throttle up smoothly (do not "punch it"), correcting the take-off run with a little rudder, if needed, and it will lift off by itself in a very short distance. Typical take-off runs for the Antoinette are about 6' - 10'. As soon as the airplane lifts off, smoothly throttle back the motor, **WITHOUT TURNING IT OFF**, allowing the airplane to lightly settle back down to the "runway" for a landing under power. All of this should be done in a straight line. Repeat this exercise enough times to become familiar with the way the airplane responds to throttle and your small control inputs. If you learn nothing else, learn this; the Antoinette will not continue flying with the motor off. With the motor off, it will almost immediately stop flying and drop to the ground. This characteristic is shared with the fullscale Antoinette, as well as most, if not all, early pioneer aircraft.

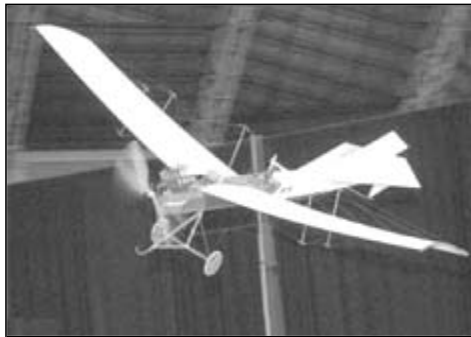
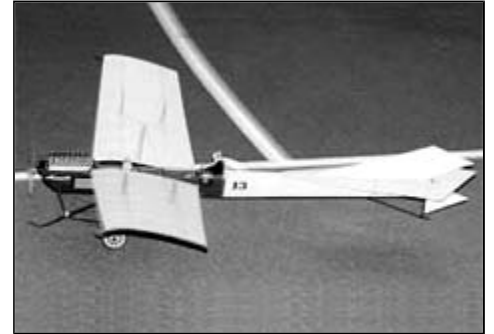

Once you've mastered the take-off and landing techniques, you're ready to fly the airplane. Take-off and use the throttle to establish a "cruise" altitude of about 6' to 8' in the air. Make the turns smooth, keeping the nose level or slightly down to avoid stalling and to maintain forward speed. This turning technique is very useful throughout the Antoinette's flight envelope. After making just a few turns, you'll realize that the control authority is remarkably smooth and sure, without being "twitchy". If flying indoors and the ceiling height permits, take the airplane up higher, using throttle to seek and then, hold any given altitude. This is a good exercise in learning how to fly this model. It won't be long before you're perfectly comfortable with this very nice flying scale model. Make a few low, slow passes and listen to your flying buddy's comments!

When you're ready to land, remember the landing technique that you practiced earlier - you must land under power! Set up for a landing by lowering the throttle setting just enough to let the airplane begin descending on its own. Line-up the final approach to take advantage of the longest part of your "runway", keeping the airplane straight while it settles to the ground under low power. Use elevator input only sparingly to avoid killing off too much forward speed and to flare very slightly immediately before touchdown. Turn the motor off, allowing the model to stop. On the smooth wooden floors of indoor gyms and basketball courts we've learned to "taxi" our Antoinette back to the flight station, using coordinated rudder and throttle inputs.

As you gain air time and experience, you'll be able to perform wingovers, touch and go landings, and of course, those lovely low, slow fly-bys. We've tried to loop the Antoinette many times but its relatively low speed, high-lift airfoil, and lack of mass tend to combine, making a loop nothing more than a powered stall. Hey, the full-scale Antoinette didn't loop either! Remember, we're talking 1909 - the first loop wasn't done with any airplane until 1913!

Finally, make it a habit to check over the airframe of your Antoinette after each flight. Check for any loose joints, etc. Bringing a little CA glue to your flying sessions is highly recommended for the first few outings.

CONCLUSION

We sincerely hope that building and flying your Antoinette has been a rewarding and interesting experience. We also hope that you now have a little better appreciation for the very real contributions that early aviation pioneers made in refining and furthering one of man's grandest dreams!

Want to learn more? During our research of the Antoinette and the other SIG Pioneers Of Flight models, we had a lot of fun reading related books for scraps of information and to find the occasional grainy black and white photograph of our subjects. One of the best books on these old aeroplanes is "Picture History Of Early Aviation, 1903-1913", by Joshua Stoff, published by Dover Publications 1996. It's probably the single best source of photos of the early aeroplanes, and it's still available new from book dealers.

Another very informative book was "CONTACT! The Story of the Early Birds", by Henry Serrano Villard, published by Bonanza Books, New York. Unfortunately, this book is no longer in print. We found our copy for sale on an internet used book search. If you love early aviation and want a good "read", complete with some great photographs, try to find a copy of your own! Last but not least, try to find a video copy of that great old movie "Those Magnificent Men And Their Flying Machines". It's a comic, yet historically well based, look at the great international air meets that started in 1909. It will show you what the Antoinette and many other early pioneer aeroplanes actually looked like in flight. It's fun to watch while you're building your own Antoinette.

Good luck and safe flying!

Hubert Latham and his record setting Antoinettes.
1909 - 1910

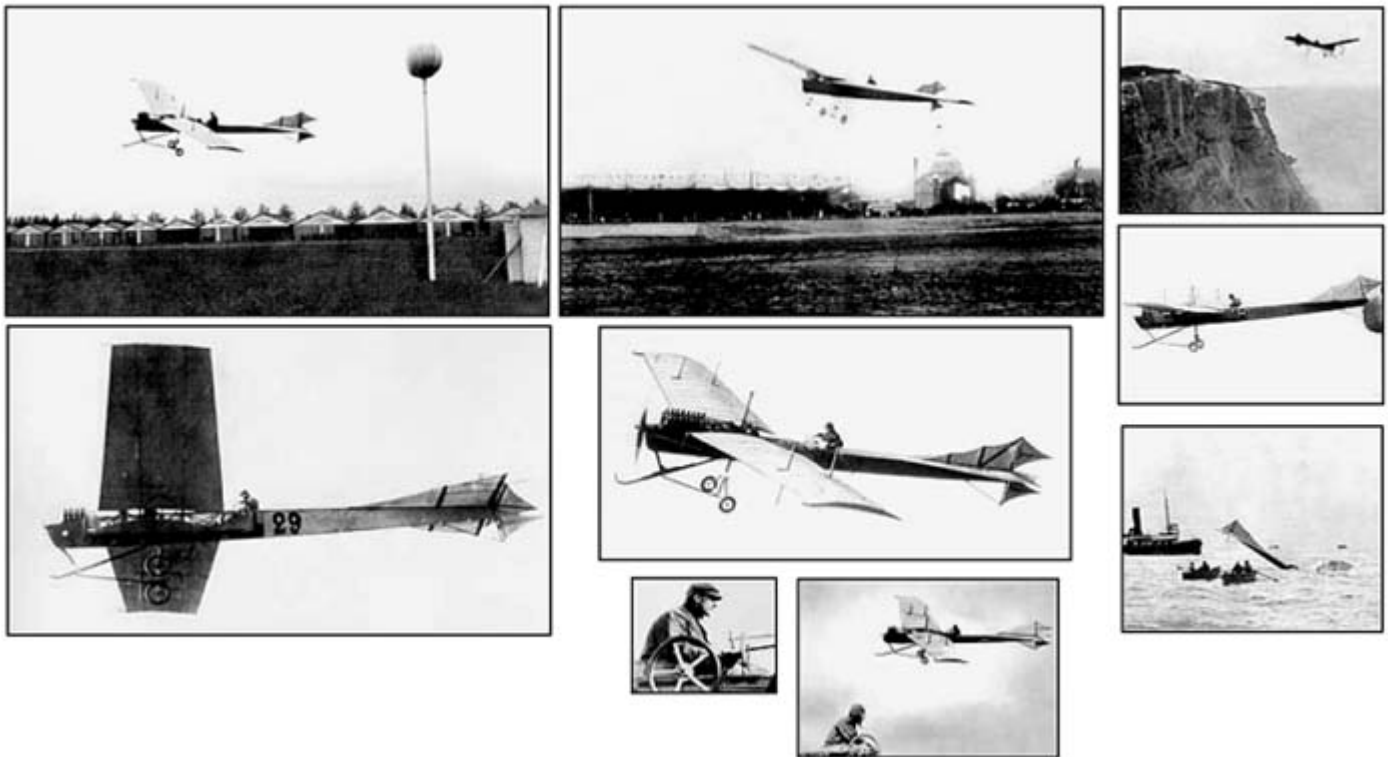

Antoinette replica built for the movie "Those Magnificent Man and Their Flying Machines".

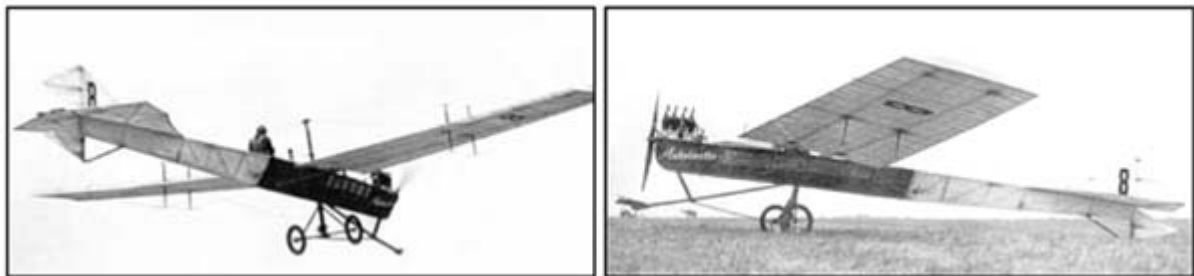

Customer Service

SIG MFG. CO., INC. is totally committed to your success in both assembling and flying the 1909 ANTOINETTE kit. Should you encounter any problem building this kit or discover any missing or damaged parts, please feel free to contact us by mail or telephone.

SIG MFG. CO., INC. 401-7 South Front Street Montezuma, IA 50171-0520	SIG MODELER S ORDERLINE: (to order parts)	1-800-247-5008
	SIG MODELER S HOTLINE (for technical support)	1-641-623-0215
	SIG WEB SITE	www.sigmfg.com

Antoinette

RIGGING DIAGRAM

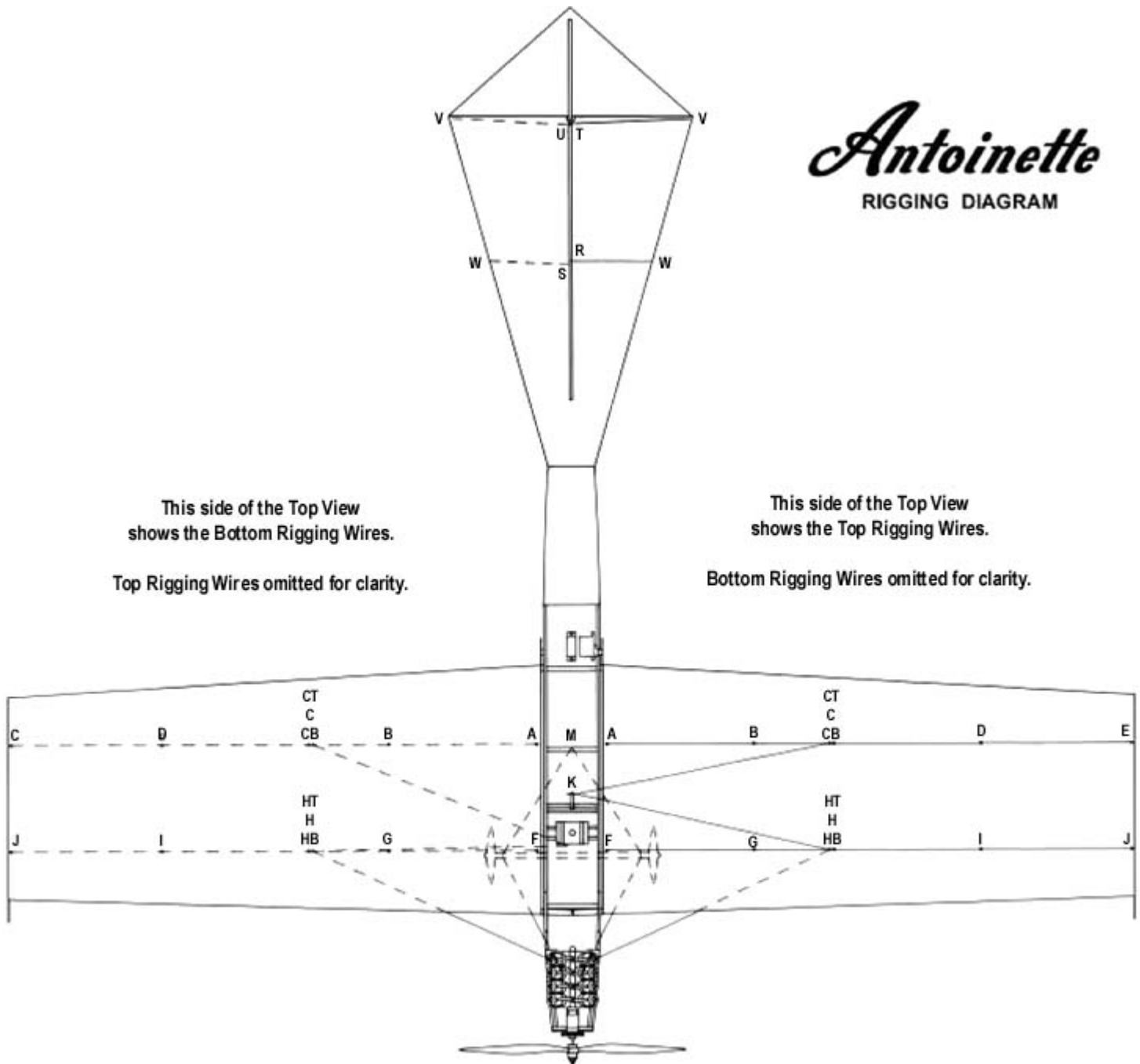

Warning! This is not a toy!

Flying machines of any form, either model-size or full-size, are not toys! Because of the speeds that airplanes must achieve in order to fly, they are capable of causing serious bodily harm and property damage if they crash. IT IS YOUR RESPONSIBILITY AND YOURS ALONE to assemble this model airplane correctly according to the plans and instructions, to ground test the finished model before each flight to make sure it is completely airworthy, and to always fly your model in a safe location and in a safe manner. The first test flights should only be made by an experienced R/C flyer, familiar with high performance R/C aircraft.

The governing body for radio-control model airplanes in the United States is the ACADEMY OF MODEL AERONAUTICS, commonly called the AMA. The AMA SAFETY CODE provides guidelines for the safe operation of R/C model airplanes. While AMA membership is not necessarily mandatory, it is required by most R/C flying clubs in the U.S. and provides you with important liability insurance in case your R/C model should ever cause serious property damage or personal injury to someone else. For more information, contact:

ACADEMY OF MODEL AERONAUTICS
5161 East Memorial Drive
Muncie, IN 47302
Telephone: (765) 287-1256

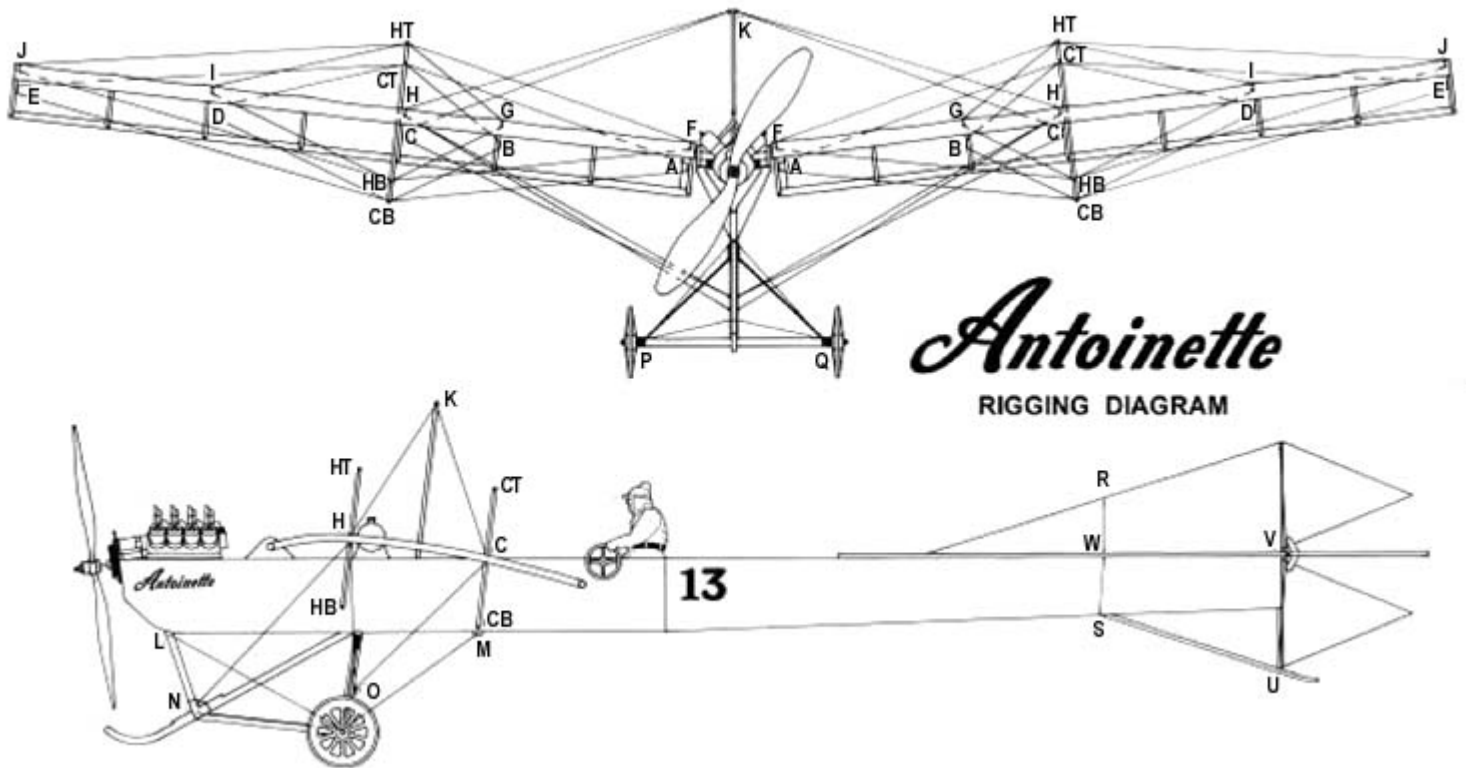

Antoinette
RIGGING DIAGRAM

© Copyright SIG Mfg. Co., Inc.

SIG MFG. CO., INC.....Montezuma, Iowa 50171-0520

LIMIT OF LIABILITY: The craftsmanship, attention to detail and actions of the builder/flyer of this model airplane kit will ultimately determine the airworthiness, flight performance and safety of the finished model. SIG MFG. CO's obligation shall be to replace those parts of the kit proven to be defective or missing. The user shall determine the suitability of the product for his or her intended use and shall assume all risk and liability in connection therewith.