

# SIG FAZER



## **BUILDING AND FLYING INSTRUCTIONS**



**Sig Mfg. Co., Inc...401-7 South Front Street...Montezuma, Iowa 50171**

### **Designing The Fazer by Mike Pratt**

OK I admit it! After flying a number of fun fly models I was hooked on them. In addition to flying R/C I also like to fly control-line models and this kind of "In Your Face" flying seemed perfect for me, as well as for a lot of other people out there. Little did I know this would lead me to designing my next kit.

After talking (hanger flying) to a number of prominent modelers, we all came to the same three conclusions,

1. Most fun fly models don't perform enough adrenaline pumping maneuvers. Sure they did lightning fast rolls, super loops, and could take-off and land in a tennis court, but what about some of the other maneuvers, like real snap rolls, knife edge flight, and true spins?
2. The ground handling characteristics of these models leaves a little to be desired. Most of them look like a bunch of drunk ducks walking around.
3. One other thing we all agreed on was "They Are Butt Ugly!" They all look like a Hershey bar stuck on a popsicle stick and because they are full of carbon fiber, they are quite expensive too.

After thinking about it for a while, the light went on - I'll make it look like Leo Loudenslagers world famous Bud Light Laser, the most recognized aerobatic airplane of all time! I will give it a good looking super strong double tapered wing that is 2 1/2" thick at the root, a light one piece routed balsa profile fuselage that's easy to build, a two wheel main landing gear, and a steerable tail wheel for great ground handling, and build it entirely out of Sig quality balsa and plywood. Neat huh!

When the first prototype model was finished and test flown I was more than just pleased, I was ecstatic. The flight performance was more than I had hoped for. Here was a great looking model that not only performed super fast rolls, tight loops, and quick take-offs and landings, but also did really neat snap rolls, horizon to horizon knife edge flight, quick crisp spins, and many other exciting maneuvers.

The kit was carefully engineered with the help of CAD (Computer Aided Drafting) drawn plans and CAD generated tooling, so the modeler would spend less time in the work shop and more time flying. Many conveniences were incorporated into the kit to reduce the building time (i.e. routed balsa profile fuselage, die-cut wing ribs with alignment tabs, die-cut plywood doublers, pre-formed aluminum landing gear, many pre-cut balsa parts, and a complete hardware package.) The number of parts in the kit were kept to a minimum without sacrificing the quality or complicating this easy to build kit. All of these conveniences were deemed necessary to quickly move the modeler from the work bench to the flying field.

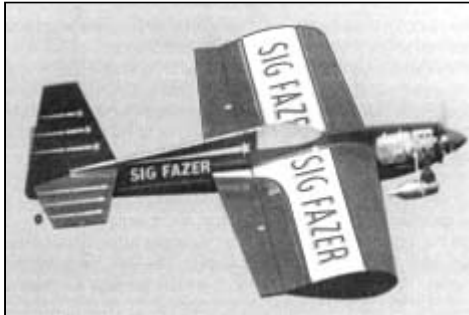
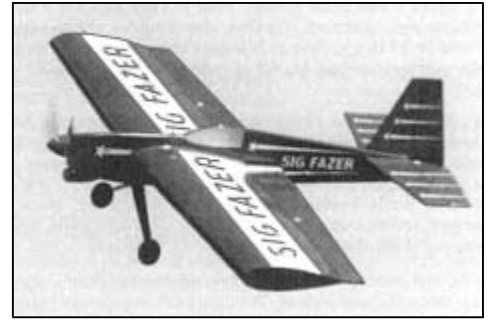

## Engines, Propellers And Mufflers

The recommended engine range for the FAZER is .25 to .40 cu. in. 2-stroke engines or .40 to .50 4-stroke engines. There are a tremendous variety of engines available in either type. Each engine type has it's own advantages and disadvantages. The 2-stroke engines are light and powerful but are usually louder and have to turn a smaller diameter prop. The four stroke engines are somewhat heavier than the 2-stroke engines, but they are almost always quieter. They turn a much larger diameter prop that delivers more thrust. The modeler must be extremely careful not to over rev the 4-stroke engines during maneuvers.

Selecting the proper size of propeller for your particular engine is a very important part of the whole set up. The FAZER, like most fun fly models, was designed to use low-pitch props. What we want is climb and vertical performance, not straight line speed. Use the prop selection chart listed.

Use an effective muffler! A loud muffler may cost you (and possibly your club) the use of your flying field if it annoys a non-flying neighbor. Use the muffler that came with your engine or one of the after-market mufflers that are available.

Engine Size	Prop Diameter	Prop Pitch
.25 to .28 cu. in. 2-stk	9" to 10" dia.	4 to 5 pitch
.30 to .40 cu. in. 2-stk	10" to 12" dia.	3.5 to 4 pitch
.40 to .50 cu. in. 4-stk	12" to 13" dia.	4 to 4.5 pitch
<b>Do not use 10x6 or 11x6 props</b>		

## Radio Equipment Requirements

Your FAZER will require at least a four-channel radio system with five standard size servos to operate the ailerons, elevator, rudder, and throttle. To take full advantage of the flight performance of the FAZER a radio system with mixing capabilities is preferred. By mixing a number of channels together you can greatly enhance the maneuverability of your FAZER. A good example would be coupling the elevators to the flaps. When coupled, the elevators go up and the flaps go down, (and vice versa) giving the model the ability to make really tight turns or loops. Another example is hooking up the flaps to a three position switch on your transmitter. With the switch in the No.1 position, the flaps are kicked up about 10 degrees. This acts like spoilers on a sailplane giving the model a faster descent for landings. With the switch in the No.2 position, the flaps are in the neutral position. With the switch in the No.3 position the flaps are lowered to about 30 degrees for a nice slow approach to a landing.

Be certain that your radio system's frequency is approved for use in R/C model aircraft. Using a frequency assigned to R/C model cars and boats not only endangers your model to interference from model car and boat drivers (who may not even be in sight), it is also against the law.

## You Can't Get Along Without A Good Sanding Block

An assortment of different size sanding blocks are indispensable tools for model construction. A good general purpose block can be made by wrapping a 9"x11" sheet of sandpaper around a piece of hardwood or plywood. Use three screws along one edge to hold the overlapped ends of the sandpaper. Put 80-grit paper on the block during general construction. Switch to 220-grit paper for final finish sanding just before covering.

In addition to the large block, there are places where a smaller one is handy. Also a sandpaper "file" can be made by gluing sandpaper to a flat spruce stick or around a hardwood dowel for working in tight places.

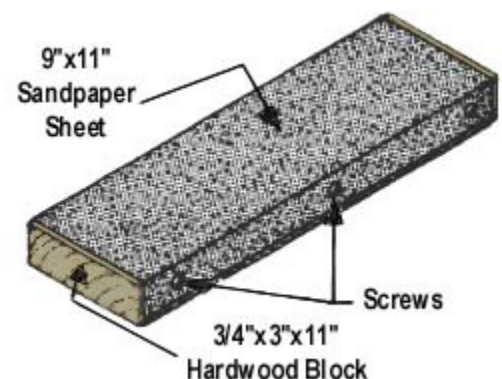

## Glues

There are many different glues available today for model construction that it can be confusing to even the experienced modeler. To simplify matters, most glues can be classified as one of four basic types: Fast cyanoacrylate adhesives (abbreviated as CA) such as Sig CA, easy to use water-based wood glues such as Sig-Bond (yellow) and Sig Super-Weld (white), super strong (but heavier) two-part epoxy glues such as Sig Kwik-Set (5 minute cure) and Sig Epoxy (3 hour cure), and traditional solvent-base model cements such as Sig-Ment.

Each of these types has different characteristics and advantages. Often times, the choice of which type to use is strictly a matter of personal preference based on your experience with previous models. CA is recommended as our first choice because of its ability to penetrate an already assembled joint. In other words, parts can be assembled dry (without glue), the alignment checked and adjusted, and then the glue can be applied to the joints. You should also have on hand some epoxy (both 5-minute and slow dry) and Sig-Bond because these glues are called out in several of the steps in these instructions.

Sig CA, like most brands of cyanoacrylates, come in three viscosities- thin, medium, and thick. Odorless CA is generally more expensive, but it is ideal for people who can't tolerate the fumes of normal CA. An accelerator spray and debonder are also available and are described below.

- **Sig CA Thin-** Watery consistency, thin CA should only be used when the two parts to be joined are in perfect contact with zero gap. Capillary action pulls this glue deep into the wood resulting in a very strong bond and it dries in just a few seconds. Thin CA can be used to tack assemblies together, but these joints should be glued again later with medium or thick CA. Thin CA is also necessary for installing Easy Hinges.
- **Sig CA Plus-** Our medium thickness CA is excellent for almost any step during construction. The extra thickness allows the glue to fill small gaps, but it does dry a little slower than a thin CA.
- **Sig CA Slow-** This thickest formula is good for filling large gaps and building up strong fillets at joints requiring extra strength. It also dries slow enough to allow you to apply it to one part and position it on another before it dries. This feature is useful when laminating large sheeted areas like a fuselage side and a fuselage doubler.
- **Sig Kwik-Shot Accelerator-** Spraying accelerator on CA (any thickness) will cure it almost instantly. Although CA is fast, it's sometimes nice to speed it up even more.
- **Debonder-** This can be used to separate parts, but you'll probably use it for unsticking your fingers more than anything else!

**CAUTION:** Some people have experienced allergic reactions when exposed to epoxy or cyanoacrylate glues. This is very rare. However, it is always important that such glues, and also paints, thinners and solvents, be used with adequate ventilation to carry fumes away.

### COMPLETE KIT PARTS LIST

#### Die-Cut Balsa Sheets

1	3/32"x3"x12" Sheet No.1 W-1A & W-1B Wing Ribs	2	3/32"x4"x15" Sheet No.2 W-2 & SR-2 Wing Ribs	2	1/16"x4"x18" Sheet No.3 W-3 & W-8 Wing Ribs	2	1/16"x4"x18" Sheet No.4 W-4 & W-7 Wing Ribs
2	1/16"x4"x18" Sheet No.5 W-5 & W-6 Wing Ribs	2	3/32"x4"x15" Sheet No.6 WT & SR-1 Wing Ribs				

#### Sheet Balsa

4	1/16"x4"x24" Leading Edge Sheeting	4	1/16"x4"x12" Center Section Sheeting	4	1/16"x1"x24" Trailing Edge Sheeting		
---	------------------------------------	---	--------------------------------------	---	-------------------------------------	--	--

#### Stick Balsa

4	1/4"sq. x11" Wing Spar Doublers	4	1/4"sq. x24" Wing Spars	2	1/4"sq. x24" Fin & Rudder	9	1/4"x3/8"x24" Elevator & Flap Leading & Trailing Edges
3	3/16"x 1/4"x24" Elevator & Flap Cross-Bracing	3	1/16"x1/4"x24" Wing Rib Cap Strips	2	3/8"sq. x24" Wing Leading Edge	2	1/4"x3/8"x24" Wing Trailing Edge

#### Special Cut Balsa

10	3/32"x4"x2" Wing Shear Webbing	2	1/4"x1"x4" Rudder Top & Bottom	1	1/4"x1 1/2"x4" Stabilizer Center Section	2	1/4"x2"x2" Throttle Servo Mount & Elevator Gussets
1	1/2"sq. x4" Fuselage Fill-In	1	1/2" Routed Profile Fuselage				

#### Laser Cut Birch Plywood

1	1/8"x2"x9" Wing Joiner	1	1/8"x5"x14" Left Fuselage Doubler	1	1/8"x5"x14" Right Fuselage Doubler		
---	------------------------	---	-----------------------------------	---	------------------------------------	--	--

#### Die-Cut Plywood

1	1/8"x3"x6" Lite Ply Servo Mount	1	1/32"x5"x8" Birch Plywood Servo Hatch Covers				
---	---------------------------------	---	--	--	--	--	--



<b>Hardwood</b>							
2	3/8"x1/2"x5 3/4" Maple Engine Mounts	8	1/8"x1/4"x1" Spruce Servo Reinforcements	4	1/8"x1/4"x3 5/8" Spruce Servo Hatch Reinforcements		
<b>Wire Parts</b>							
1	3/32" dia. Pre-formed Elevator Joiner	1	1/16" dia. Pre-formed Tailwheel Wire	2	1/16" dia. x24" Elevator & Rudder Pushrods	2	2-56 x10" Threaded Aileron Pushrods
1	.065 dia. x12" Braided Cable Throttle Pushrod						
<b>Molded Nylon Parts</b>							
1	Small Left Nylon Control Horn	1	Small Right Nylon Control Horn	2	Medium Right Nylon Control Horns	2	1/8" dia. Nylon Clips for Pushrod Guides
1	1/8"o.d.x24" Nylon Tube for Antenna	1	1/8"o.d.x12" Nylon Tube for Throttle & Pushrod Guides	1	1/8" Molded Nylon Engine Mount	4	2-56 Nylon RC Links
1	Molded SIG E-Z Connector Retainer						
<b>Hardware</b>							
5	2-56 Solder Links	2	2-56 Threaded Brass Couplers	8	No.2 x3/8" Sheet Metal Screws	2	No.6 Flat Washers
4	4-40 J-Bolts	4	4-40 Blind Nuts	3	4-40 x1 1/2" Round Head Bolts	4	4-40 x1/8" Socket Head Bolts
1	4-40 x1/8" Socket Head Bolt	2	6-32 x 1 1/2" Round Head Bolts	2	2-56 x1" Round Head Bolts	4	6-32 Hex Nuts
3	4-40 Locking Hex Nuts	2	2-56 Hex Nuts	15	SIG Easy Hinges	1	1"x14" Glass Tape
1	SIG E-Z Connector	1	1/2"x6" Servo Tape				
<b>Miscellaneous Parts</b>							
1	.090 Left Aluminum Landing Gear	1	.090 Right Aluminum Landing Gear	3	8"x27" Decals	1	38"x50" Plan
1	28 Page Photo Illustrated Instruction Book						

Laser Cut 1/8"x5"x14" Birch Plywood (1 req.)

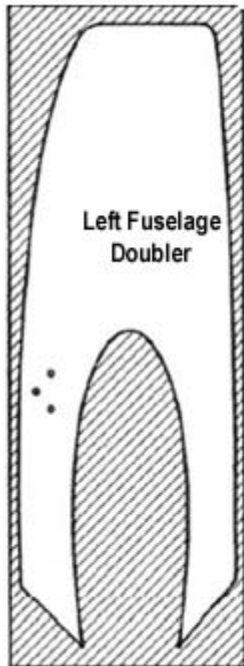

Die Cut 1/8"x3"x6" Lite-Ply (1 req.)

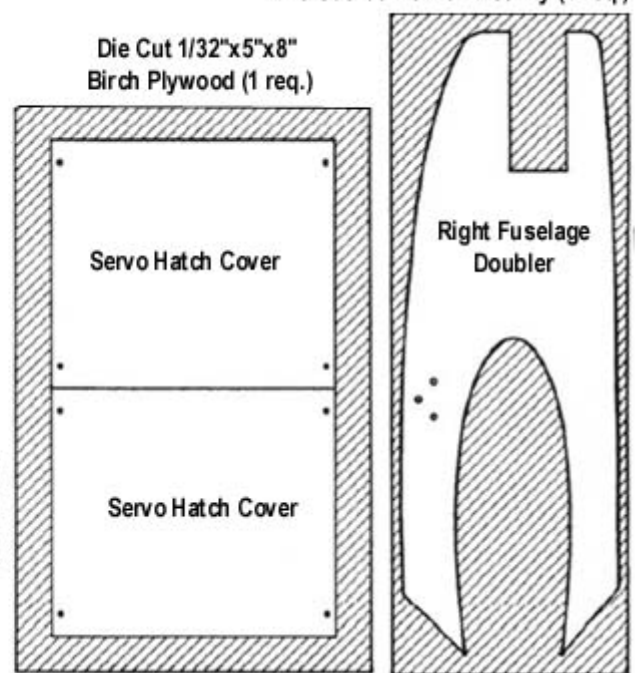

### KEY TO PLYWOOD PARTS

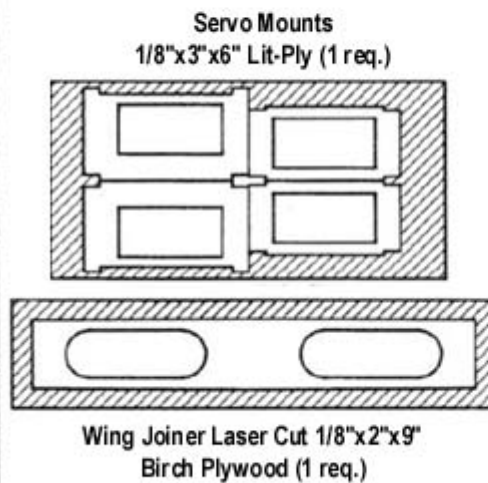

## Notes Before Beginning Construction

Any references to right or left refers to your right or left as if you were seated in the cockpit.

To build good flying models, you need a good straight building board. Crooked models don't fly well! The building board can be a table, a workbench, a reject "door core" from the lumber yard, or whatever - as long as it is perfectly flat and untwisted. Cover the top surface of the building board with a piece of celotex-type wall board or foam board, into which pins can be easily pushed. Don't hesitate to use plenty of pins during assembly to hold drying parts in their correct position.

When pinning or gluing parts directly over the full-size plans, cover the plan with wax paper or plastic kitchen wrap to prevent gluing the parts to the plans.

Don't use a ball point pen for making marks on the model during construction. If not sanded off these ink marks will show through the model's final finish. Use a pencil instead of a pen.

Leave all the die-cut parts in the sheets until needed for construction. Then remove pieces from the sheets carefully. If difficulty is encountered, do not force the part from the sheet. Use a modeling knife to cut it free.

The die-cut balsa and plywood can be identified using the plans and the "Key to Die-Cut Parts" above. Mark the identification numbers on the corresponding parts before removing them from the die-cut sheets

All of the other parts can be identified by the "Complete Kit Parts List". Sort the different sizes of sticks and sheets into individual piles to avoid confusion during building.

## About The Building Sequence

The quickest and most efficient way to complete a model is to work on several pieces at the same time. Example: While the glue is drying on the wing, you can start on or proceed with the fuselage (or other components). The building sequence used in these instructions is the best way to build each of the major components of the model. Plan ahead! Read the instructions completely and study the full size plans before beginning construction.

## WING CONSTRUCTION

---

### A Note To The Modeler Before Beginning Construction:

The full size plan shows the bottom view of the FAZER wing (as if it was viewed from the bottom of the model.) This was necessary to show the proper location of the elevator and rudder servos and associated ribs and servo mounts. The wing is built upside down (bottom up) over the plans and is not removed from the building board until step No.30.

1. Begin the wing construction by laminating four 1/4"sq. x11" balsa doublers to four 1/4"sq. x24" wing spars as pictured in the photo. Note: If the 1/4"sq. x24" spar is warped, glue the 1/4"sq. x11" balsa doubler to the inside of the warped or concave side of the balsa spar. Place the 24" spar against a straight edge before gluing to assure a straight spar.
2. Cut-out the Spar Angle Guide and glue it to a piece of stiff cardboard. Use the Spar Angle Guide and a soft lead pencil to mark the correct angle, (make sure the angle goes towards the balsa spar doubler) on the end of the four wing spars. Carefully angle the end of the wing spars with a sanding block.
3. Drill a 1/8" diameter hole in the small dimple just behind the spar notches in one set of wing ribs (W-2 through W-8) for the nylon antenna tube. Use this set of ribs to make up the left wing panel.

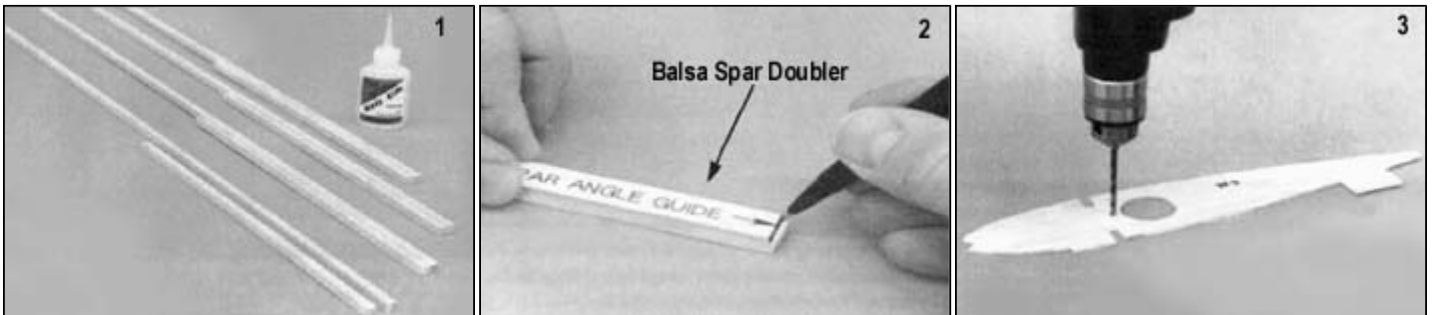
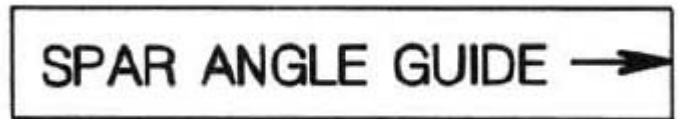

4. Pin a piece of scrap 3/32" balsa over the plan at the wing spar and the center wing rib W-1A. Use a soft lead pencil and draw a center line in the scrap of balsa as shown in the photo, this is where the two spars are joined together. Cover the scrap of balsa with a small piece of wax paper.
5. Pin one of the laminated wing spars in place making sure that the laminated end of the spar is lined up with the center line on the balsa scrap and that the spar doubler is on the top.

6. Pin the W-8 wing rib in it's proper location over the plan. Use a scrap piece of 1/4" sq. balsa to block up the spar as shown in the photo. Tack glue the wing spar to the W-8 wing rib with thin CA glue.

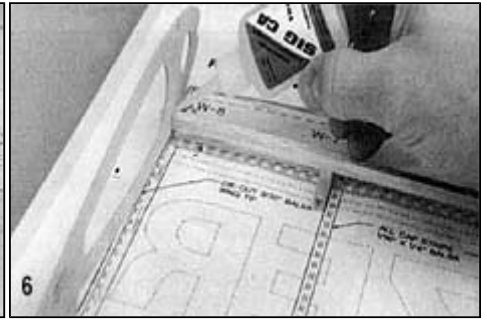
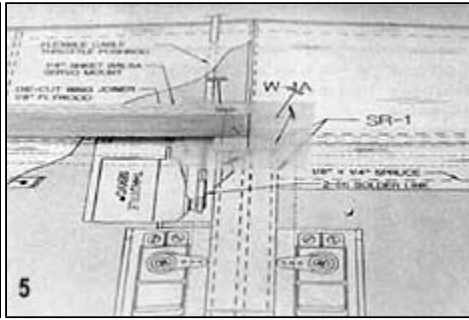
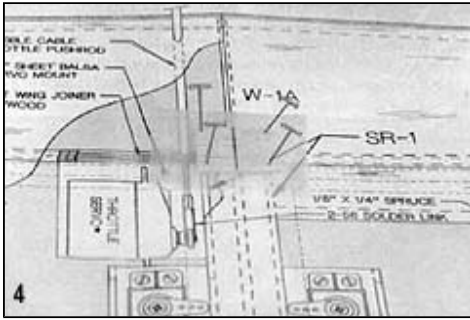

7. Repeat the above steps No.5 and No.6 for the opposite wing panel.
8. Pin in place the remaining ribs in each wing panel W-2, W-3, W-4, W-5, W-6, and W-7.

Note: **Do not glue ribs in place at this time.** Make sure the wing spars are fully seated into the spar notches in each of the wing ribs and each rib is pinned to the building board.

9. Drill a 1/8" dia. hole in the 1/8" plywood wing joiner for the throttle pushrod tubing. There is a small dimple in the joiner to mark the correct spot for the hole.
10. Mark the center of the plywood joiner with a soft lead pencil. Glue the plywood wing joiner in place. Make sure the plywood wing joiner is centered front to back (in the middle of wing spars) when viewed from above.

**BUILDERS TIP:**

When pinning the ribs to the building board, always run the pins through both alignment tabs on each of the ribs.  
Example: Pass one pin through the front tab at a 45 degree angle from the right side and one through the rear tab at 45 degrees from the left side.

This keeps the rib in contact with and square with the building board during construction.

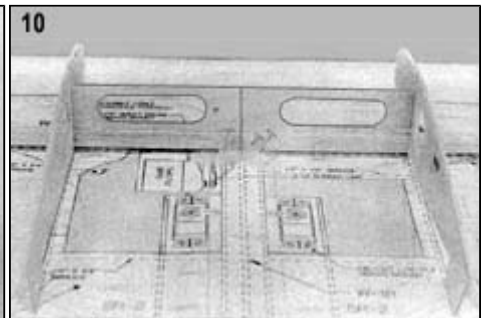
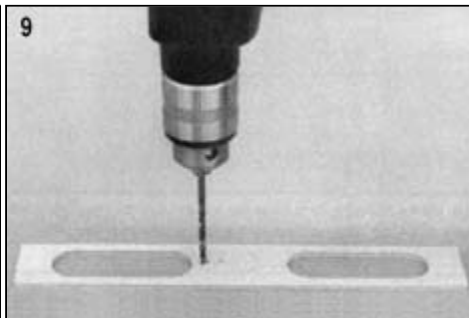
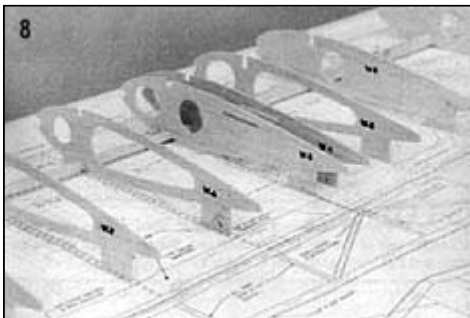

11. Apply a coat of slow CA glue to the top of the plywood wing joiner and install the two remaining spars. Again, make sure the spars are seated fully into the notches of the wing ribs. Also make sure the ends of the laminated wing spars line up with the center line previously marked in the plywood wing joiner.
12. Make sure all the wing ribs are square to the building board and to the wing spars. Glue the wing ribs to the spars with a thin CA glue.
13. The back of the wing rib W-1A and the front of W-1B fit between the wing spars and flush to the plywood wing joiner. (Refer to the plan) Pin and glue in place the center ribs W-1A and W-1B.

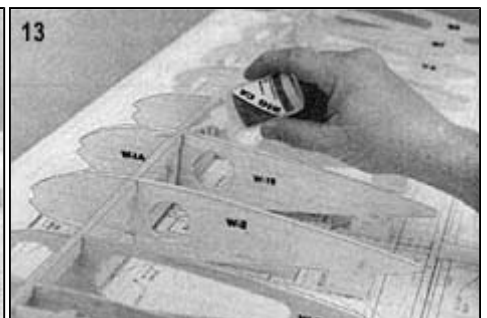
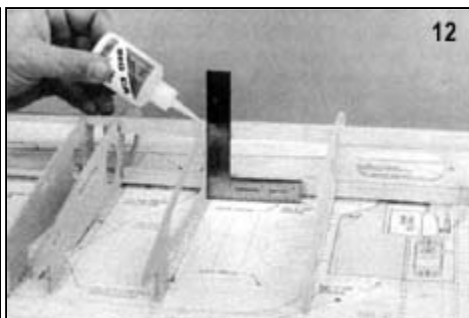
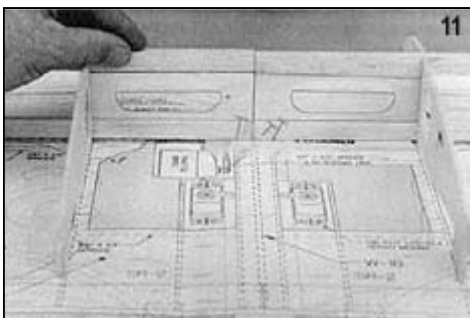

14. As in the previous step, the front of the sub ribs SR-1 also fits between the wing spars and flush to the plywood wing joiner. Pin and glue in place the sub ribs SR-1.
15. Four 1/16"x1"x24" balsa sheets have been provided for the trailing edge sheeting. Pin and glue two of the balsa sheets to the bottom of the wing ribs, joining them together at the center of the wing rib W-1B. Make sure the sheeting is flush with the ends of the ribs. Glue the remaining two 1/16"x1"x24" balsa sheets to the top of the wing ribs at the trailing edge in the same manner. If needed, sand the sheeting and the ends of the ribs with a long sanding block in preparation for gluing the 1/4"x3/8" balsa trailing edge on.
16. Glue and pin in place the two 1/4"x3/8"x24" balsa trailing edges to the rear of the wing ribs and trailing edge sheeting as per the photo.



17. Pin and glue in place the two 3/8"x24" balsa leading edges to the front of the ribs. Slightly bevel one end of the two leading edges to achieve a flush fit between them when they are joined together at the center rib W-1A.
18. Ten pieces of 3/32"x4"x2" balsa have been provided for the wing shear webbing. Trim fit and glue in place the balsa shear webs at the locations shown on the plans. Make sure that the shear webs are located in the center of the spars. The strength of the wing depends on the wing shear webbing. Do not be stingy with the glue when you add the shear webs. At least two coats are required.
19. Place a strip of masking tape on each side of the wing spar to protect the wing ribs and carefully trim the spar to match the contour of the wing rib. Start out by using a small block plane to roughly trim the spar and then switch to a sanding block for final shaping.  
Note: Extreme care must be taken so as not to distort the airfoil shape. Repeat the above step for the opposite wing panel.



20. Four 1/16"x4"x24" balsa sheets have been provided for sheeting the leading edges. Carefully trim one end of each of the leading edge sheets to its proper angle as shown in the photo. This angle is where the sheets are joined together at the center of the wing rib W-1A.  
Note: If necessary, trim the leading edges of the balsa sheets to allow the sheet to fit flush on the 3/8" sq. leading edge.



21. Glue the leading edge sheeting to the 3/8" sq. balsa leading edge as shown in the photo. Use pieces of masking tape to help hold the sheeting in place until the glue cures.
22. Using a long straight edge and a modeling knife, trim off the excess leading edge sheeting parallel to and at the back of the wing spar.



23. Using a slow setting CA glue or Sig Bond, lift up the wing sheeting and apply a coat of glue to the top of each rib and along the wing spar.

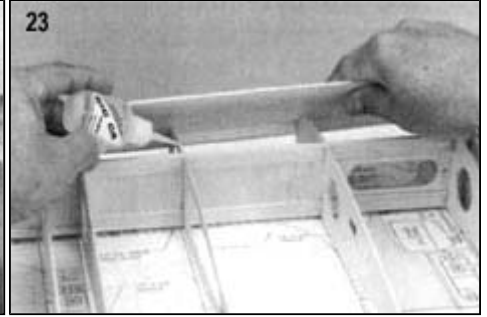
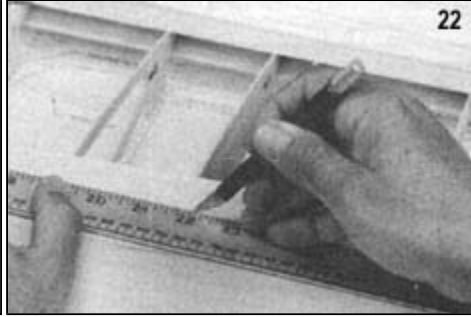
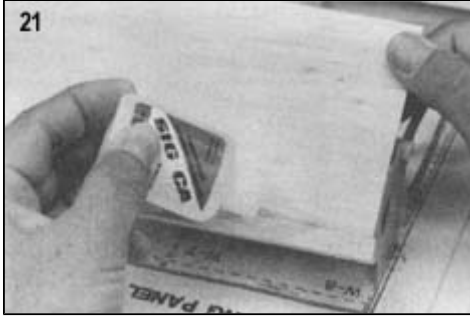

24. Working from the leading edge back to the spar, pin the sheeting in place and allow to dry.

25. Repeat steps No.19 to 24 to sheet the leading edge of the opposite wing panel.

26. Four 1/16"x4"x12" balsa sheets have been provided for sheeting the center section (two sheets for the top and two sheets for the bottom.) The balsa fillets that curve out to the leading and trailing edge are optional. The modeler can cut the balsa sheets flush with the outside of the wing rib W-2. However, we think they really look neat and are worth the extra effort. Cut out the Fillet Pattern and glue to a stiff piece of cardboard. Place the Fillet Guide on the ends of the 1/16"x4"x12" balsa sheets and cut-out the fillets with a modeling knife. Glue and pin the center section sheeting in place as shown in the photo.

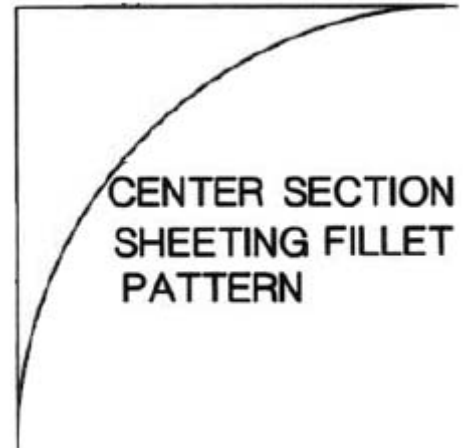

27. Glue two of the 1/8"x1/4"x1" spruce reinforcements to the back of the die-cut Lite-Ply aileron servo mount as shown in the photo.

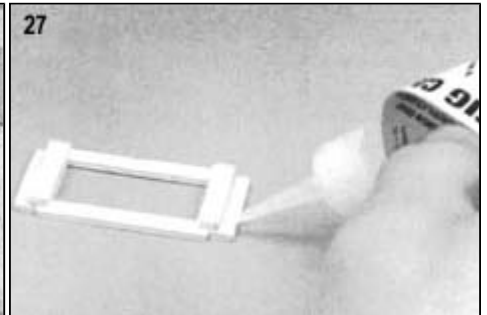
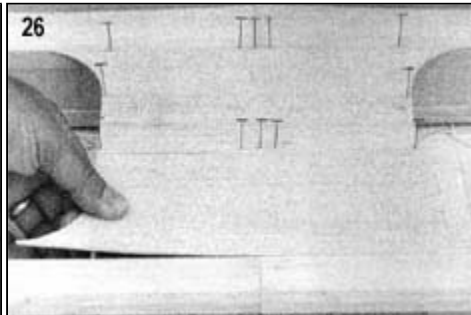

28. Install the die-cut aileron servo mount between wing ribs W-4 and W-5 by twisting the servo mount until the tangs of the servo mount snap into the wing rib slots. Make sure the spruce reinforcements are to the inside of the wing. Securely glue the servo mount to the wing ribs with CA glue.

29. Cut to length and glue in place the 1/16"x1/4" balsa rib caps. Make sure the rib caps are glued to the ribs and are not allowed to pull away from the ribs.

30. Glue in place the two 1/16"x1/4" balsa strips between the wing ribs W-4 and W-5 as shown on the plan and in the photo.

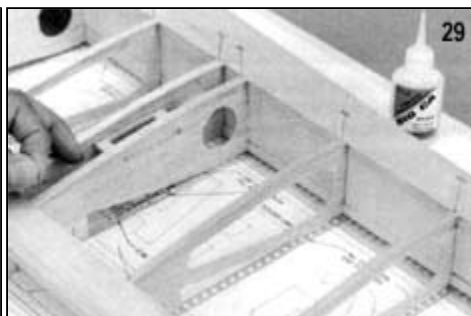
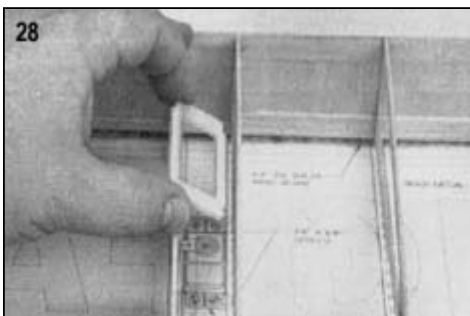



The bottom of the wing is now nearly completed. Cutting out the servo hatch openings will be done in a later step. Remove the wing from the building board and turn it over. Pin the trailing edge in place over the plans. Block up the wing with balsa blocks placed under the wing spars. Again, make sure that the trailing edge is absolutely straight.

31. Glue the die-cut Lite-Ply servo mount to the sub-rib SR-2 making sure that you make one left and one right as pictured in the photo.
32. Glue in place the 1/8"x1/4"x1" spruce servo reinforcement to the back side of the die-cut Lite-Ply servo mount.
33. Install the assembled sub-rib SR-2 and servo mount into it's proper location as shown on the plan. Make sure that the tang on the servo mount snaps into the slot in the sub-rib SR-1. Securely glue SR-2 and the servo mount in place with CA glue. Repeat this step for the other side.

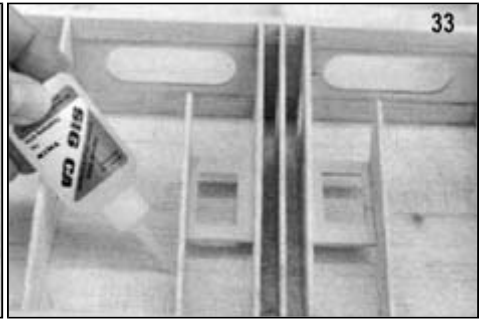
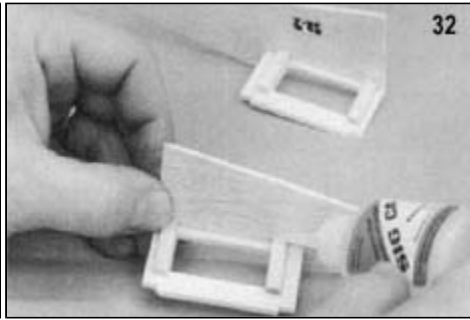
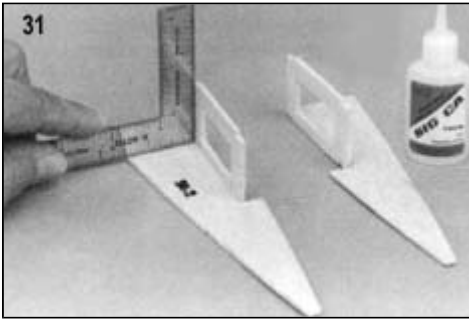

34. Carefully cut away the alignment tabs on each rib with a modeling knife. Smooth up any rough edges on the ribs with a sanding block. Make sure you do not distort the shape of the airfoil.

35. Repeat step No.19 to trim off the top of the spars on this side of the wing.

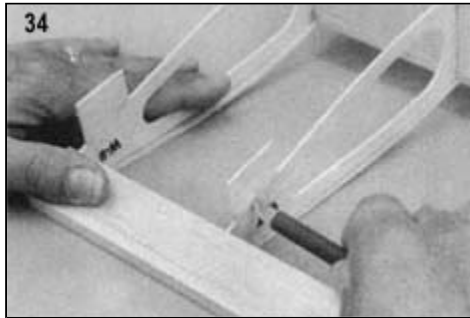

36. Repeat steps No.21 to No.24 to sheet the other leading edges.

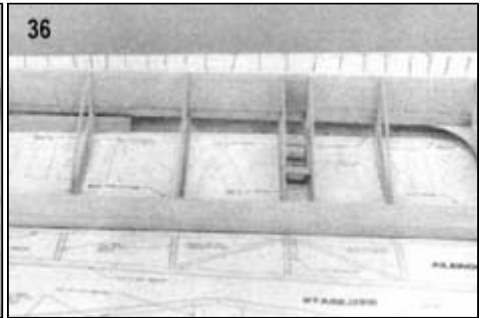

37. Repeat step No.26 to sheet the center section of the wing.

38. Repeat step No.29 to install the rib cap strips. Now you can remove the wing from the building board.

39. Use a long sanding block and sand the 1/4"x3/8" trailing edge down to match the trailing edge sheeting. Take your time during this step and make sure you do not sand too much and distort the airfoil shape.

40. On each wing tip cut off excess leading and trailing edge sheeting, balsa spars, and balsa leading edge with a razor saw so that they are flush!

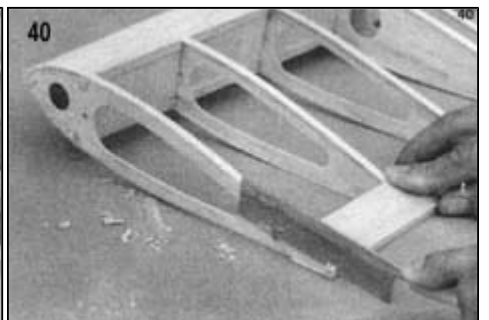
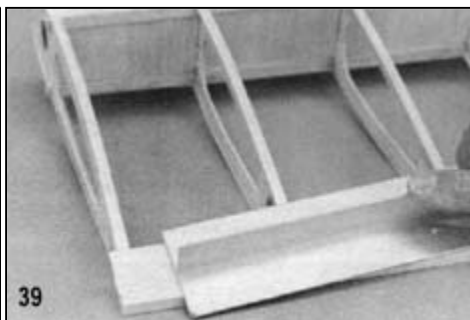
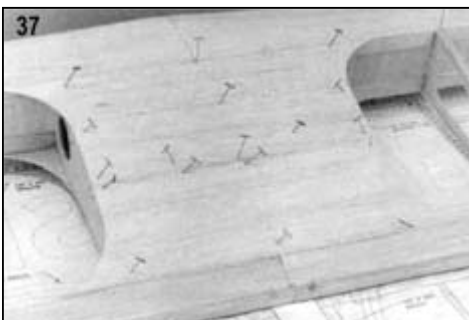

41. Glue and pin in place the wing tips (WT) on the outside of the W-8 ribs and allow to dry. Drill a 1/8" hole for the nylon antenna tube to pass through the wing tip (WT) in the left wing panel.

42. Using the measurements that are shown in the photo, mark and cut out the servo hatch openings in the bottom of the wing center section sheeting.
43. At the leading edge side of the hatch, glue in place the 1/8"x1/4"x3 5/8" spruce hatch reinforcement to the inside of the wing sheeting as per the photo.

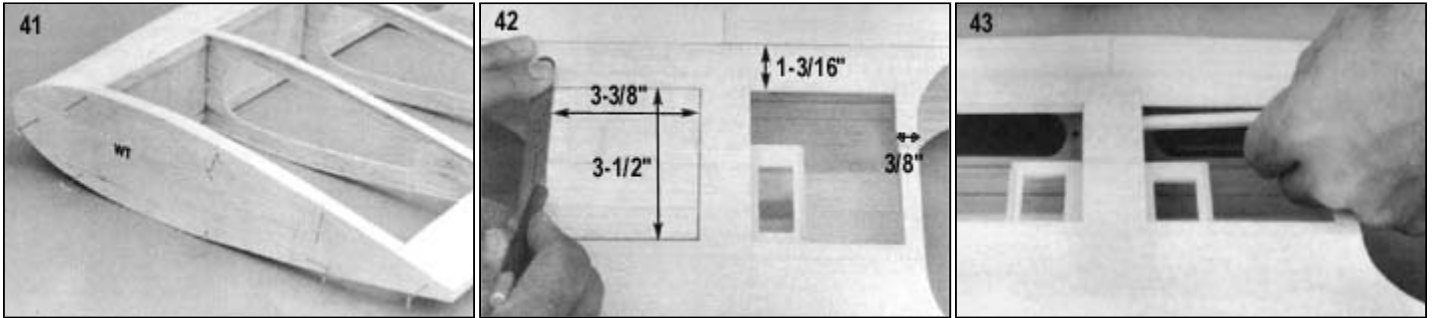

44. At the trailing edge side of the hatch, the spruce reinforcement must be cut into 2 pieces, one 2 1/4" and the other 1 1/4". Glue the 2 1/4" spruce reinforcement to the inside of the wing sheeting between the W-2 rib and SR-2 rib. Glue the 1 1/4" spruce reinforcement to the inside of the wing sheeting between the SR-1 rib and the SR-2 rib as detailed on the plans.

45. Slide the nylon antenna tube through the previously drilled holes in the ribs. The nylon antenna tube ends just inside the W-2 rib as shown on the plan. Cut off any excess nylon tube flush with the outside of the wing tip (WT) and glue in place with thin CA glue at every rib.

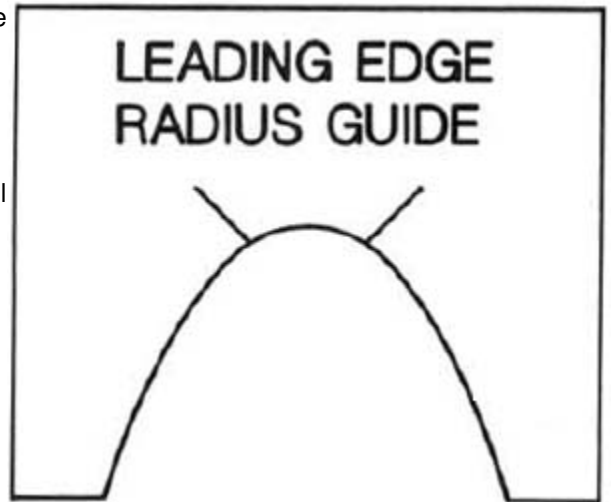

46. Lay a strip of masking tape on the wing sheeting along the seam between the 1/16" sheeting and the 3/8" sq. leading edge. Use a small razor plane and roughly carve the 3/8" sq. balsa leading edge, do not carve the 1/16" sheeting.

47. Remove the masking tape from the sheeting when the leading edge shape is close. Cut-out the leading edge radius guide and glue it to a stiff piece of cardboard. Finish shaping the leading edge with a sanding block periodically checking the leading edge with the guide. The Fazer wing has a constant radius leading edge from the root to the tip. Use the guide along the entire leading edge to achieve proper shape.



48. Temporarily install the elevator and rudder servos. Use a 1/16" drill bit and pin vise to drill holes in the Lite-Ply servo mount for the servo mounting screws.

49. Again using the 1/16" drill bit and the pin vise, drill four holes in the 1/32" plywood hatch covers by using the small dimples in each corner of the hatch to locate the holes.

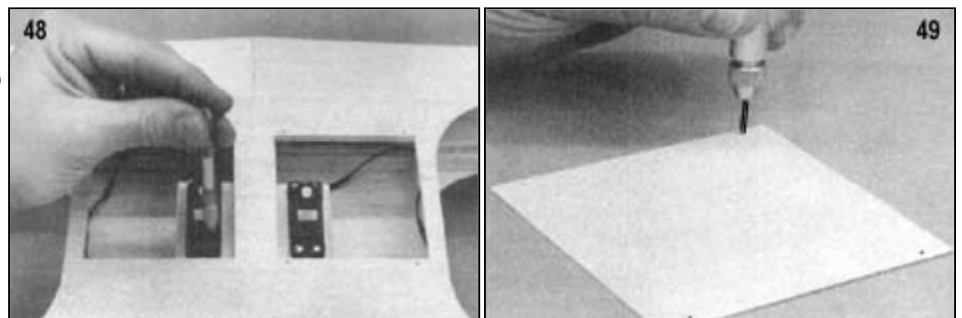

50. a. Mark the location of the output shaft by placing the hatch over the opening as shown in the photo and marking the location of the servo output shaft.
- b. Next, move the hatch cover to the top of the opening and mark again. Extend the lines to each other and drill a 3/8" dia. hole at that intersection in the plywood hatch cover.

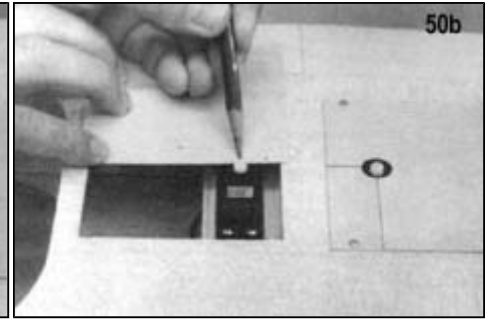
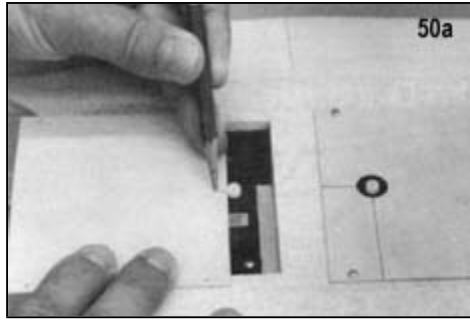

51. Place the hatch cover over the opening with the servo output shaft centered in the previously drilled 3/8" hole. Using the plywood servo hatch as a guide, drill four 1/16" holes through the balsa sheeting and the spruce hatch reinforcements in each corner of the hatch cover. Securely mount the hatch cover with four No.2 x3/8" sheet metal screws

52. Install the servo arms on the servo and check for proper clearance.

53. Temporarily install the aileron servos. Use a 1/16" drill bit and a pin vise to drill holes in the Lite-Ply servo mount for the servo mounting screws.

**MODELERS NOTE:**

There are many manufacturers of servos in the market place today and it seems like they all make their servos just a little bit different from one another. Depending on the make and type of servo that you use, the modeler may have to adjust the height of his servo by placing the plywood shims under the servos. The servo output arm must clear the plywood hatch cover by at least 1/32" to keep it from binding. This is also a good time to temporarily install an external charge jack and switch harness in the left servo hatch as shown in the photo

54. Glue in place the 1/4"x2"x2" balsa sheet that is shown in the photo. Make sure the mount is flush with the wing spar and against the sub-rib SR-1. When cured, apply a thin coat of thick CA to the top of the balsa sheet and allow to cure. Later the throttle servo will be taped to this.

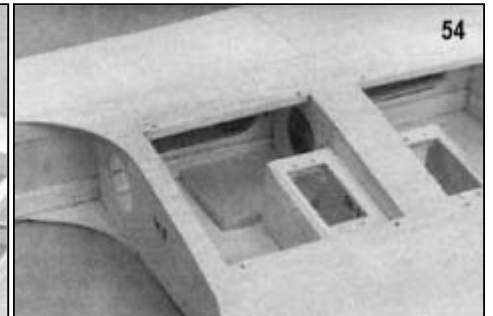
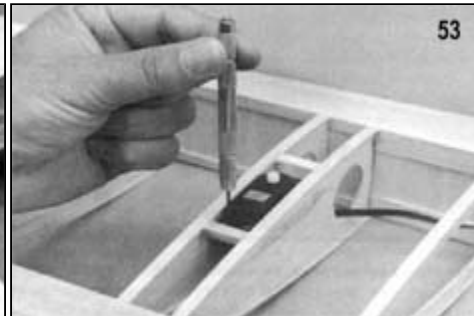
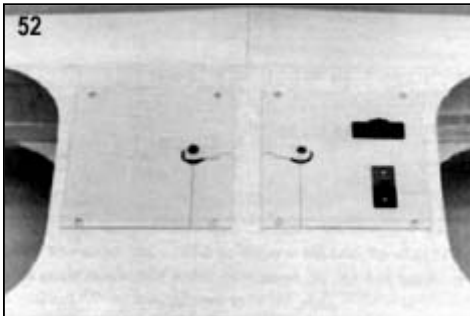

55. The exact location where the outer nylon pushrod tubing exits the leading edge sheeting is determined by the particular engine the modeler chooses (2-stroke or 4-stroke). It is recommended that you make a 1/8"x1/4" slot in the sheeting in the location shown on the plan. Temporarily install the outer nylon pushrod tubing for the throttle servo as shown on the plans. **Do not glue the tubing in place at this time.**

NOTE: Remove the servo hatches and all the servos from the wing at this time. They will be reinstalled later during the Final Assembly.

56. Give the wing a final sanding over it's entire surface with a long sanding block. Sand just enough to remove prominent high spots or bumps. Be careful! Excessive sanding may distort the airfoil shape.

## FIN AND RUDDER

57. Trim to fit and pin all pieces of 1/4" sq. balsa for the fin and rudder in place over the plan. Make sure you leave a 1/32" gap between the fin and rudder posts. Securely glue with thin CA glue.

58. Cut a piece of 1/4"x3/8" balsa to length and glue in place as pictured with thin CA glue.

59. Two special cut 1/4"x1"x4" balsa sheets have been provided for making the rudder counter balance (top) and the rudder bottom. Referring to the plan, carefully trim to fit and glue in place the counter balance and rudder bottom.



60. Round all of the outside edges of the fin and rudder with a sanding block with the exception of the top of the counter balance (top of rudder). Refer to step No.65 of the aileron construction and bevel the leading edge of the rudder so it can hinge properly.

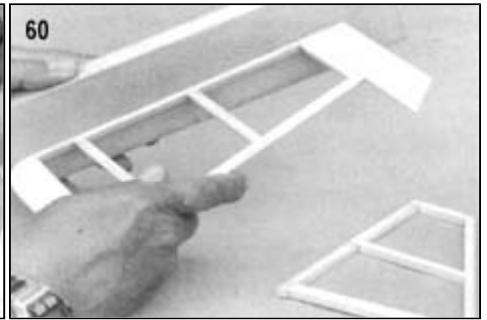
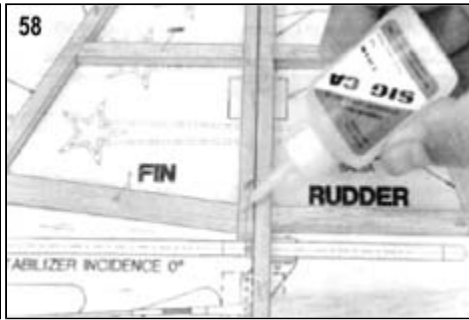

61. Using a modeling knife, slot the bottom of the rudder and glue in place the pre-bent tailwheel wire with a thin CA glue as shown in the photo.

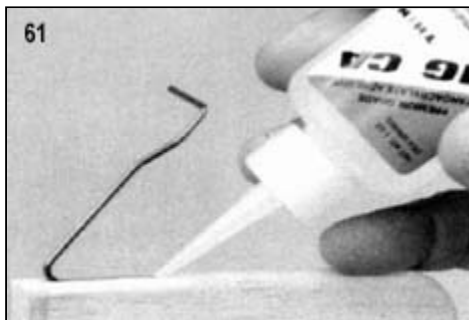

62. Reinforce the tailwheel wire with a piece of glass tape and thin CA glue.

#### BUILDERS TIP:

Lightly spray the glass tape with 3M 77 soray contact cement and place over the wire and rudder. Soak the glass tape with thin CA until the weave of the glass tape is filled. When dry sand off any irregularities.

## AILERONS

63. Cut to length and pin all pieces of 1/4"x3/8" balsa for the aileron in place over the plan. Use a thin CA to glue all joints together and allow to cure.

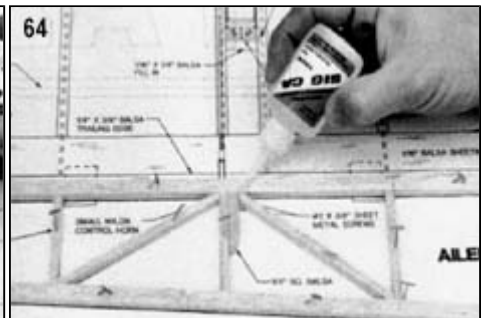

64. Cut to length and pin in place all 3/16"x1/4" balsa ribs and cross bracing. Make the 1/4" sq. balsa horn brace from scrap balsa and glue together using thin CA glue. Remove the aileron from the building board and sand both sides smooth with a sanding block.

65. Using a soft lead pencil, draw a center line down the leading edge of the aileron. Next, draw a line 1/8" back from the leading edge on the top and bottom of the aileron. Use a single edge razor blade or a small block plane to roughly trim the balsa down to the lines making a 45 degree angle on each side of the center line.

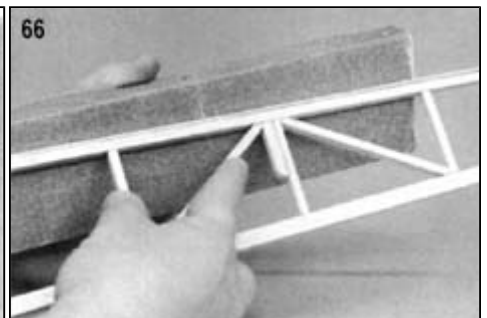
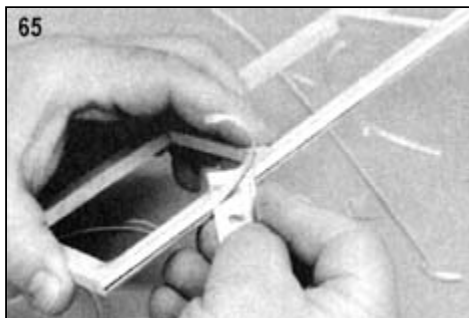

66. Finish sanding the aileron with a long sanding block to remove any high spots or bumps on the 45 degree angles. Round off the trailing edge of the aileron while leaving the wing tip and root ends of the aileron flat to match the wing tip and fuselage.

67. Repeat step No.63 through No.66 to build the opposite aileron.

## STABILIZER AND ELEVATOR

68. Cut to length the 1/4"x3/8" balsa that outlines the stabilizer and elevator and pin in place over the plans. Make sure you leave a 1/32" gap between the trailing edge of the stabilizer and the leading edge of the elevators. Glue it in place with thin CA glue.

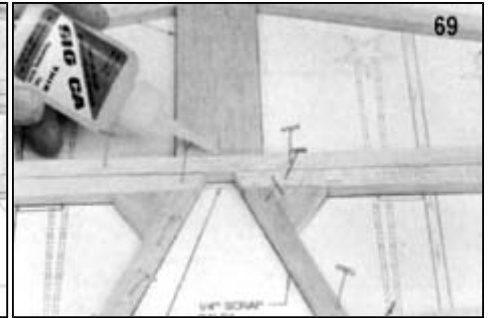
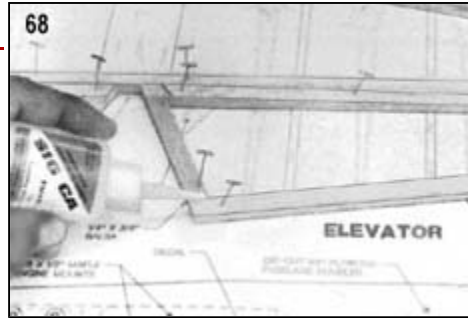

69. A special cut 1/4"x1 1/2"x4" balsa sheet has been provided for the stabilizer center section. Trim the piece to fit and glue in place over the plans. Cut the elevator gussets from a piece of 1/4"x2"x2" balsa sheet (note the grain direction as shown in the photo) and securely glue the gussets in place with thin CA glue.



**BUILDERS TIP:**  
Roughly cut the balsa pieces slightly oversize with a razor saw.

Then use a small sanding block, and sand then ends of the balsa pieces (a little at a time) until you achieve a perfect fit between the balsa parts.

70. Use a single edge razor blade and carefully trim to fit and glue in place over the plan the 3/16"x1/4" balsa ribs in the stabilizer and elevators. Remove the stabilizer and elevators from the building board.

71. Using a long sanding block, sand both sides of the stabilizer and elevators to remove any high spots or bumps. NOTE: Any imperfections that are not removed, will show through any covering.

- 72.
- Round the leading edge of the stabilizer with a long sanding block.
  - Using the same long sanding block, round the trailing edges of the elevators. NOTE: Do not round the ends of the stabilizer and elevators.

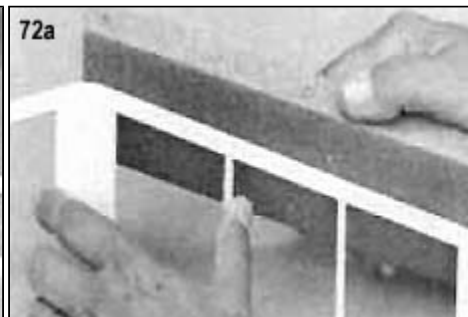
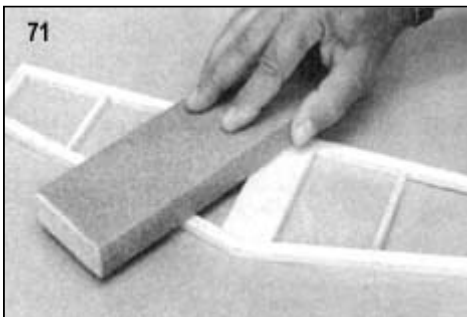

73. Draw a line down the center of the leading edge of each elevator. Measure back from the front of the leading edges 1/8" and draw a line on the top and bottom of the elevator leading edges. Use a single edge razor blade or a block plane to roughly trim the balsa down to the lines making a 45 deg. angle on each side of the leading edge. Use a long sanding block to finish shaping the 45 deg. angles.

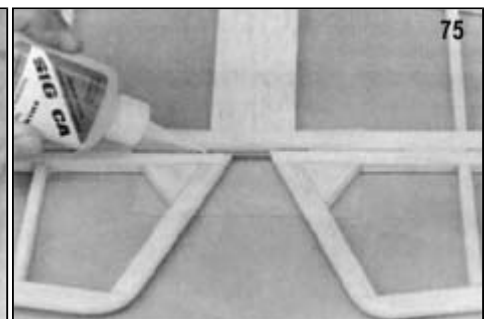
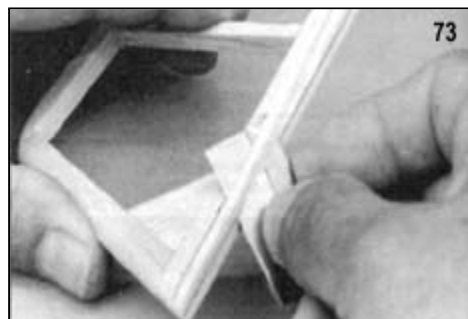

74. Place the elevators over the plan and mark the exact location of the pre-bent 3/32" music wire elevator joiner. Use a 1/8" drill bit and pin vise to drill a hole in the leading edge of each elevator deep enough for the short leg of the music wire joiner. Slot the leading edge of the elevators so the music wire joiner fits flush.

75. Thoroughly clean (thinner, alcohol) and rough up the short legs of the joiner with sandpaper. Tape the elevators (and music wire joiner) to the back of the stabilizer. Slip a piece of wax paper between the stabilizer and wing joiner and glue the wing joiner to the two elevators with thin CA. Allow the glue to cure. Remove the elevators from the stabilizer and apply a second coat of glue to the music wire joiner.

## FUSELAGE CONSTRUCTION

### A NOTE BEFORE BEGINNING:

The Fazer can be flown with either a 2 or 4-stroke engine. Whichever you choose, it is strictly a matter of personal preference. However, the 4-stroke engine is generally heavier than the 2-stroke engine. If the 4-stroke engine is selected, the engine mounts, plywood doublers, and the balsa fuselage must be shortened by 1 1/2". Moving the 4-stroke engine closer to the leading edge helps eliminate a lot of tail weight that would be required to properly balance the model. Patterns for shortening the plywood doublers have been provided later in these instructions.

76. The spacing of the maple engine mounts must be adjusted to fit your particular engine. Measure the distance between the engine mounting lugs of your engine to determine the correct spacing of the maple mounts. Install the maple mounts into the balsa fuselage and adjust the mount spacing by varying the thickness of the scrap balsa spacer under the bottom mount as shown in the photo.

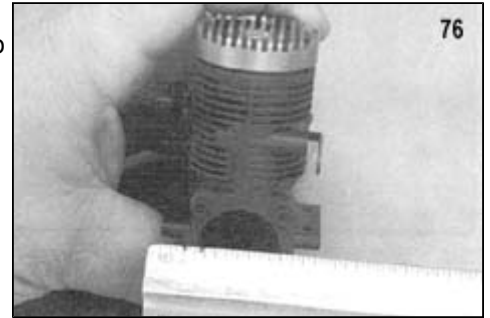

77. Because the fuselage is routed to shape (not band sawed) the engine mount slots have a slight radius to them at the rear. Slightly round the ends of the maple engine mounts for a flush fit. Glue the maple engine mounts in place along with the proper balsa spacer with thin CA glue.

78. Glue the 1/2"x4" balsa fuselage fill-in to the front of the fuselage and maple engine mounts as pictured in the photo.

79. Taper the ends of the left and right fuselage doublers with a razor plane or sanding block. Make sure you taper the outside ends of the doublers. **Not the insides**

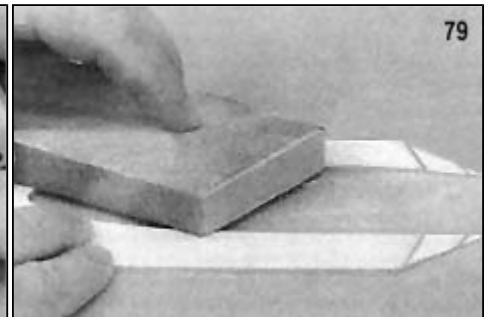
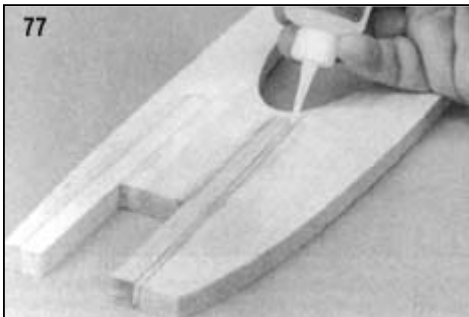

- 80.
- Glue the 1/8" plywood doublers to the balsa fuselage using a liberal amount of Sig Kwik Set Epoxy (5 minute) applied to the insides of the doublers.
  - Hold the plywood doubler in place until the epoxy glue has cured, with either metal weights or a stack of old books.

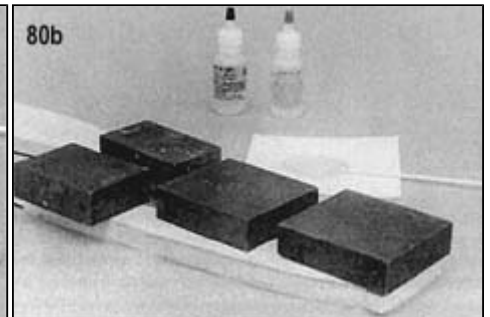
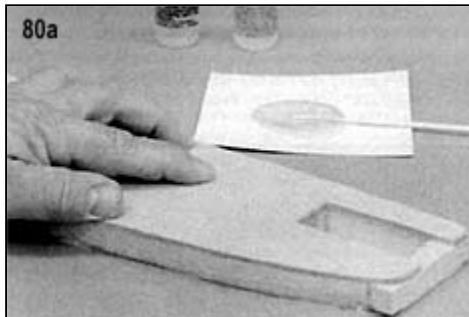

81. Use a small block plane to roughly round the edges of the plywood doublers and the balsa fuselage. Finish shaping the fuselage and doublers with sanding block equipped with 80 grit sandpaper.

82. Wrap a piece of 80 grit sandpaper around a piece of 3/4" dowel and sand a half round shape in the 1/2" sq. balsa fuselage fill-in (between the maple engine mounts) to provide enough clearance for the front of your engine.

83. The injection molded engine mount was designed to accommodate the smaller engines (.25 to .28 size). Depending upon which size engine you use, it may be necessary to trim the insides of the mount to fit your particular engine. Scribe lines have been provided on the face of the mount. Carefully measure your engine (refer to step No.76) and trim each side of the mount along one of these scribe lines.





84. Place the engine and the injection molded engine mount in a vise and mark the mounting hole locations with a center punch or a sharpened piece of music wire. Drill four holes through the molded mount at these locations with a 1/8" dia. drill bit.
85. Install the proper size propeller and spinner on the engine and place it and the moulded mount on the fuselage as shown in the photo. Make sure you have a 1/8" gap between the spinner and the front of the fuselage. Again, mark the mounting hole locations with a center punch or a sharpened piece of music wire.
86. Drill out the four engine mounting bolt holes and the three landing gear bolt holes with a 1/8" drill bit.

**BUILDERS TIP:**  
Apply thin CA glue to the inside of the previously drilled holes to strengthen the wood around each hole. Allow the glue to cure, then redrill the holes with the 1/8" drill bit.

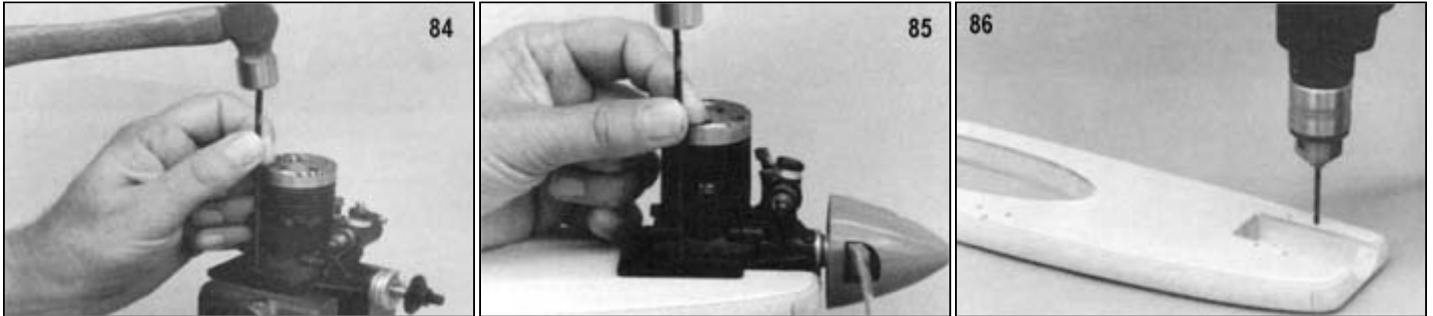

87. Drill the back side of each of the four engine mounting holes 3/16" deep with a 5/32" drill bit for blind nut clearance.  
NOTE: The 4-40 blind nuts will be permanently installed after the fuselage has been covered.

88. Slide the fuselage onto the wing until the fuselage is in the center of the wing. Verify this by carefully measuring from the wing tips to the sides of the fuselage with a tape measure or a long ruler.

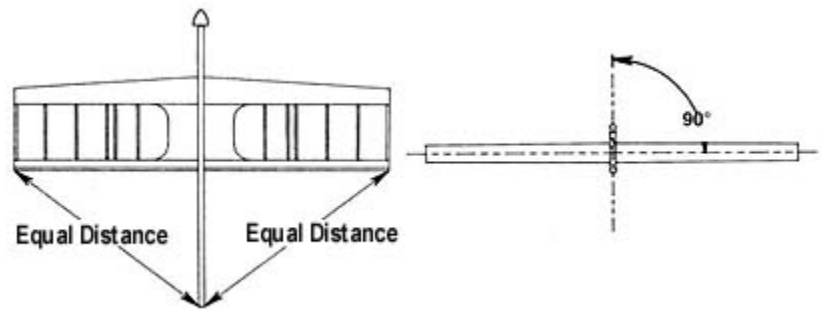

DO NOT GLUE AT THIS TIME.

Viewed from the top, check the alignment of the wing and fuselage by measuring from the trailing edge of each wing tip back to the end of the fuselage. Each of these measurements should be equal.

Also check the alignment of the wing and fuselage from the front. The fuselage must be perpendicular to the center line of the wing.

89. When satisfied with the alignment of the wing and fuselage, glue in place with thin CA glue. If necessary, fill any gaps between the fuselage and wing joint with Sig Kwik Set epoxy (5 minute).
90. Reinforce the wing and fuselage joint with glass tape and epoxy. A strip of glass tape 1"x12" has been provided, cut the glass tape into four equal pieces that are 3" long. Lightly spray the back of the pieces of glass tape with 3M 77 spray contact cement. Place the pieces of glass tape on the wing and fuselage joint overlapping them at the leading edge. Coat the glass tape with Sig Epoxy (slow drying) using an epoxy brush. Use only enough epoxy to fill (wet-out) the glass cloth. Remove any excess epoxy with a rag soaked in rubbing alcohol before the epoxy sets up.

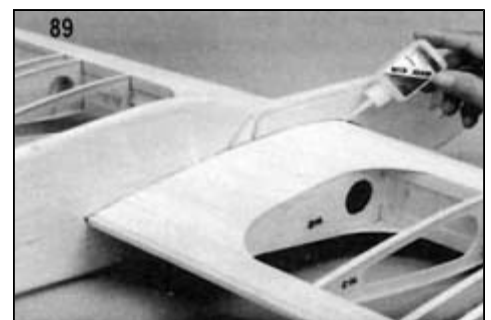

## COVERING YOUR FAZER

### A Note To The Modeler

The color scheme of the Fazer is not only attractive, it is a functional scheme as well. The roll rate of the Fazer is quite (very) fast and the flyer can easily become disorientated. If you choose not to use the color scheme that is shown on the kit box label, make sure the color scheme on the top and bottom of the model is different. This greatly helps the flyer maintain the proper orientation of the model during Maneuvers.

## Selecting A Covering

All of the FAZER prototypes were covered with Sig Supercoat Iron-on plastic covering. Supercoat covering is ideal for sport models because it's light weight and easy to apply. The color scheme that is pictured on the label is quite easy to duplicate and only requires three rolls of Sig Supercoat covering. The colors that are needed are two rolls of Waco Red and one roll of Dark Blue. You will also need one roll of Sig Supertrim White. The three large decal sheets that are provided have the remaining markings needed to complete the color scheme.

NOTE: If you choose another brand of covering material, be sure to read the manufacturers directions that come with the material. Follow their instructions when applying the material as different brand coverings have slightly different handling characteristics and application temperatures. However, the basic techniques for applying iron-on plastic coverings of any brand are pretty much the same. We also recommend that you use a temperature guage to set the temperature of your iron to the setting the covering manufacturer recommends (200 degrees F for Sig Supercoat Covering).

## Surface Preparation

A good covering job starts with good surface preparation. Remember, regardless of what kind of covering you choose, it won't hide poor workmanship. Fill any small dents or surface gaps with a lightweight filler or spackling paste. Sand the entire model including the ailerons and tail surfaces with 220 grit sandpaper, then again with 360 or 400 grit sandpaper.

91. The structure that is to be covered must be clean, dry and dust free. Wipe the entire model with a tack rag cloth dampened with alcohol to remove all excess balsa dust.

92. Cut four 12" strips of covering (Waco Red) that are 3/8" wide and fold in half along it's length. Iron one of these strips of covering to each of the four sides of the wing and fuselage joints. Attach the strip of covering to the side of the fuselage first with a hot sealing iron. For easiest application work from the trailing edge of the wing forward, stretching and sealing the strip to the fuselage. Keep the crease in the strip centered in the joint. By stretching the side of the strip that attaches to the fuselage, the other side of the strip will lay flat on the wing. Now seal the remainder of the strip of covering material to the balsa wing sheeting.

### BUILDERS TIP:

Before starting the actual applications of covering material, use a vaccum cleaner with a soft brush attachment and vaccum the entire model and work bench. This helps eliminate the dust particles that get under the covering.



### BUILDERS TIP:

Before applying any plastic film cover over itself it is a good idea to wipe the overlapped area with alcohol or thinner. This will remove any dirt or skin oil that would interfere with the film bond.

93. Cut or trace out a pattern of the fuselage profile from the plan. Use this pattern to cut-out a piece of covering (Waco Red) for each side of the fuselage (right and left). Allow approximately 1" of excess covering material around the outside edges of the fuselage and cut the wing opening approximately 1/16" oversize. Place the covering material on the fuselage side and smooth out as many wrinkles as possible. Iron the covering in place as shown in the picture overlapping the covering around all the outside edges of the fuselage. Repeat this step for the other side of the fuselage and overlap the seams of the covering material by at least 3/8".

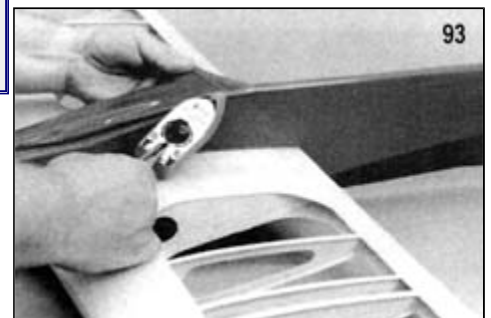

94. Cover the bottom of the wing panels with Dark Blue from the front of the wing spar to the back of the trailing edge as pictured. Cover the front of the wing panels with Waco Red. Make sure you overlap the Dark Blue with Waco Red covering at least 3/8".

95. Cover the top of both wing panels and the ends of the wing tips with Waco Red covering. Again make sure that you overlap the seams of the covering at the leading and trailing edges.



96. Cover the bottom sides of the stabilizer, elevators, ailerons, and servo hatches with Dark Blue covering.

97. Cover the top sides of the stabilizer, elevators, ailerons, and both sides of the rudder with Waco Red covering.

## Installing Easy Hinges

Sig's famous EASY HINGES have been included in your kit to hinge all the control surfaces. Each ultra-thin hinge is actually a three-part laminate, a tough plastic inner core sandwiched by an absorbant wicking material on each side. They are specially designed to be installed with thin C/A glue. The hinges have been chemically treated to slow down the set time of the glue to allow it to soak all the way to the ends of the hinge and into the wood surrounding it, for a super strong bond. Once the glue has dried, the hinge cannot be pulled from the structure without tearing wood out with it! We recommend that all surfaces be completely covered before installing the EASY HINGES.

98. Use a #11 X-Acto blade (or similar) to cut slots in the stabilizer trailing edge and elevator leading edge to accept the EASY HINGES. Make the slots approximately 1/2" in depth and slightly wider than the hinges. Refer to the full-size plan for the exact hinge locations.

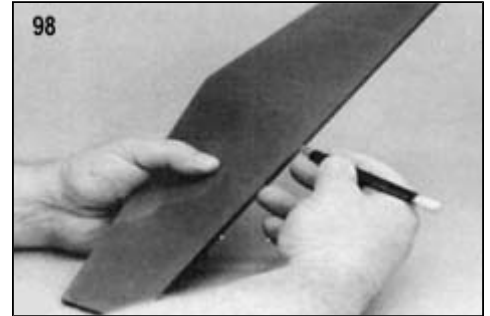

99. After all of the slots have been cut, insert EASY HINGES halfway into the stabilizer slots. DO NOT GLUE THE HINGES YET! Next, carefully slide the elevator onto the hinges. You'll find it easiest to slide the elevators onto the hinges at an angle, one at a time, instead of trying to push it straight onto all the hinges at once. Don't be concerned if the hinges aren't perfectly straight or centered in the slots - they don't have a center line.

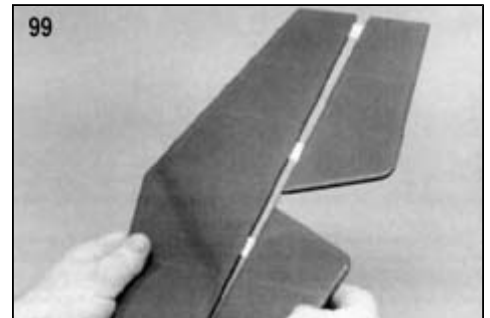

100. To set the hinge gap, deflect the elevator to the maximum amount needed. For best control response, the gap should be as small as possible but big enough to allow full movement of the control surface.

101. Place three or four drops of thin C/A directly onto the hinges in the gap. The glue will wick into the slot as it penetrates both the wood and the hinge. Continue this process, gluing the same side of all the EASY HINGES. Then turn the stabilizer over and repeat the gluing process on the other side of each hinge.

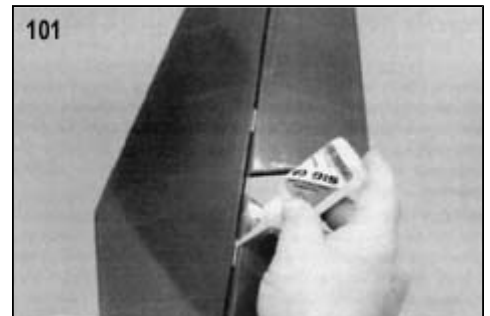

102. After the glue has cured (3 to 5 minutes) the joint should be flexed to full deflection in each direction a couple of dozen times to reduce the stiffness. Don't worry about shortening the life of the hinges, as they are almost indestructible.

103. The ailerons and the rudder are hinged exactly like the stabilizer and elevators.

## FINAL ASSEMBLY

104. Place the stabilizer in the slot at the rear of the fuselage. Refer to the top view alignment drawing and carefully align the stabilizer with the wing. When satisfied with the alignment, draw cut lines on the top and bottom of the stabilizer at the fuselage sides. Cut away the covering on the top and bottom of the stabilizer where it will be glued to the fuselage (there must be wood to wood contact in the glue joints). Use a sharp modeling knife or a single edge razor blade and don't cut into the balsa wood if possible.

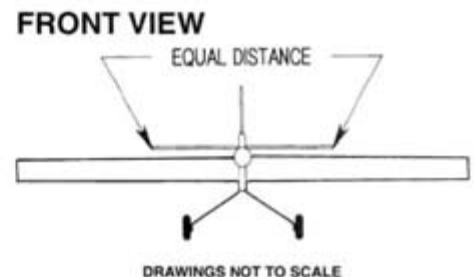
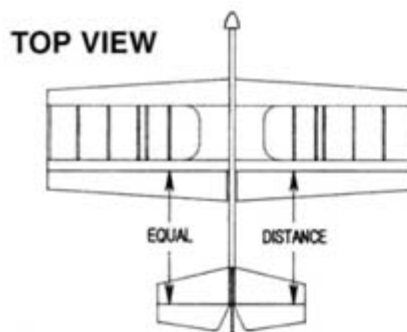



105. Glue the stabilizer in place onto the fuselage. Use slow drying epoxy to allow you ample time to carefully re-align the stabilizer with the fuselage and wing. Check and double check the final alignment of the stabilizer to the wing from the front and top before the glue dries. Step back about 10 feet and view the model from the front, as shown in the front view drawing. Tilt the stabilizer for proper alignment if necessary. Use a tape measure to make sure the stabilizer tips are at equal distances from the trailing edge of the wing. Use pins to hold the stabilizer in position until the epoxy glue cures.
106. Set the fin and rudder assembly in it's proper location on the back of the fuselage. Using a sharp modeling knife, trace around the fin lightly, cutting through the covering on the top of the fuselage. Remove the covering from under the fin so there will be a wood to wood contact between the fin and fuselage. Cut a hinge slot in the rudder and in the rear of the fuselage for the bottom rudder hinge. Epoxy glue the fin and rudder assembly in place on the fuselage. Also, insert the bottom rudder hinge into the fuselage when gluing the fin and rudder in place. Refer to the alignment drawing and make sure the fin and rudder are aligned perpendicular to the stabilizer. When satisfied with the alignment, pin in place and allow the glue to dry. Glue the bottom hinge into the rudder and fuselage with thin CA glue, as was done for all of the other hinges.
- 107 Round off the corners and smooth up the edges of the aluminum landing gear with a file or grinding wheel. Bolt the 2 1/2" main wheels (not provided) onto the aluminum landing gear with the 6-32 x 1 1/2" bolts, hex nuts and flat washers that have been provided. After the wheels are in place and the bolts are secure, trim off the excess 6-32 x 1 1/2" bolts flush with the 6-32 hex nuts. Use a drop of CA glue to keep the nuts from loosening up.
108. Install the aluminum landing gear onto the fuselage using the three 4-40 x 1 1/2" bolts and locking hex nuts. As in the previous step, cut off the excess 4-40 bolt flush with the nut.
109. Install a 3/4" tailwheel onto the tailwheel wire with a 1/16" wheel collar or by soldering it in place with small flat washers.

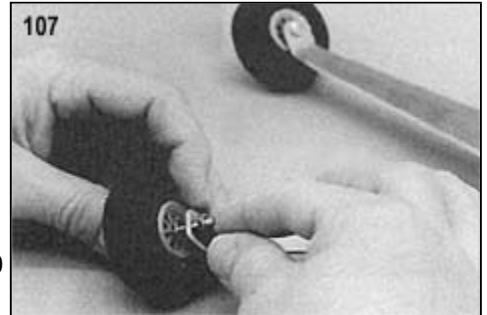

## TRIM AND DECALS

110. Refer to the plans, and cut out or trace a pattern of the white trim. Unroll and tape the White Supertrim to a flat surface. By slightly angling the pattern on the Supertrim there is enough material to cut out a left and right white trim pattern from one roll. Remove the paper backing from the trim and place on the wing.

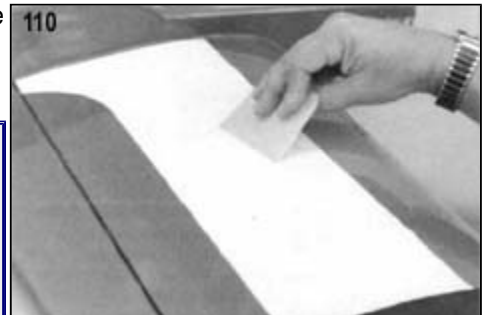

**BUILDERS TIP:** Find an empty window cleaner bottle and sprayer. Fill the bottle with water, add 4 or 5 drops of dishwashing detergent and shake up. Spray this solution onto the back of the decal (or trim) and onto the surface on which they will be placed. This procedure will allow you to position the decal in it's proper location without sticking to the covering. When satisfied with the location, squeegee out the water from under the decal with an epoxy spreader or a balsa paddle and allow to dry for at least 12 hours.

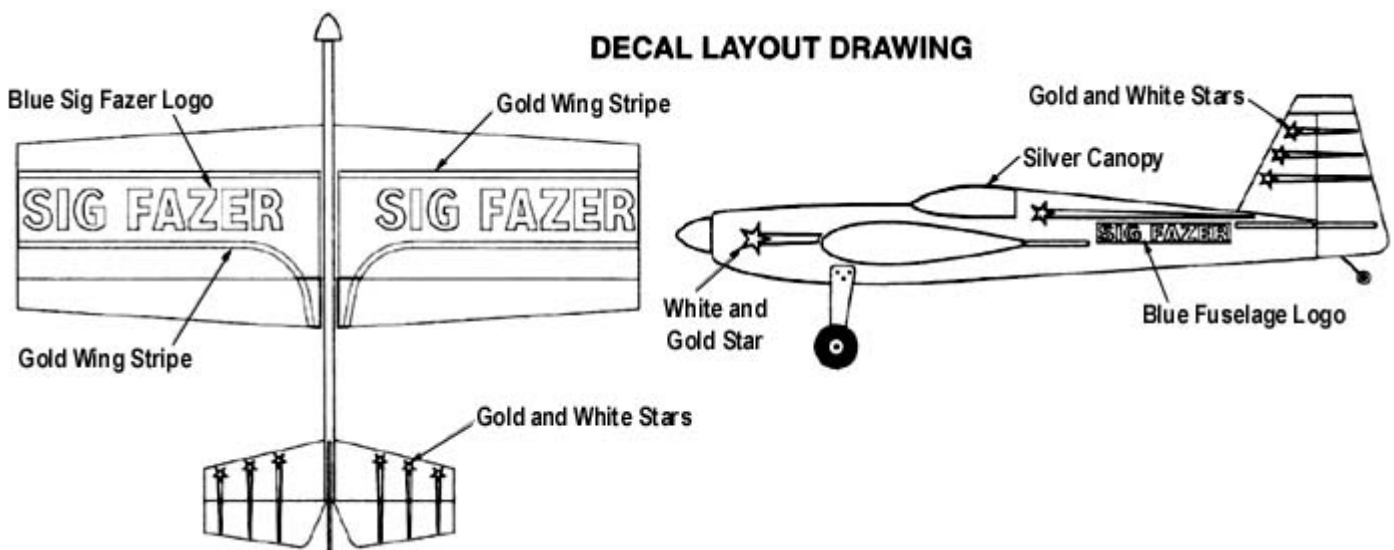

111. Cut out the decals using a modeling knife equipped with a sharp (new) No.11 X-Acto blade and a straight edge. Leave about 1/32" to 1/16" of clear mylar around the outside edges of the decal. Using the above procedure (Builders Tip), place the decals onto the model. Refer to the plan and the decal layout drawing to properly locate and position each of the decals.

NOTE: The star decals for the stabilizer and rudder are properly spaced on the decal sheet to match the locations on the plan. Cut out the stars from the sheet and use the sheet as a template to properly space these decals on the stabilizer and rudder.

## INSTALLING THE ENGINE AND TANK

---

112. In preparation for mounting the engine, install the four 4-40 blind nuts in the previously drilled holes. Lightly tap the blind nuts in place with a small hammer and glue in place with thin CA glue. Paint the blind nuts to match the color of the fuselage.
113. Securely mount the engine and molded mount onto the fuselage using the four 4-40 x 1 1/4" socket-head bolts that have been provided.
114. The fuel tank shown in the photo is a Sullivan 4oz slant tank. You will notice the overflow vent/pressure vent is located in the upper left hand corner of the tank. This is to allow the fuel tank to be completely filled when the model is sitting on its wheels. The pick up tube (clunk) must extend to the rear of the fuel tank and swing freely to all corners inside the fuel tank.

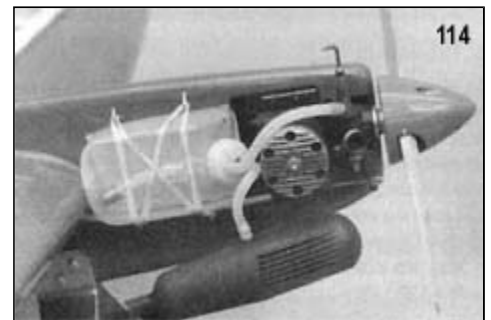

Place the fuel tank on the fuselage and mark the locations of the 4-40 J-Bolts. Keep them close to the sides of the tank. Drill a 1/16" hole in each of these four locations and thread the J-Bolts in place. Place a piece of foam rubber under the fuel tank and temporarily rubber band in place with two No.64 rubber bands.

NOTE: The 1/8" o.d. nylon pushrod tubing is held in place by the rubber bands that secure the fuel tank.

## RADIO INSTALLATION

---

The servo out put arms that are supplied with the servos (or radio system) are equipped with four arms. Trim off two of the short arms and one of the long arms as shown in the following photos.

115. A 12"x.065 dia. throttle pushrod cable has been provided. Solder a 2-56 solder link to one end of the cable. Tin the end of the cable before you attempt to solder the 2-56 solder link to the cable.
116. Reinstall the 1/8" o.d. dia. nylon throttle pushrod tube in place and glue it to the plywood joiner with CA glue. Do not glue the nylon tubing to the leading edge sheeting until after the fuel tank has been installed.  
NOTE: 1/8" o.d. nylon pushrod tubing must be trimmed off at the rear of the engine. Save this piece of tubing for the pushrod guides.
117. Slide the throttle cable pushrod into the nylon pushrod tubing. Next, temporarily install the throttle servo in place and connect the throttle cable to the out put arm with the 2-56 solder link.  
NOTE: The servo out put arm as pictured in the photo is in the low throttle position for the HP Goldcup .40 engine. On other makes of engines, this may be the high throttle position.
118. Make sure that the servo out put arm and the engine throttle lever are both in the high throttle position. Connect the throttle cable to the engine with the provided Sig E-Z connector and trim off any excess throttle cable.

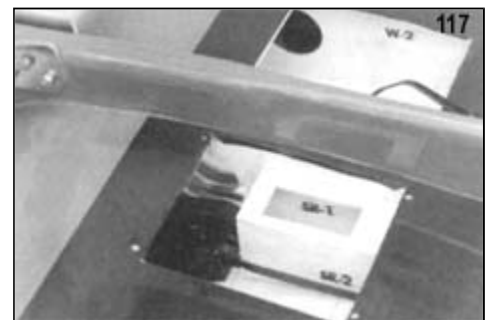

119. Remove the throttle cable from the model and stiffen the cable by soldering the last three inches of the cable as shown in the photo. Use plenty of heat and flux so the solder sweats into the cable. Carefully wipe off any excess solder on the cable while it is still hot. When cool, lightly sand the cable so it slides smoothly in the 1/8" o.d. nylon tubing.
120. Permanently install the throttle servo at this time with the provided 1/2" servo tape. This servo tape is super sticky, so make sure that you have the servo lined up properly before pressing the servo in place onto the 1/4" balsa servo mount.

121. Mount the two small nylon control horns onto the ailerons and the two medium control horns onto the elevator and rudder. Mount the "left handed" control horn on the right side of the rudder in the location shown in the photo. This minimizes the bend in the elevator pushrod. Drill the mounting holes with a 5/32" drill bit and a pin vise. Mount each nylon control horn with two No. 2 x 1/2" sheet metal screws that are provided. Do not crush the balsa control surfaces by over tightening the sheet metal screws.

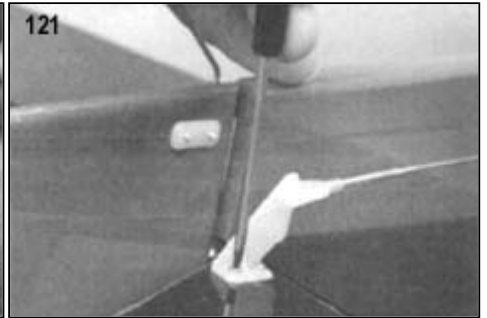
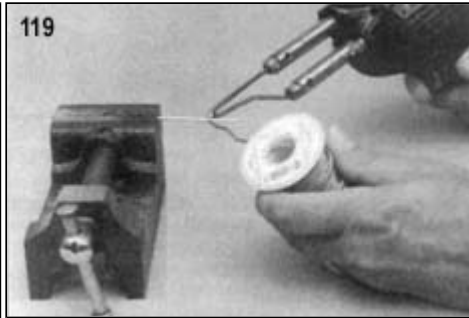
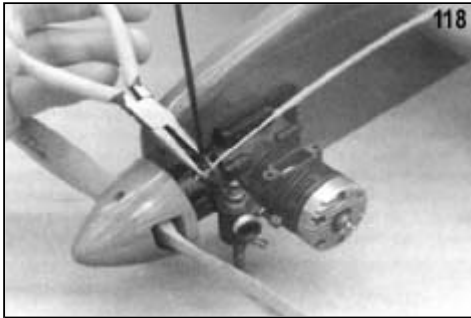

122. Reinstall the aileron servos with out put arms into the wing.

123. Make the aileron pushrod by threading one of the nylon RC links half way onto the end of a 2-56 threaded rod. Next, attach a 2-56 solder link to the servo out put arm and connect the nylon RC link to the aileron control horn. Using a pair of side cutters, cut off the excess threaded rod, leaving enough wire to allow a solid solder joint in the solder link. Remove the solder link and threaded rod and solder the link to the end of the threaded rod. Repeat this to make the other aileron pushrod.

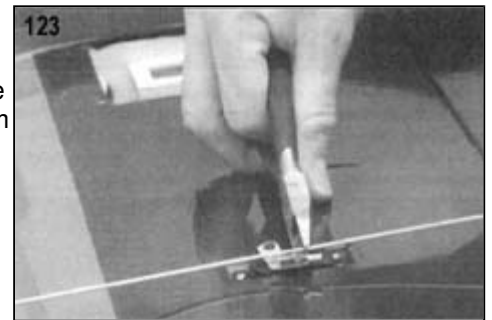

124. Reinstall the elevator and rudder servos and temporarily install the servo hatch covers and the servo out put arms.

125. Two 1/16" dia. x 24" music wire pushrods have been provided for the elevator and rudder. Make the elevator pushrod by soldering one of the 2-56 threaded brass couplers (provided) to one end of the music wire pushrod. Thread a nylon RC link half way onto the threaded brass coupler. As in the previous step, attach a 2-56 solder link to the servo out put arm and connect the RC link to the nylon elevator control horn. (Slip a piece of 1/8" o.d. x 1/2" nylon tubing over the 1/16" music wire pushrod. This nylon tubing will be part of the pushrod guide in the next step.) Using a pair of side cutters, cut off the excess music wire leaving enough wire to allow a solid solder joint in the solder link. Remove the solder link and the pushrod from the model and solder the link to the end of the 1/16" dia. music wire pushrod.

126. Attach the pushrod to the elevator control horn and to the servo out put arm. Securely screw the servo out put arm in place and make sure the out put arm and the solder link clear the hatch cover.

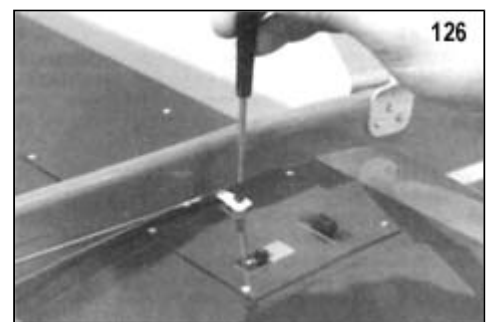

127. Repeat steps No.125 and No.126 to make the rudder pushrod.

128. Because of the many different sizes of servos that are available, the location of the pushrod guides may vary slightly on the side of the fuselage. Place one of the landing gear clips onto the nylon tube (that was previously installed on the pushrod) and hold the pushrod and the landing gear clip to the side of the fuselage 6 1/4" from the trailing edge of the wing. Viewing the pushrod from the side, move the landing gear clip up or down to align the pushrod. The pushrod must be straight from the out put arm to the nylon control horn. Mark the location and drill two holes through the side of the fuselage with a 1/16" drill bit.



129. Make two spacers from scrap Lite-Ply and paint or cover them to match the fuselage. Use the nylon landing gear clip as a guide and drill two 1/16" holes in the Lite-Ply spacers. Assemble the pushrod guides by clamping the 1/8" o.d. nylon tubes in place with the nylon landing gear clips and by inserting the two 2-56 x 1" bolts through the fuselage, Lite-Ply spacers, and landing gear clips. Tighten the hex nuts with a pair of long nose pliers and place a drop of thin CA glue on each of the hex nuts to securely lock them in place.

130. Install the radio receiver and the battery pack in the left wing hatch. Wrap the receiver and the battery pack in a layer of foam rubber.

NOTE: To help balance the model, the battery pack can be positioned in the front or the rear of the servo hatch compartment. Remove all the kinks and bends out of your antenna and run it out through the nylon tube in the left wing.

## RADIO SET UP

The transmitter and the receiver batteries must be fully charged before you can properly set the control surfaces to neutral and adjust the control throws.

131. Cut out and glue to a stiff piece of cardboard the aileron positioning guide. Use this guide to check the neutral position of each aileron. Place the guide on the bottom of the wing at the W-3 wing rib. Adjust each of the ailerons to its neutral position by screwing the nylon RC link in or out until the aileron sits flush on the guide.

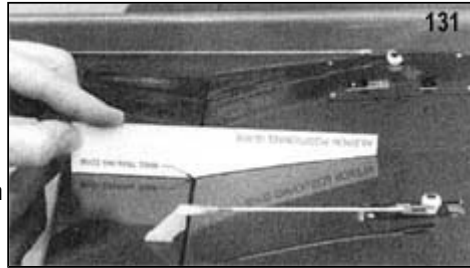

132. The elevator and rudder must also be in the neutral position. Again, screw the nylon RC links in and out to adjust these control surfaces.

133. Place the model on a flat surface and measure the amount of elevator travel with a ruler as pictured in the photo. Adjust the elevator travel to the dimensions that are listed in the chart.



134. Again, check and adjust the aileron travel as per the dimensions in the control travel chart.

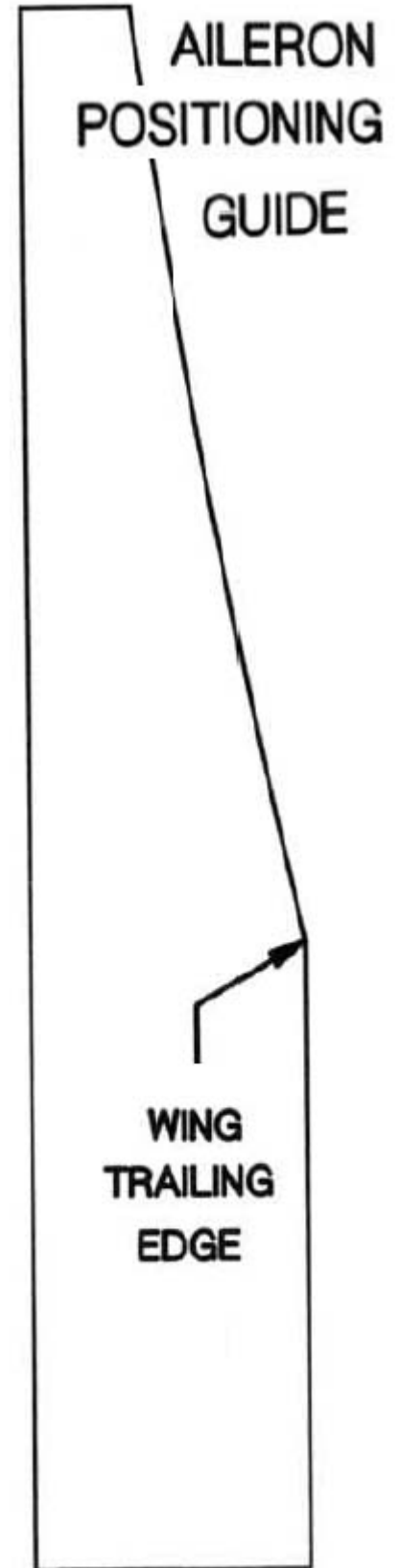
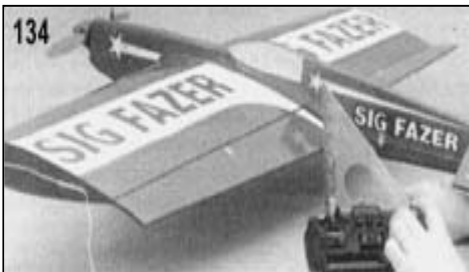

Because there are so many manufacturers of radio equipment, it would be almost impossible to tell the modeler how to set up each type of radio for their Fazer. Listed below is a chart that gives the modeler the suggested control travel for each of the control surfaces of the Fazer. The second chart deals with the radios that have mixing capabilities. Listed are the types of mixing that is desirable and the effects they have on the flight performance of the Fazer.



NOTE: The control throws listed are a good starting place. When the modeler feels more confident with the Fazer, the control throws can be increased ( a little at a time) to a maximum of 45 degrees for the elevators and ailerons

Control Travel Chart		
Item	Low Rate Travel	High Rate Travel
ELEVATOR	3/4" up 3/4" down	1 1/2" up 1 1/2" down
AILERONS	1" up 1" down	2" up 2" down
RUDDER	1 1/4" left 1 1/4" right	1 7/8" left 1 7/8" right
THROTTLE	Full range of throttle lever on carb.	

Control Mixing Chart		
Mixing	Control Surfaces	Effect
FLAPERON	Elevators and Ailerons	Flaperon mixing is a desired feature because it allows the ailerons to continue to work while the flaps are deployed (or mixed). EXAMPLE: When the flaps are in the down position and you make a right turn, the right aileron raises up allowing the model to turn in that direction.
ELEVATOR FLAP	Elevators and Flaps	Elevator to Flap mixing is also a desired feature. It allows the flaps and elevators to work together but in the opposite directions of each other. (When mixed together, the flaps travel downward and elevators travel upward and vice versa). This gives the Fazer the ability to make super sharp turns and loops.
3-POSITION SWITCH	Flaps and Elevators	Depending on your brand and type of radio, the three position switch located on the transmitter may be used to set the flaps in three different positions. Switch setting #1: Kick the flaps up to approximately 10 degrees. The flaps now act like the spoilers of a sailplane killing part of the lift of the wing. This allows the Fazer to make a faster descent for those quick take-offs and landings that fun fly models are known for. Switch setting #2: With the switch in this position, the flaps are held in the neutral position with the exception of the elevator to flap mixing for normal flying. Switch setting #3: Lower the flaps to about 30 degrees. This allows the Fazer to make very slow landings or to fly forward at a speed that is almost a hover.

## BALANCE YOUR FAZER

IMPORTANT: For optimum flight performance, balance your Fazer precisely where indicated on the full-size plan. We do, however, recommend that your Fazer be slightly nose heavy for the first few flights. When you become more familiar with the flight characteristics of the model, then move the balance point to the optimum location.

Make a balancer from a block of wood and two pencils that are tipped with erasers. Drill two holes in the block of wood about 3" apart and install the pencils with the erasers at the top.

Mark the balance point on the bottom of the wing by placing a piece of tape on each side of the fuselage 7" from the trailing edge of the wing. Place the model in the balancer with the ends of the erasers on these pieces of tape. If necessary, shift the battery pack or add weight to properly balance the model. Trying to fly with the balance point too far forward or too far aft is much more dangerous than the slight increase in the wing loading caused by adding nose or tail weight.

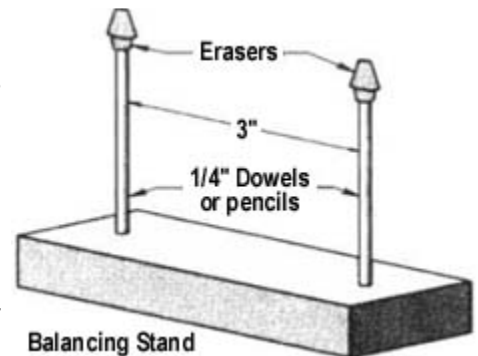

Always balance the model with an empty fuel tank so that it sits level on the stand.

In addition to the fore and aft balance, it's more important that you balance the Fazer spanwise. A heavy wing on one side can result in poor loop tracking. To check this, hold the model upside down by the front of the spinner and the tailwheel. The heavy wing should fall towards the floor. Add small amounts of weight to the opposite wing until the model is balanced.

## PRE-FLIGHT CHECKOUT

---

Make sure your servos are securely mounted and that the servo arms have their retaining screws in place. It is also a good idea to re-check all the pushrod connectors, fuel tank mounting, fuel lines, wheels, engine mounting bolts and tighten the prop and spinner. Range check the radio as per the manufacturer's instructions and make sure it is fully charged. If there are any problems, send the radio in for repair.

**Double Check Everything You Can Think Of!** A model and radio that are not prepared and working properly on the ground before take-off will not improve in the air - IT WILL GET WORSE! - There is no point in attempting to fly until everything is 100% correct.

## FLYING

---

The Fazer was designed for R/C pilots who can keep up with highly aerobatic models. Lower time pilots are encouraged to seek out the help of a more experienced pilot during the first few test flights.

Keep the control throws on the low rate settings and stay at least three mistakes high. Once you get the feel for the model try a few simple maneuvers like rolls, loops, stall turns and knife edge flight. Then as the "SIG Factory Flyers" call it, "take the skirt off" and turn on the high rates - be ready for some really wild maneuvers that are so quick you won't believe it.

Caution, until you are familiar with the response time and the shape of the Fazer leave yourself plenty of room for recovery. Recovery is never much of a problem, it can be done as fast as you get into trouble but you do need to leave room and time until you've got it together. One other warning, it is very easy to get in the habit of flying very close in- the deception of "slow speed" and fast response time combined with a minor mistake during recovery can get the Fazer behind you faster than you can read this sentence. You can endanger yourself, other flyers and any spectators very easily. Get a little practice and you won't believe how much fun you'll have while still flying safely.



### Warning - Danger - Important! Read These Warnings:

- A model airplane motor gets very hot and can cause serious burns. Do not touch the motor during or after operation.
- Keep clear of the propeller, it can cut off a finger or put out an eye. Make sure the propeller is securely fastened in place and is not cracked.
- Model engine fuel is flammable and poisonous. Take the same precautions while transporting and using it that you would with a can of gasoline or a bottle of poison.
- Remember that it is possible to lose control of a model airplane. Do not fly in locations where the model may hit people or damage property if loss of control occurs. Check your model equipment regularly to insure it is in safe operating condition.

## 4-STROKE CONVERSION

Because the 4-stroke engines almost always weigh more than 2-stroke it is necessary to shorten the nose of the Fazer by 1 1/2". Also, some of the large frame .40 2-strokes weigh as much. Choose your engine carefully to keep the overall weight down.

135. Remove the patterns from these instructions and place them on the 1/8" plywood fuselage doublers. Use a soft lead pencil and trace around the outside of each of the patterns. Cut out the fuselage doublers with a jigsaw.

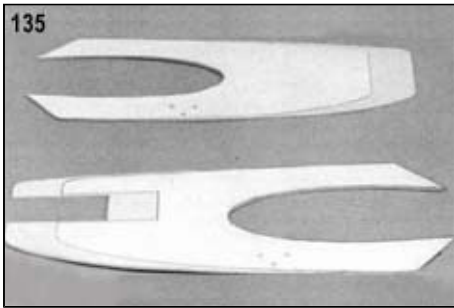

136. Place the left fuselage pattern (the one without the engine cut out) onto the balsa fuselage. Again trace around the pattern and cut out the fuselage with a jigsaw. After the fuselage is cut down to the size of the left doubler, remove an additional 1/2" from the front of the fuselage for the 1/2" sq. balsa fill-in.

137. Trim 1 1/2" off each of the 3/8"x1/2"x5 3/4" maple engine mounts and glue the maple mounts and balsa spacer into the balsa fuselage (refer to step No.76 of the fuselage construction). Also glue the 1/2" sq. balsa fill-in to the front of the fuselage as shown in the photo.

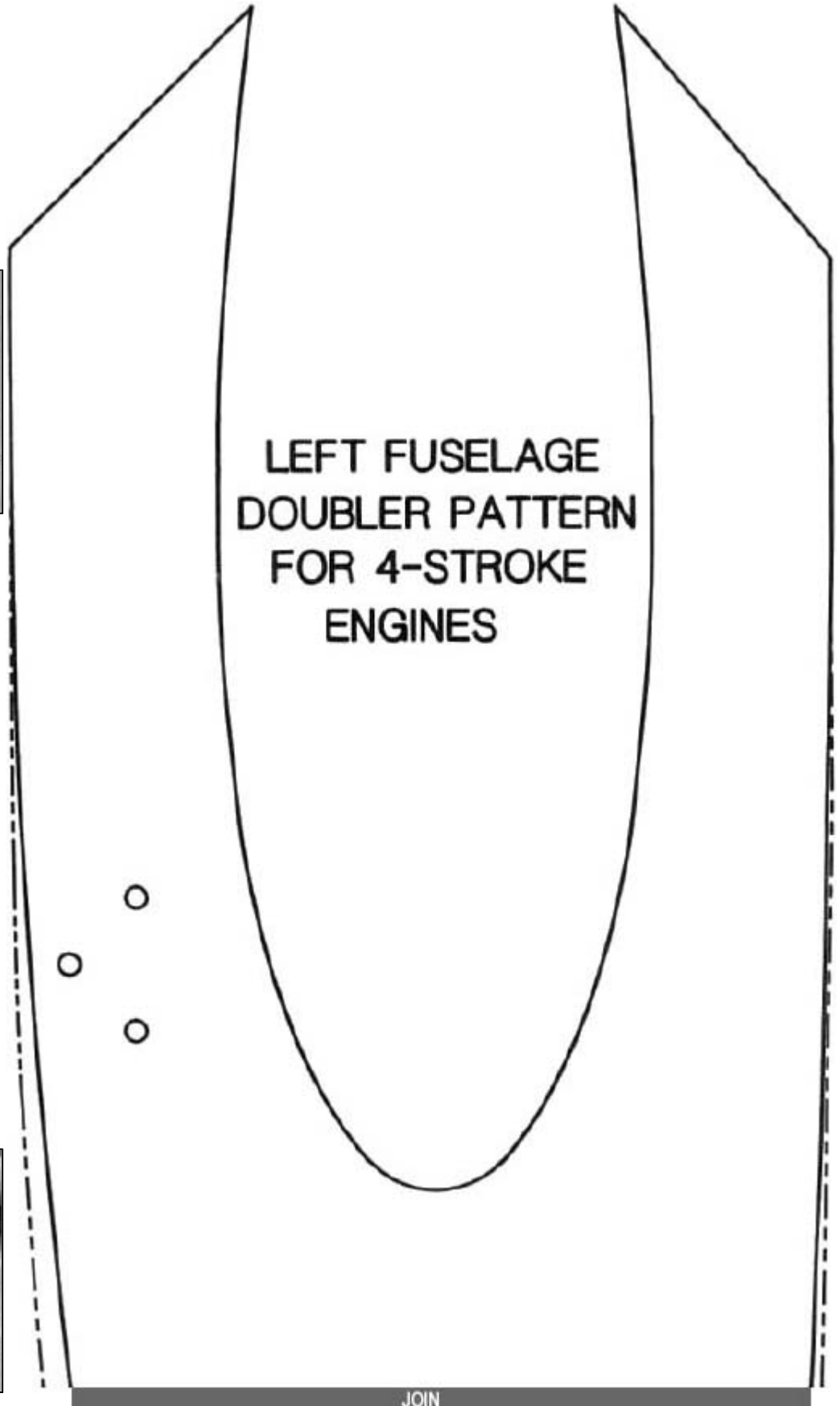
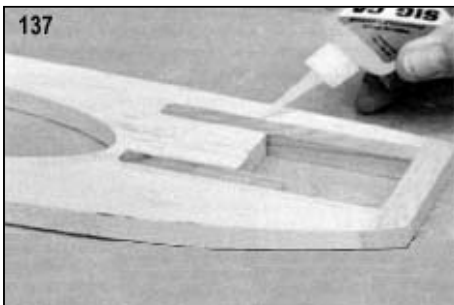

JOIN

LEFT FUSELAGE  
DOUBLER PATTERN  
FOR 4-STROKE  
ENGINES

RIGHT  
FUSELAGE  
DOUBLER  
PATTERN

FOR  
4-STROKE  
ENGINES

JOIN



138. Refer to steps No.83 through No.87 and install the 4-stroke engine on the fuselage.

NOTE: The carburetor on this 4-stroke engine (Saito .50) had to be reversed so the high speed needle valve was accessible from the top of the model. This makes it much easier to adjust the carburetor while the engine is running. Also the throttle cable and nylon tubing line up with the throttle lever on the carburetor.

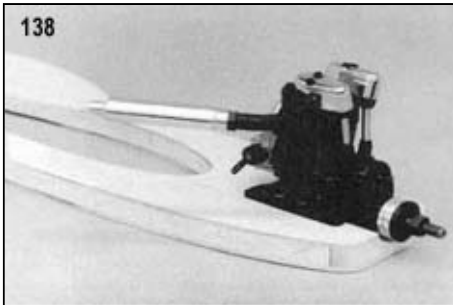

139. The 4-stroke engine installation requires the fuel tank to be mounted on the opposite side of the fuselage as shown in the photo. Refer to step No.114 and mount the fuel tank as described in that construction step. After the model is complete, hook up the fuel line to the carburetor inlet and run the fuel line across the top of the fuselage to the pick up tube in the tank.

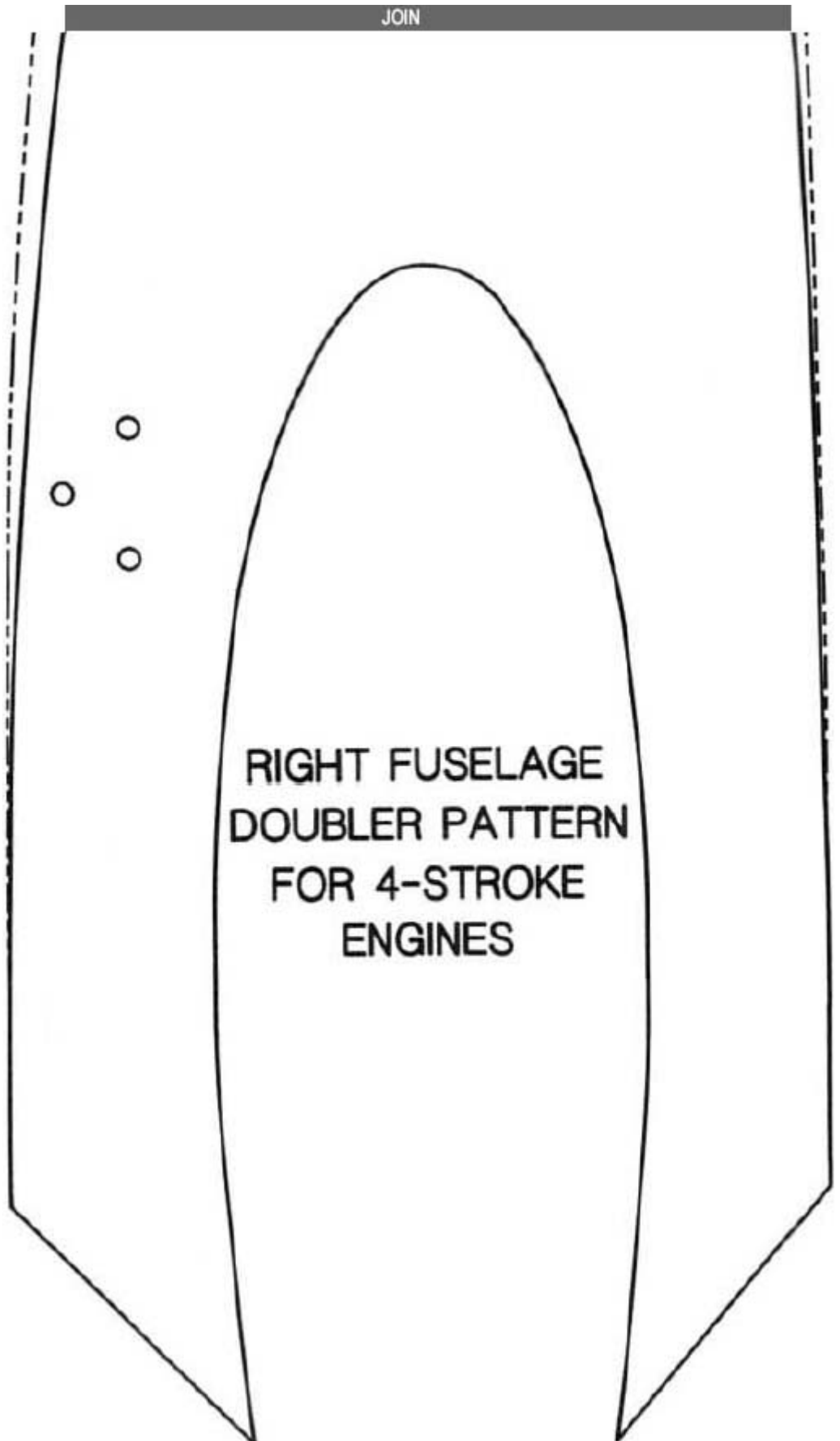

## CONTROL LINE CONVERSION

Sig Mfg. receives many requests from modelers for instructions and drawings to help them convert R/C models into control-line models. Because the heritage of the Fazer is partly based on control-line type models, it is quite easy to modify the Fazer for control-line. Follow these instructions to convert your Fazer into an exciting stunt model.

140. The wing is built basically the same as the R/C version as described in steps No.1 through No.56 of these instructions. Cut out the clearance holes in the wing ribs W-2 and W-4 for the lead out wires to pass through. Use the balsa lightening hole that was die-cut from the W-3 wing rib as a guide to cut-out the clearance hole in each of the ribs.

NOTE: Eliminate the W-4 wing ribs, the SR-2 sub ribs and the Lite-Ply servo mounts as they are not needed for the control-line version.

141. Attach the leadout cable to the bellcrank by bending over the cable at least 2" from the end. Be careful not to kink the cable wire. Pass the leadout cable through the outside hole in the bellcrank and wrap it tightly and neatly with the copper wire for at least 1/2". Fold the remaining cable back towards the bellcrank and continue wrapping the copper wire over the cable in the opposite direction. Cut off any excess copper wire and cable. Smear a thin coat of epoxy over the binding to keep it from unwinding. Repeat this step for the other leadout cable.

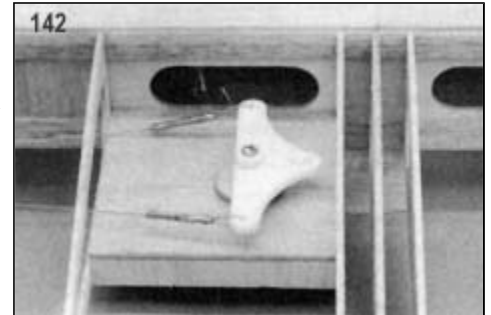

142. Make a bellcrank mount from 1/8" birch plywood that measures 2 1/2"x3 5/8". Epoxy glue the mount in place making sure that the plywood mount is resting on top of the bottom balsa spar and against the plywood wing joiner. Reinforce the bellcrank mount with a piece of 1/4"x3/8" balsa glued between the W-2 wing rib and the SR-1 sub rib. Make a bellcrank spacer from 1/8" plywood and mount the bellcrank and leadout cables as shown in the photo.

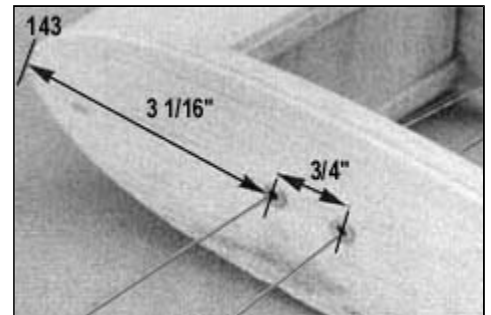

143. Using the dimensions that are in the photo, install two 1/8" o.d. eyelets in the outside of the wing tip (WT). Pass the leadout wires through the brass eyelets and tie the ends of the leadout cables as described in step No.141.

144. Make a bellcrank pushrod from 3/32" dia. music wire (This pushrod extends from the bellcrank to the top hole of the nylon flap horn). Install the pushrod into the inside hole of the bellcrank arm and solder it in place using two #3 flat washers.

145. Sheet the center section of the wing as described in steps No.26 and No.37. Cut an exit hole in the sheeting for the 1/32" pushrod to pass through.

146. Epoxy glue 1 1/2 oz. of lead weight in the outboard wing tip.

147. The flaps are built in the same manner as shown on the plan. Add an additional 3/16"x1/4" balsa cross bracing in each rib bay of the flap. When both flaps are completed, make a flap joiner wire from 3/32" music wire (copy the elevator joiner wire). Refer to step No.75 and join the two flaps together. Build the fuselage, stabilizer and elevators as shown in the instructions and on the plan.

148. Build the fin and rudder as shown on the plan and in the instructions, but do not hinge the two together. Permanently glue the fin to the rudder with the rudder offset to the outside of the circle 3/16".

NOTE: The model must be covered and the final assembly completed before hooking up the controls.

149. Mount a medium nylon control horn on the inboard flap. Make sure that the holes in the nylon control horn are centered in the middle of the hinge gap. Mount a medium nylon control horn on the bottom of the left elevator. Again make sure that the holes in the horn are centered in the hinge gap and then hook up the controls as shown in the drawing below. The controls must be smooth and free of any binding. If not, find out why and correct the problem before proceeding any further.

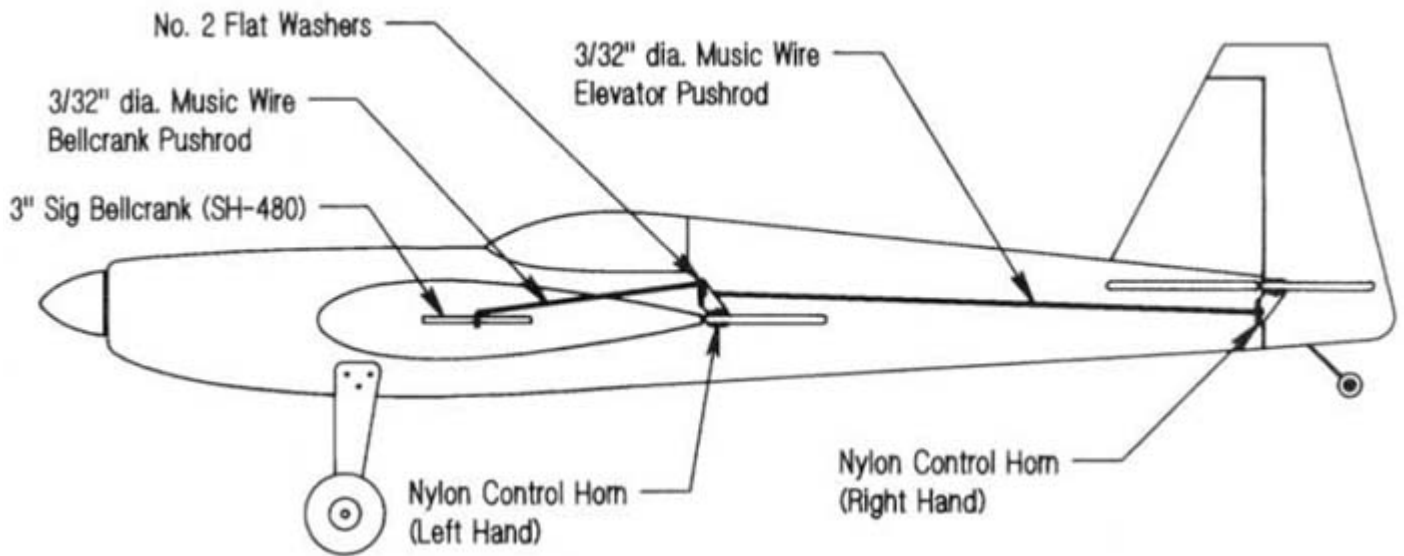

150. Our prototype control-line Fazer has flown with a OS .40 FP Stunt engine and a 11"x 4 APC Prop. This combination worked extremely well with more than enough power to fly the model through the entire AMA stunt pattern, even in windy conditions. The low pitched prop allows the engine to run at a higher R.P.M. keeping the engine in it's peak horse power range. Mount a 4 to 4 1/2 oz. metal fuel tank to the fuselage with J-bolts and two No.64 rubber bands. Make sure that the centerline of the fuel tank is lined up in the center of the engine venturi as shown in the photo.

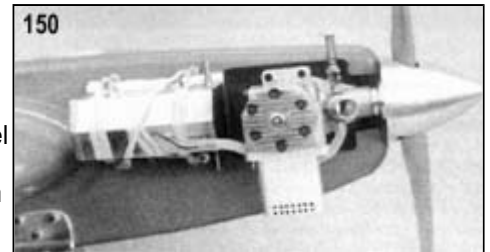

151. Balance the model in the location that is shown on the plan.

152. Fly the Fazer on .015 dia. x 65' lines measured from the center of the model to the handle. Use a good control-line handle that has adjustable line spacing and start out with the spacing set at 3 1/2" between the lines. If the controls of the model feel too sensitive, reduce the line spacing of the control handle. If too sluggish, increase the line spacing.

---

© Copyright SIG Mfg. Co., Inc.

**SIG MFG. CO., INC.....Montezuma, Iowa 50171-0520**

**LIMIT OF LIABILITY:**

In use of our products, Sig Mfg. Co.'s only obligation shall be to replace such quantity of the product proven to be defective. User shall determine the suitability of the product for his or her intended use and shall assume all risk and liability in connection therewith.