



KOUGAR

MARK II
SIGRC35



BUILDING AND FLYING INSTRUCTIONS

The Kougair was designed as an advanced aileron trainer for fliers who have had some flying time on an intermediate trainer such as the Sig Komander or Sig Kavalier. While it is very maneuverable and can do difficult FAI pattern maneuvers and even accomplish lomcevaks, the model has been carefully tailored to handle easily and not be touchy in the hands of novice fliers. A fully symmetrical wing section provides good inverted and outside stunting characteristics.

For use as a trainer, a .40 cu. in. engine is recommended. A .45 gives faster performance and would be good for pattern competition. One of the prototype models was powered by a .49 and the model is strong enough to handle this amount of power though this engine size is advisable only for advanced contest or sport fliers who wish to achieve high flying speed and steep angles of climb.

A Note About Balsa Wood

We do our best to put as good a grade of balsa in our kits as the supply situation permits. The world-wide increase in demand for balsa has made it impossible to obtain as high an average quality as used to be the case and this situation is getting worse.

Every piece of balsa supplied cannot be 100% perfect or kit prices would have to be greatly increased. Mineral stains or small knots do not seriously affect wood strength. Even with the very best grades of balsa, there is a natural tendency for some sticks or sheets to immediately bow upon being cut off from a perfectly square block because of built-in stresses. In most cases, these can be bowed back into alignment during building. True up the edges of bowed sheet by trimming, using a metal straight edge to cut against. Planking sheets, as used on the wing, need not be perfectly flat since they must be curved into place anyway during construction. The gluing of the plywood doublers and stringers to the fuselage sides while they are pinned to a flat surface should flatten out any warps in the side sheets.

Recommended Glues

The framework should be glued with Sig-Bond resin type glue. Areas subjected to unusual strain, exposed to fuel or oil, or including metal pieces, should be epoxied with Sig Epoxy Glue or Sig Kwik-Set 5 minute type epoxy. Some specific pieces have other recommendations. You will find these in the directions concerning the part.

About The Building Sequence

The quickest and most efficient way to complete a model is to work on several pieces at the same time. While the glue is drying on one section you can start on or proceed with another part. We occasionally get suggestions that our instruction books should be in exact step-by-step building sequence. But this would result in many sentences starting "While the glue is drying on the fuselage, move to the wing etc." and a lot of jumping back and forth between assemblies with no consistent pictorial progression.

Also, a preselected building sequence by our choice might not suit your workshop space and time allotments. Therefore, we feel the present system of covering main assemblies in a unit works out best for the majority of kit builders. So keep in mind that the numbering sequence used in these instructions were chosen as the best way of explaining the building of each major assembly and is not intended to be followed in exact one-two-three fashion. Start on the wing at No.1 and after performing a step or two, flip over to the next main heading of "FUSELAGE CONSTRUCTION" and do a step or two there, then over to "TAIL ASSEMBLY" and so forth. You will, of course, arrive at points where you can go no farther until another component is available. For example, you need a completed wing before the fuselage can be completed. The way to understand these relationships is to read the instructions completely and study the photos before beginning to work.

Any reference to right or left refers to right or left as if seated in the cockpit.

You Can't Get Along Without a Good Sanding Block

An indispensable tool for proper construction is a large sanding block sized to take a full sheet of sandpaper. Use several wood screws along one edge to hold the sheet in place. Use the block to bring all parts and sticks to final, exact fit. We recommend 80-grit garnet paper for use on the block during general construction. You can switch to 100-grit, followed by 220 silicone paper for final finish just before covering.

In addition to the large block, there are places where a smaller one is handy. Also, a sandpaper "file" can be made by gluing sandpaper to a flat spruce stick for working tight-places. We have an especially handy extra long sanding block made from a 40 inch piece of aluminum channel with sandpaper glued to it that is particularly useful for jobs like truing up the leading edge and trailing edge of the wing core.

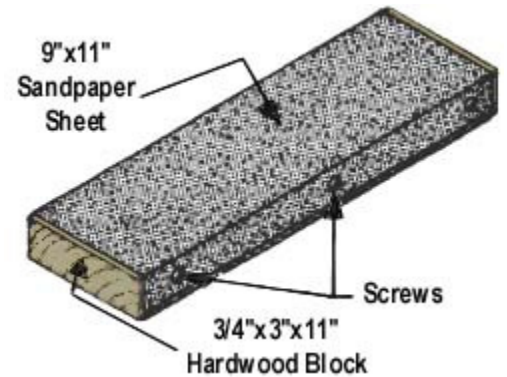

Cutting Out Printed Parts

A jig saw is best for this job. Cut just outside the lines, leaving all of the black line on the part. When fitting the part into place in the model, use the sanding block to bring the edges to an exact fit. If a modeling knife is used to cut out the parts, don't cut too close to the lines -- leave some extra wood outside the line. True up and finish the edge with the sanding block.

Some Rules To Follow

Cut all long pieces of balsa first, followed by medium lengths before cutting up any full-length strips into short pieces. Remove die-cut pieces from the sheets carefully. If difficulty is encountered, do not force the part from the sheet. Use a modeling knife to cut it free. Leave parts in the sheets until needed in construction.

A piece of Celotex-type wallboard makes a handy building board, into which pins can easily be pushed. Lay the building board on a table with a flat and untwisted top. Pins can be pushed through all pieces in the kit without any lasting damage. The holes will fill up during sanding and doping. Be careful where you use a ball point pen for making marks. If not sanded off, these marks will bleed through many coats of dope and show on the finished model.

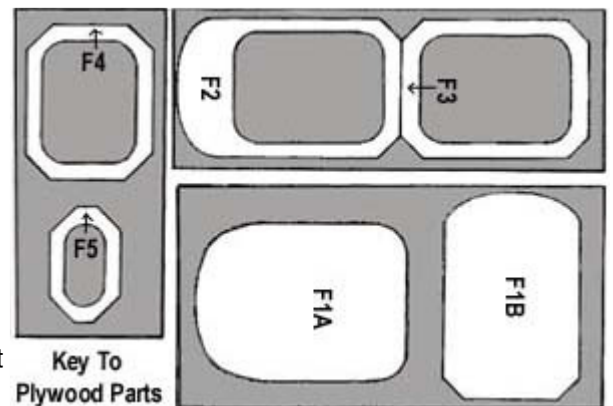

WING CONSTRUCTION

1. True up the edges of the fourteen 1/16"x3"x24" sheets of wing planking wood by trimming where necessary, using a metal straightedge as a guide. Use the large sanding block for final touch up of the edges.
2. Tape seven sheets tightly together with strips of masking tape.
3. Turn over and open up the joints, with the masking tape serving as a hinge. Put a bead of Sig Bond in each of the seams and close the joint.

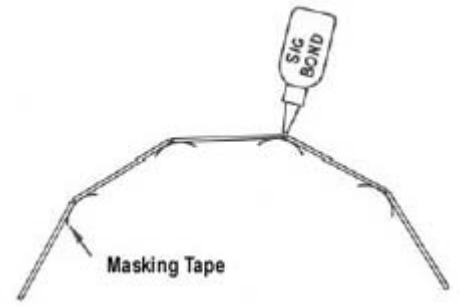
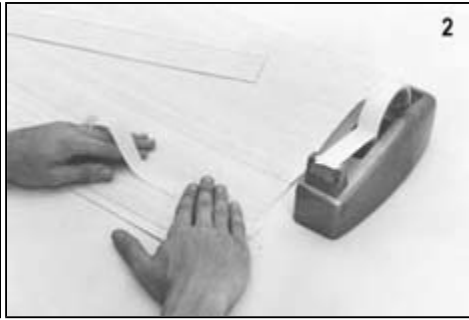
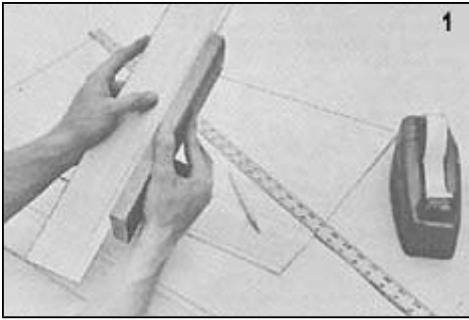

4. Lay the sheets flat. Scrape off the excess glue with a squeegee made from a balsa scrap. Finish glue cleanup with a damp rag. Weight down the sheets on a flat surface and allow to dry thoroughly.

5. Sand the wing skins smooth with the sanding block.

6. Cut one 7-sheet piece diagonally in two, with untaped side up, as shown by the dotted line marked "A" in the diagram below.

Cut the other 7-piece diagonally in two, with the untaped side up, in the opposite direction as shown by the dotted line marked "B". This provides 4 wing skins with the untaped, rougher glue seam on the outside surface of the wing. The smoother, taped side should be used against the foam wing for best adhesion of the skin to the foam. The rougher, outer glue seams can be sanded down partially with a sanding block before application of the skins and completed during final sanding of the skin on the wing.

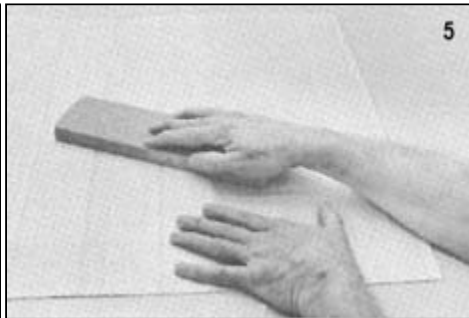
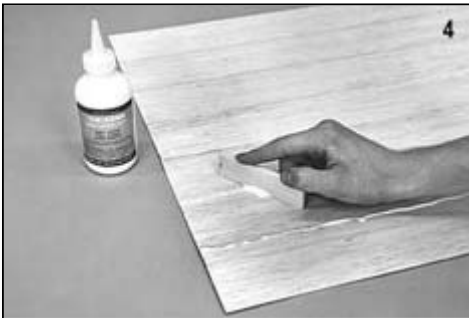

7. Sand any irregularities or cutting wire marks from the cores with the large sanding block.

8. Hold the cores together at the center joint. If there is any mismatch in the airfoil shape, sand as required to make them fit smoothly together. Done this way, little matching will be required after planking.

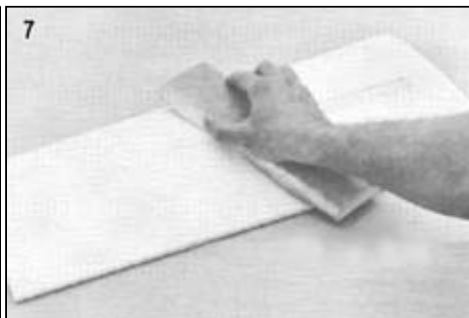
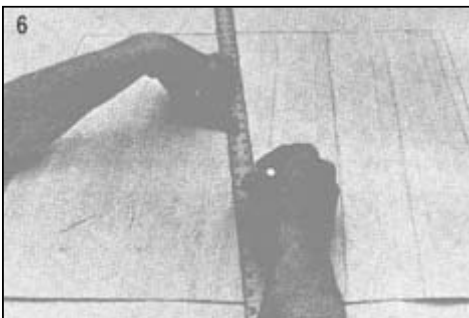

THE SECRET OF A PERFECT FOAM WING

It's a simple matter of a FLAT table. Most tables are not flat, as can be seen by checking them with a good straightedge. If a foam core is covered on a bowed or twisted surface, then the wing will be bowed or twisted. And a table that checks out true but is flexible and will yield as you press on it will also spoil a wing. The ideal working surface is a sheet of plate glass. Or, it is possible to find a thick piece of plywood that is perfectly true.

Like balsa blocks, foam blocks sometimes have built-in internal stresses and the core bows slightly when cut out of the block. Skinning on a flat surface, in the sequence shown in the pictures, will correct minor bows.

Incidentally, the washout in the Kougaur wing is cut right into the foam core. The tip section is higher at the trailing edge compared to the center section trailing edge. The washout will take care of itself. No blocking up or other steps are required of the builder. Proceed with wing construction as if it were a standard wing.

9.
 - a. Sig Core Bond is recommended for applying the wing skins. This is a special adhesive, light and strong, that is ideal for use with foam. As experienced modelers have found, many foam wing glues contain very volatile solvents. When using these glues, if the wing skin is put on before the glue is absolutely dry, the still evaporating solvents are trapped in the assembly and quickly attack and destroy part of the foam core, ruining the wing. Sig Core Bond is much less likely to do this type of damage and is more forgiving of errors in assembly technique. So it is ideal for beginners at foam wing sheeting in addition to being a superior adhesive. Follow the directions on the can for a perfect wing sheeting job.
 - b. Shorten the bristles of an ordinary 2" house paint brush to about 1-1/2". This stiffens the brush and makes it easier to spread the glue evenly.
 - c. Apply a thin, even, full coverage coat of Core Bond to both sides of the foam cores. Avoid heavy spots. These are inclined to skin over, leaving wet spots underneath that could cause trouble after the wings are skinned. Stand the cores on end to dry. (The cores should be coated first because they take slightly longer to dry than the wing skins.)
 - d. Coat the wing skins with Core Bond.
 - e. Allow the cores and skins to dry completely. This generally takes about one hour. In conditions of high humidity it may take somewhat longer. It is best to join the parts soon after they are dry, since if they are allowed to lay around for a long period, they will not stick together as well as if joined soon after they are dry. In case of doubt as to whether the glue is dry or not, it is best to let it dry a little longer rather than join the parts while still partially wet.

CAUTION

Use only Sig Core Bond, Sig Kwik-Set, Sig Epoxy Glue or Sig-Bond Glue on the foam wing cores.

Model cement such as Sig-Ment, dope and fiberglass resin will attack and destroy foam. If you use any product other than those listed, test them on a scrap of foam before use on the wing.



10. Hold the trailing edge of the foam core in position just above the wing skin and lower the edge only onto the skin. Make sure it is properly aligned before contact is made because it cannot be removed and re-positioned after contact is made. Press down along the trailing edge to make sure it is making good contact and is flat against the table.
11. Roll the core down onto the sheet with a rocking motion.
12. Continue rolling the core onto the sheet until the leading edge is attached.



13. Turn the core over and firmly rub down the wing skin sheeting with the flat of your hands to insure that the balsa skin is firmly attached to the core.
14. Remove the waste wood around the edges by rough trimming. Save fine final trim for later.
15. Repeat Step 10 on the opposite side of the cores.

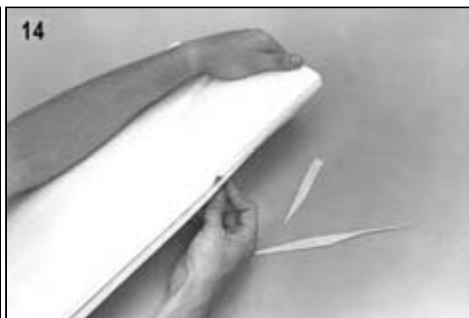

16. Repeat Step 11.

17. Repeat Steps 12 and 13.

18. Trim and sand the edges of the sheeted foam cores. While the regular sanding block can be used, note how useful an extra long block is for this purpose. (The one shown is made from a section of aluminum channel extrusion - with sandpaper glued on using sanding disc adhesive. This handy specialized glue is available at hardware stores and lumber yards.

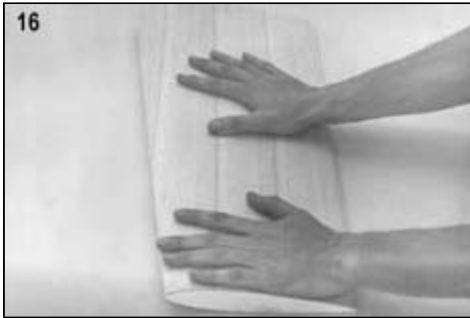

19. Glue on the 1/4"x3/4" leading edge, holding it in place with pins and strips of masking tape. Sig Bond glue is recommended.

20. a. Glue on the 1/4"x1/2" trailing edge in the same manner as the leading edge.
b. Allow to dry.

21. Carve the leading and trailing edge roughly to contour.

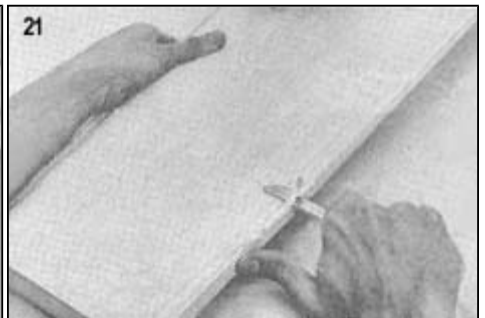
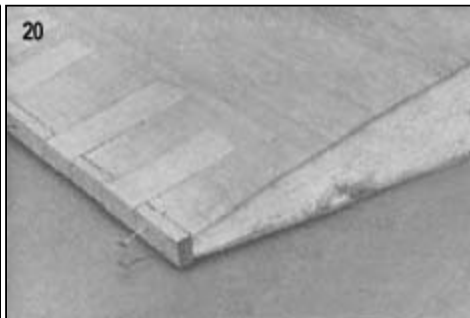
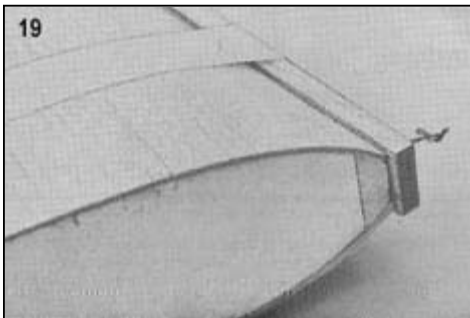

22. Sand to exact shape with the sanding block. A pencil line drawn down the center of the leading edge from root to tip will help get the shape true all along the wing.

23. a. Epoxy glue the anchor block to the grooved block.
b. Cut out the balsa sheeting above the landing gear block slots in the foam core. The slots may be located by pressing on the sheeting or by use of the waste block from the foam core. Cut the holes in the sheeting out undersize at first so that the opening can be trimmed down carefully for an exact fit around the landing gear blocks.
c. Excavate the foam out of the pre-cut cavity to accommodate the anchor block. The best way to cut foam is with a brand new, sharp modeling knife whittling blade. Or you can heat an old blade in a flame and hot cut the hole.
d. Epoxy glue the landing gear blocks into the wing. Should there be any areas in the cavities which do not fit snugly against the blocks, fill these voids with a mixture of epoxy glue and scrap foam which has been crumbled into bits.

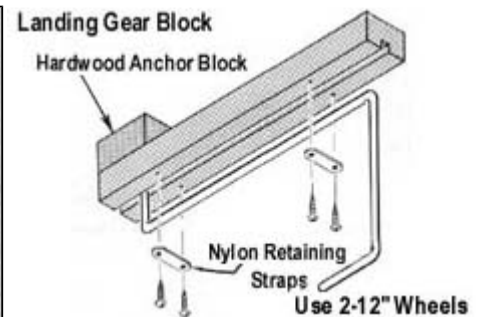
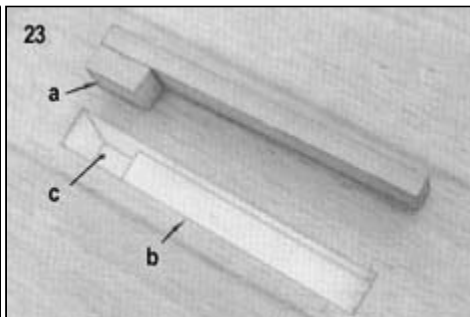
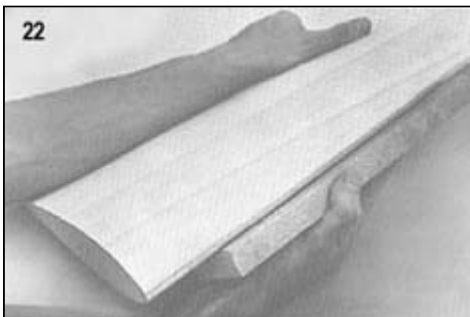

24. Position the landing gear and drill a $5/32$ " diameter hole into the gear block and anchor block.
CAREFUL!
 It is easy to slip and go clear through the wing.

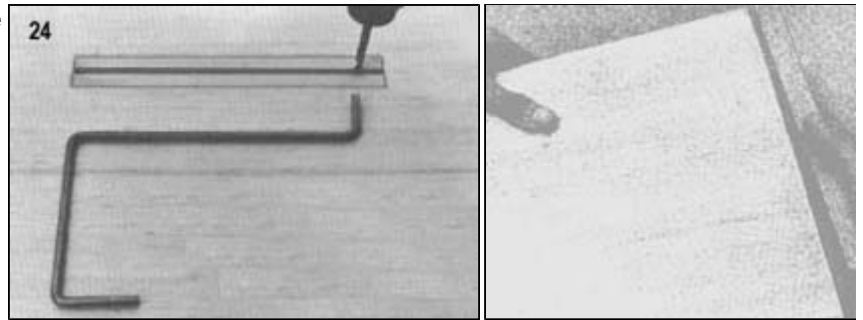

Trim the edge of the hole so that the radius of the wire at the bend will fit down into it. The gear should fit into the block snugly, but tightly that it will jam in the block. You may want to remove it later for straightening after a hard landing. Place a nylon landing gear held on by No. 2 screws across the gear at each end to retain the gear in the groove.

25. The angle already cut into the ends of the foam wing halves sets an approximately correct dihedral angle. To check it, set up the wing halves as shown in the drawing below, with each wing tip blocked up 1". Sand the wing ends (Photo 25) as required to make the joint fit correctly together. Glue the halves together with Sig Epoxy Glue or Sig Kwik-Set Glue. Use plenty of glue where the balsa meets so that the joint between the two halves is completely filled. Be certain that the leading and trailing edges are lined up exact that no twist between the two halves is built into the wing. Mark center lines on the ends of each panel before joining and match them when joining. If you have the wing sitting on a true, flat surface, a further check on twist can be made by putting center marks on them also and measuring from them to the table as a second reference.

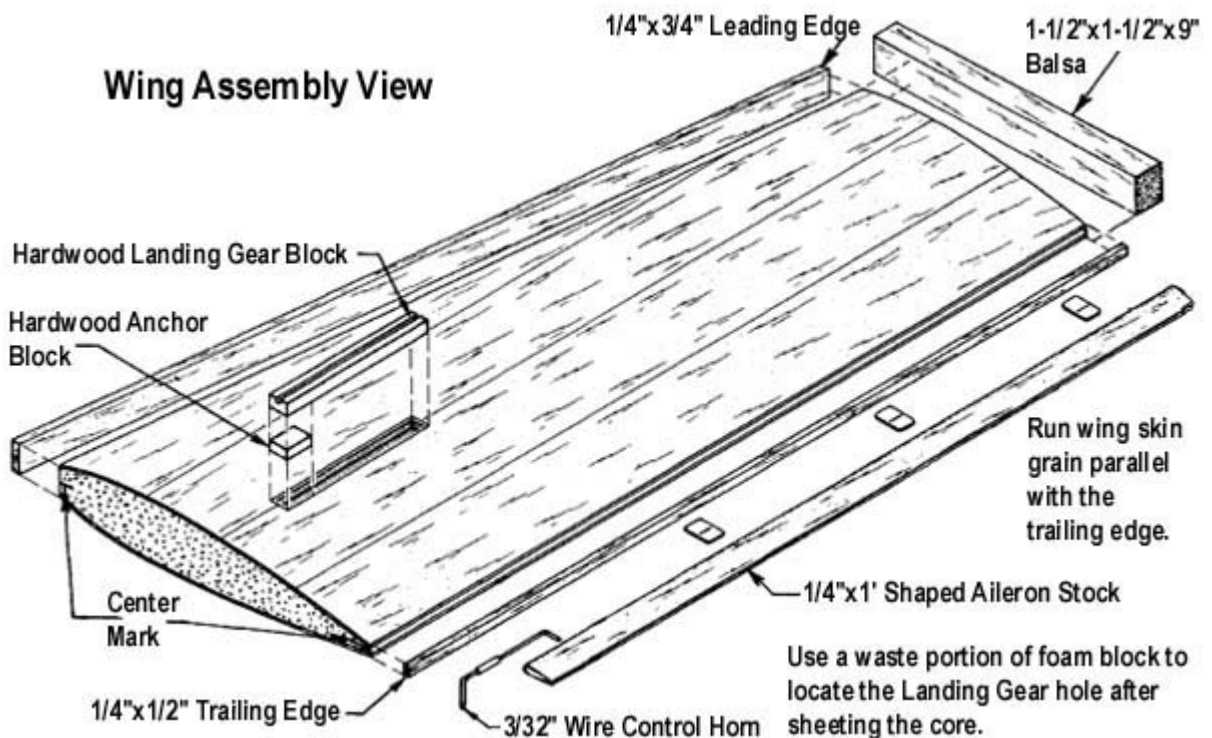
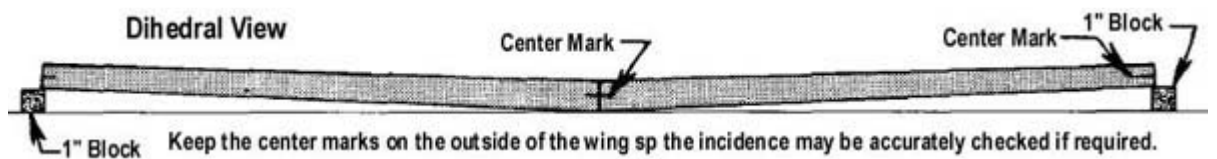

Notes On Loops

A true wing will perform perfect loops. A twisted wing will loop obliquely. One wing half being heavier than the other may also affect loop tracking. Side mounted motor may make one side of the model heavier than the other. Put weight in opposite wing tip until balanced. Should your model snap roll out of the top of a loop, it may snap in the direction of any twist in the wing, but the real reason for it snapping is because of a stall. This is probably due to one or more of the following:

- Airspeed too low.
- C.G. too far back.
- Pilot pulls too much elevator, a mistake aggravated by excessive elevator travel which makes the elevator more sensitive. Reduce travel of elevator and use more care in transmitter stick movement.
- Not enough power, too high a wing loading for the available power or both.

26. Cut out the wing tip blocks, using the pattern, at the end of these instructions, for the top view and the end of the sheeted wing for the side view. Glue the tip block on with Sig Bond, holding it in place with masking tape and/or pins. Carve and sand to shape. (If you wish to save weight by hollowing the tip, only tack glue it in place so that it can be removed for hollowing after it has been shaped. Use an X-acto "Y" router blade for hollowing.)
27. Cut out the inset holes in the wing sheeting for the plywood tabs called PW.
28. Epoxy the PW tabs in place, using a ruler to line them up with the wing top surface.

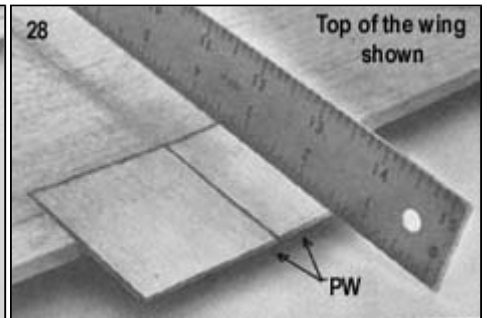
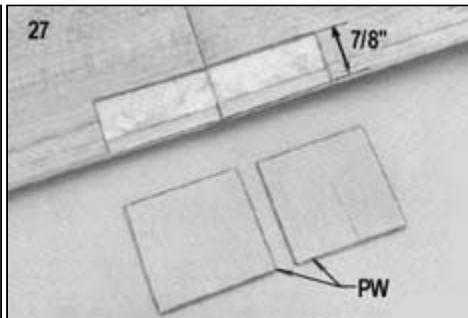
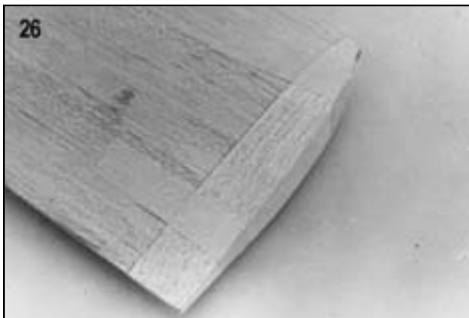

29. Cut the ailerons to length. This should be done right on the model. Groove the ailerons and drill holes for the wire aileron horns. Epoxy the horns into the ailerons.

STOP!

In this picture sequence, the ailerons were covered with silk before they were permanently glued to the wing in Steps 31b. and c. After completing the wing through Step 46, it was covered with silk and the edge of the silk lapped down onto the back of the wing in the crack between it and the aileron. If you are using plastic film covering, it is best to cover both the wing

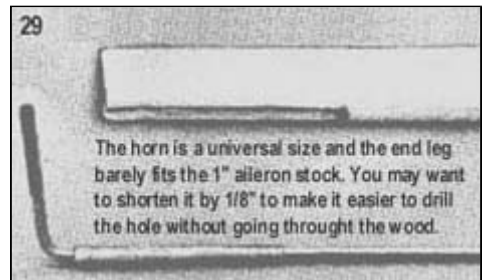

and the ailerons separately before joining because of the necessity of ironing the edges. In this case, DO NOT glue the ailerons to the wing in 31b. and c. Leave them loose and proceed with Steps 32, 33, 34 and 35. SKIP 36,37 and 38 until later. Go on with Steps 39, 40, 41, 42 and 43. Now cover the ailerons and the wing, except for the small area involved in Steps 36, 37 and 38. Now glue the ailerons to the wing as directed in 31b. and c. and proceed with Steps 36, 37 and 38. Complete the job by covering the small area left in 36, 37 and 38 with film.

(You can also use this alternate sequence for covering with silk if you prefer.)

30. Slot the ailerons and glue in the hinges.

- 31.
- a. Cut holes in the PW plywood tabs to pass the arms of the aileron horns.
 - b. Slot the wing to take the hinges that were previously glued into the ailerons. Glue the hinges into the slots. Don't glue the brass bearing yet.
 - c. After the glue on the hinges has set up, position the brass tube bearings and epoxy glue them into the corner formed by the back of the wing and the PW tabs. The brass bearings should not be forced against the back of the wing if they don't happen to be touching it. Let them assume the position they were placed in by the gluing in of the hinges. If there is a slight gap between the tubing and the wing, allow it to fill with epoxy glue.

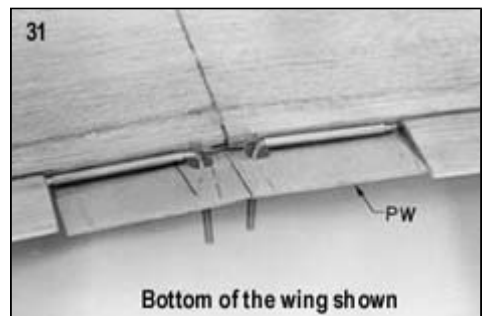

INSTALLING EASY HINGES

Using a No.11 X-Acto blade (or similar) cut a slot approximately 1/2" in depth and slightly wider than the hinge. After all slots have been cut, insert an Easy Hinge halfway into each slot in one of the pieces to be hinged. Then carefully slide the matching model part onto the other half of the hinges. You'll find it easiest to slide the part onto the hinges at an angle, one hinge at a time.

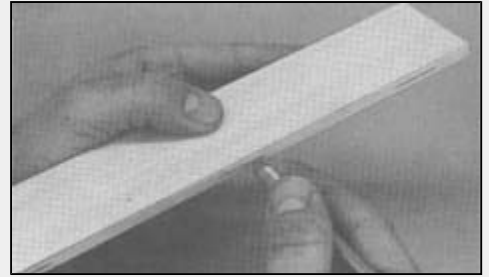

At this point the surface to be hinged is attached but not glued. Align the two surfaces and adjust the gap between them as required. For best control response, the gap should be as small as possible but big enough to allow the control surface to move to the maximum deflection that you will require. Place three or four drops of any brand of cyanoacrylate adhesive (thinnest variety) directly onto the Easy Hinge in the gap.

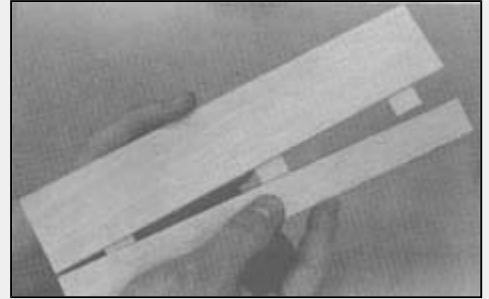

You will notice that the glue is quickly wicked into the slot as it penetrates both the wood and the hinge. Continue this process, gluing the same side of all of the hinges. Then turn the surfaces over and repeat the gluing process on the other side of each hinge. After the glue has cured, approximately three minutes, the joint can be flexed. You may notice a slight stiffness in the joint. This can be eliminated by flexing the surface to full deflection each direction a couple of dozen times. Don't worry about shortening the life of the hinge as they are almost indestructible.

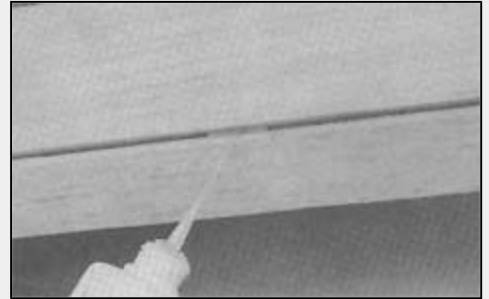

AT THIS POINT YOU WILL NEED THE FUSELAGE COMPLETED THROUGH STEP 73.

32. (NOTE: Picture 32 shows the fuselage bottom block in place on the fuselage but it is best NOT to have it installed when Step 32 is done. Access to the dowels is, much easier when it is not in the way.)
- Set the wing in the fuselage saddle. If it does not fit the saddle exactly, sand as required to make it fit.
 - Hold the wing in position and mark the dowel holes in the wing by punching through the holes in F-2 with a 1/4" drill, a piece of tubing or a rod.
 - Drill the holes in the wing out oversize - about 9/32" diameter - to allow some "wobble" room during the final positioning and gluing in of the dowels. Dig out a little foam just behind the leading edge so the glue will form a "collar" to lock the dowel to the balsa.
 - Put a piece of wax paper over the face of F-2 and insert the dowels through the paper into F-2.
 - Coat the holes in the wing with Kwik-Set Glue and put enough extra glue in the holes to fill the gap between the oversize holes and the dowels. Don't overdo the amount of glue.
 - Put the wing in place and secure it in position with masking tape. Hold the fuselage vertically to keep the glue from running out of the dowel holes. Allow the glue to set up firm, but not fully cure, just in case it may have stuck the wing to the fuselage in some leaky spot. Remove the wing. If the dowel holes are not completely filled with glue, fill them. If necessary, now that the dowels are set in place, you can cut away the wood around them to provide room for filling any remaining crack with glue.
- 33.
- Put the wing on the fuselage again with a piece of wax paper between it and the fuselage at the back.
 - Epoxy the wing bolt anchor blocks in place against the fuselage sides.
- 34.
- Locate the positions of the wing bolt anchor blocks on the bottom of the wing. (Remember that the wing bolt holes are drilled at an angle so that the heads of the bolts will end up flush with the surface of the bottom of the wing.
 - Drill a hole through the wing and on through the anchor blocks with a No.7 drill. (13/64" is the nearest inch size equivalent.)
 - Run a 1/4-20 tap through the hole to cut threads in the wing bolt anchor blocks.
 - Remove the wing and drill out the holes in the wing only with a 1/4" diameter drill to pass the nylon wing bolts.

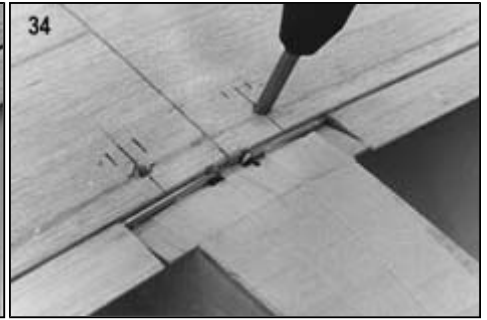
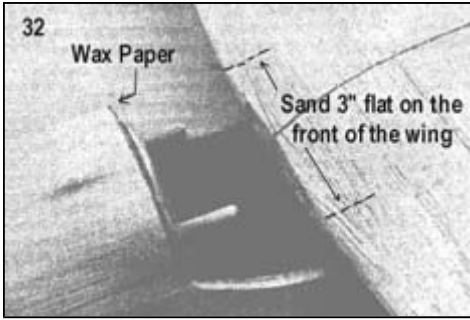

NOTE:

If you are in a hurry to get the model built and aren't interested in a perfect bottom line contour between the wing and fuselage, ignore Steps 35 and 36. Look ahead to Step 37 for an explanation of a simplified wing bolt hole reinforcement.

35. Cut out inserts for the 1/16" plywood PB squares and drill 1/4" diameter holes through them from the other side of the wing. Epoxy glue PB in place.

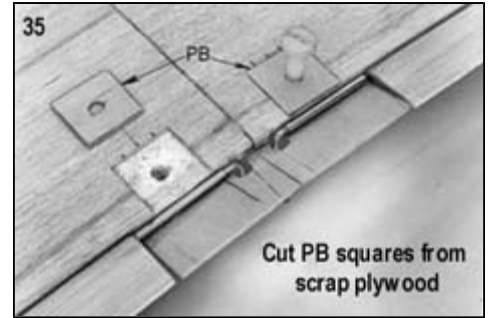

- 36.
- Cut and notch pieces of 1/4" shaped trailing edge stock to fit over the brass tubing bearing of the aileron horns.
 - With a tooth pick, coat the inside end of the tubing with vaseline to prevent any glue that may accidentally be squeezed onto it from sticking the horn movement. It is only necessary to grease the very end and a small section of the wire. Do not grease the whole tubing -- it should be epoxied to the shaped piece.
 - Epoxy the shaped 1/4" trailing edge stock in place.

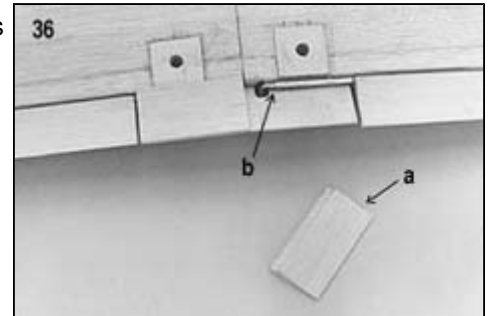

37. Cut pieces WS from 1/8" sheet and glue in place.

SIMPLIFICATION NOTE:

If you skipped the inset pieces PB in Steps 35 and 36, use the pattern called WSS to cut substitute pieces from scrap 1/16" plywood. Glue these WSS pieces over the holes directly on top of the balsa skin without cutting any inset. Drill through them from the opposite side of the wing. If plywood pieces WSS are substituted, remember that they cannot be shaped to contour as are the balsa WS pieces done in the next step.

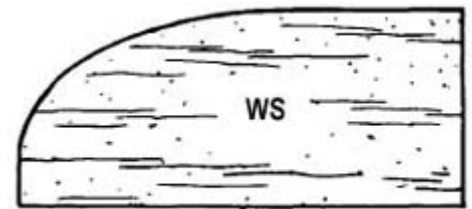

3/32" Scrap Balsa

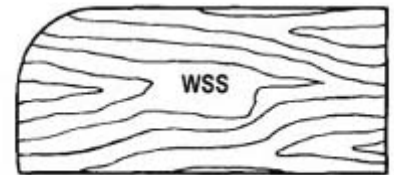

1/16" Scrap Plywood

- 38.
- Protect the bottom of the fuselage from the sanding block with a piece of light cardboard that will slide back and forth as the wing is shaped.
 - Sand the 1/4" trailing edge stock and the pieces WS to form a smooth connection contour with the bottom line of the fuselage.

- 39.
- Put a piece of wax paper between the wing and fuselage (which now has the bottom front block installed and shaped) at the front.
 - Shape a piece of scrap balsa block to fit down into half of the cavity. Make a matching block for the other half.

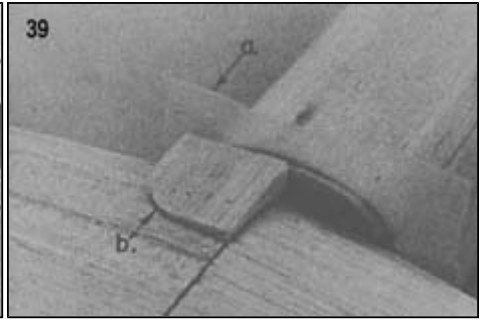
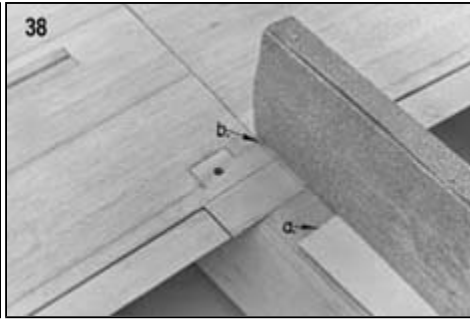
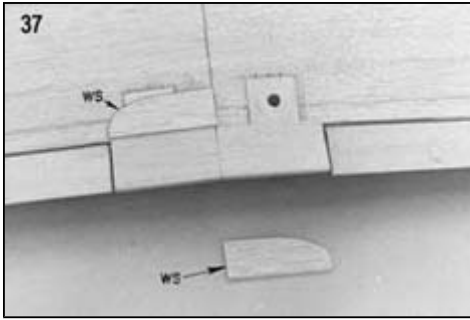

40. Carve the blocks roughly to shape so that the contour of the fuselage bottom block is carried on to the wing.
41. a. Glue the blocks to the wing and fine sand the shape as shown.
b. Fill any small remaining gaps with Sig Epoxolite or a mixture of Sig Kwik-Set glue and micro-balloons or talcum powder.
42. a. Cut a cavity in the wing for the servo. Size will depend on the servo and/or mount. Look ahead in the book for further ideas on the requirements for this hole.
b. Cut strips of 2" fiberglass tape for both sides of the wing center joint.

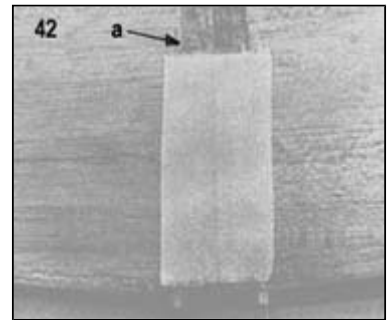
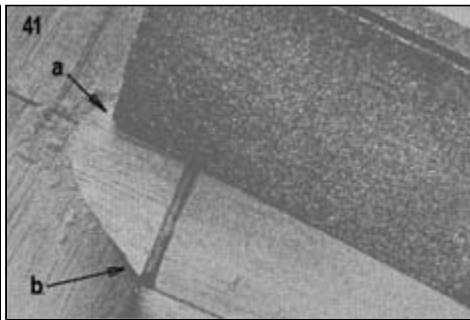
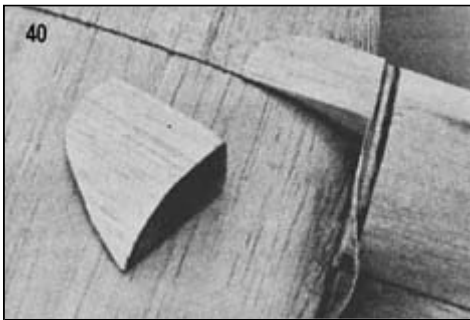

43. We use regular Sig Epoxy Glue (not Kwik-Set Glue) for applying the fiberglass tape, since it is thinner and easier to spread out smoothly. It will be even easier to spread if you warm the mixing container by setting it in hot water for a few minutes to raise the temperature of the glue. But work quickly, for the glue will set up much faster than normally when warmed.
- a. Coat the wing center with glue.
b. Lay the tape on top of the glue.
c. Holding one end of the tape so it won't slip, "squeegee" the glue through the tape, with a small paddle made from a scrap of balsa. Scrape over the tape several times with the squeegee paddle to smooth the tape and remove excess glue.
44. Glue hardwood mounts for the servo into the cavity. Coat the entire inside of the cavity with epoxy glue to prevent the foam from being damaged by fuel or dope.
45. The plastic servo mount in the photo is for a Logictrol servo. Use No. 2 screws to fasten it to the hardwood mounts. For more radio equipment installation instructions look ahead.
46. a. Screw the nylon connectors supplied in the kit onto the threaded aileron horns.
b. Hook the servo to the aileron horns with the rods and HC links.
c. A servo connector can be used at the other end instead of a "Z" bend, if desired. The SIGSH184 connector is shown here but is not furnished in the kit.

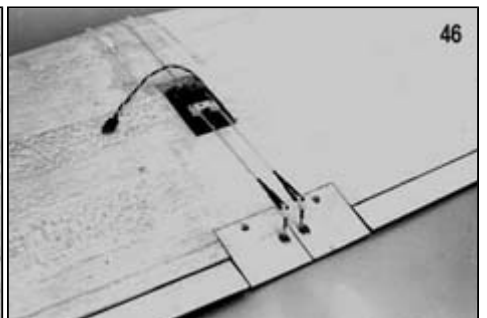
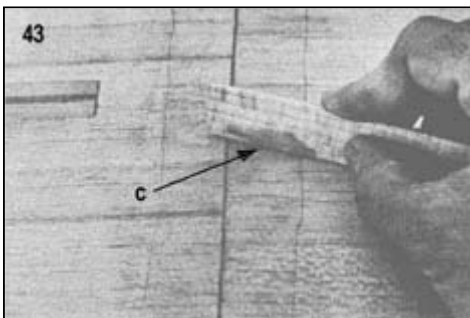

FUSELAGE CONSTRUCTION

NOTE:

Vertical or side mounting may be used, but the tank position should be changed accordingly to keep it in the same relationship to the motor's needle valve hole.

47. Smooth and even F-1A and F-1B with the sandpaper block. Glue them together with epoxy glue, as shown in the accompanying drawing.

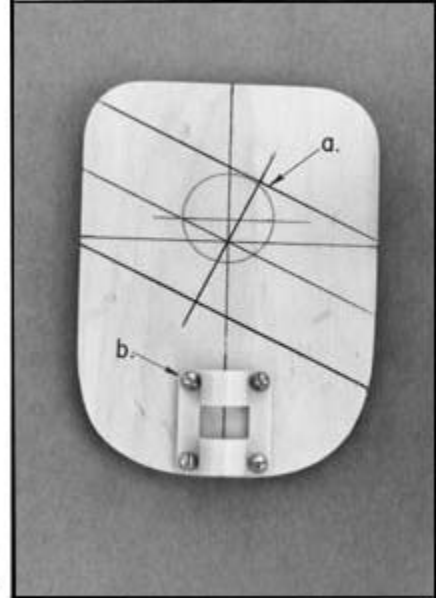
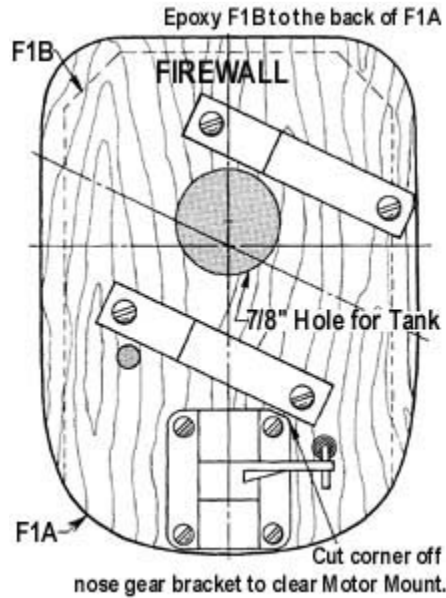

48. The angled motor mount installation was chosen for the Kougat to get the fuel tank in the optimum location in the fuselage and at the same time provide for installation of a standard type of muffler at a practical point in relation to the fuselage. Different motors may require different spacing than that shown.

- a. Layout the center lines and motor mount positions on the front of the F-1 firewall assembly, using the F-1 drawing as a guide.
- b. Position the nose gear bearing and drill holes for the 4-40 bolts.

- 49.
- a. Tack glue the motor mounts to the firewall. Bring the glue up over the mount ends to help hold it. (Double coated masking tape can be used instead to attach the mounts.) Check and see if your motor fits properly on the mounts.
 - b. Drill through the mounting holes with a long drill bit. (If you do not have a long drill bit, a length of music wire with a notch filed in the end will do the same thing.) Or--start the holes using a tap holder for a drill bit as shown.
- 50.
- a. Enlarge the holes just drilled in the back side to take the shank of the 6-32 blind nuts on the mounts and the 4-40 blind nuts for the nose gear bearing.
 - b. Tighten the mounting bolts to pull the blind nuts into the wood. Coat them with epoxy glue to hold in place.
 - c. Drill a 7/8" hole through the firewall for the tank. (If you don't have a 7/8" wood bit, the hole can be cut out on a jig saw. Or, drill a series of small holes around the edge of the large hole, punch out the center and finish the edge with a sanding drum in a motor tool or with sandpaper wrapped around a dowel.

Motor Mounting Notes

When tapping holes in the aluminum motor mounts, use kerosene or a specialized aluminum tapping lubricant such as Tapmatic Fluid, rather than oil. This will reduce the chance of the tap sticking in the motor mount and breaking. SIGSH109 6-32 x1" Socket Head Bolts are recommended for mounting the motor. They are not furnished because some builders may not have a tap. Use SIGSH159 bolts, nuts and washers in this case.

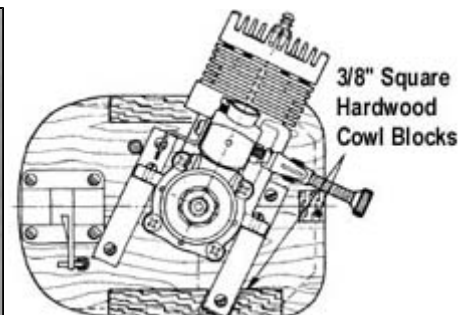
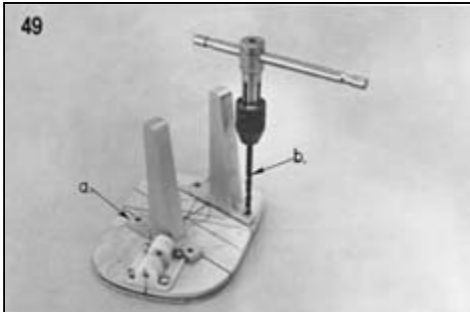

51. (NOTE: The photo shows the Kavalier firewall, but the process is the same for the Kougar.)

- a. Bolt the spinner backplate to the motor. (This must be done to allow for differences in spinners. For example, the Goldberg spinner has a recessed backplate which requires the motor to be farther forward than a spinner without a recess. This is a good thing, giving more clearance behind the motor for fuel lines, and is one reason - other than the pleasing shape - that we recommend the Goldberg for the Kougar.)
- b. With 5 minute epoxy, tack glue the engine to the mounts so the back of the spinner is 4 1/2" from the front face of the firewall. (This allows for approximately a 3/32" space between the cowl and spinner.)
- c. Make a punch by sharpening the end of a piece of 1/8" music wire.
- d. Center punch the mounting holes.

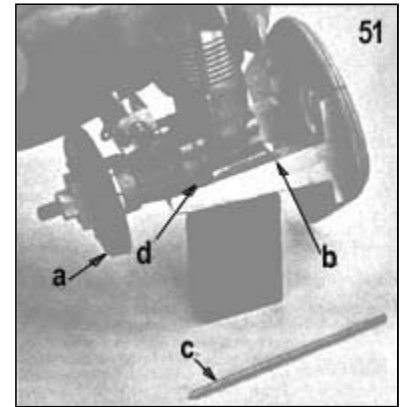

The recommended method of engine mounting The recommended method of engine mounting is to tap the motor mount holes and use 6-32 socket head bolts to retain the motor. Back the top out frequently and clean to avoid jamming in the aluminum. Use kerosene or a special aluminum tapping lubricant. If you do not have a tap, drill holes through the mounts and use bolts, lock washers and nuts.

52. Sand off the rear ends of the fuselage printed sheets.

53. Glue the fuselage end pieces FX-F2 and FY-F2 to the end of the fuselage sheet. Use a ruler to make sure the top line (where the stabilizer will be mounted) is straight. Mark the thrust line on the end of the fuselage side where it can be located later if needed for incidence check or for parallel decorations. (Also do the nose.)

- a. Glue the top 1/2" triangular stock top pieces on to the fuselage sides.
- b. Glue on the back bottom piece of triangular stock.

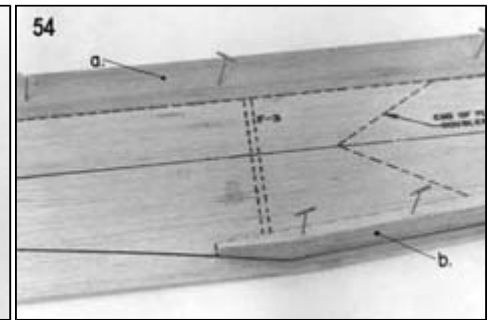
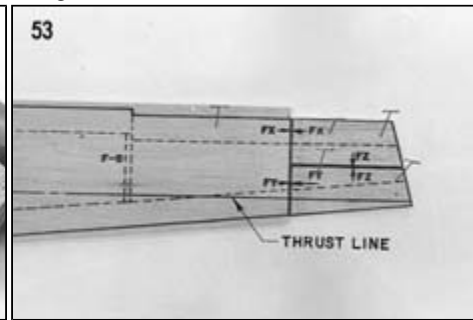
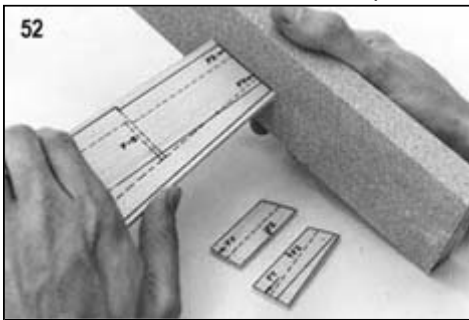

55. a. Add the piece of triangular stock just under the stabilizer position.

56. a. Glue on the bottom front piece of triangular stock.

- b. FW is cut from scrap 1/16" sheet using the accompanying pattern.

57. Glue FW in place.

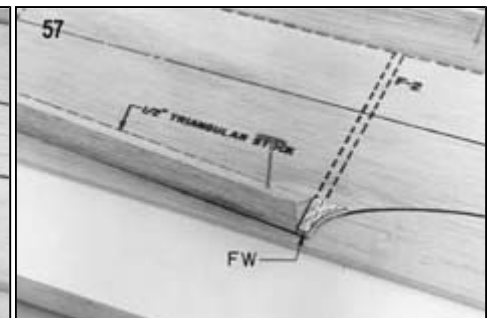
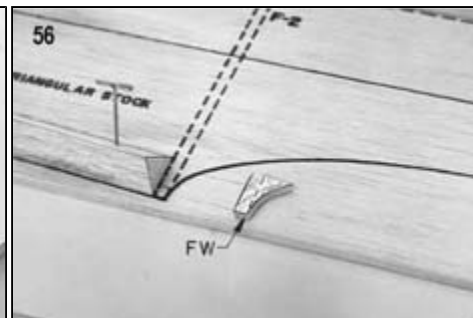
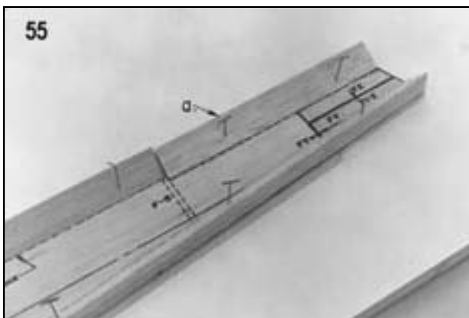

IMPORTANT NOTE:

Do not use Sig-Bond, White Glue or any other water-base adhesive to glue the plywood doubler to the fuselage sides. The water in these glues causes the parts to curl. Use Sig Epoxy or Sig Kwik-Set. Only a thin film of epoxy glue will be necessary. Sig Kwik-Set sets up in under 5 minutes so you must work rapidly when using it.

58. Mark the locations of Formers F-2 and F-3 on the triangular stock because the doubler will cover up the location lines.
59. Fit the die-cut plywood doublers into place. Sand wherever necessary to make them sit in the proper location. Leave the black line of the wing saddle area --- don't cover it with the doubler.

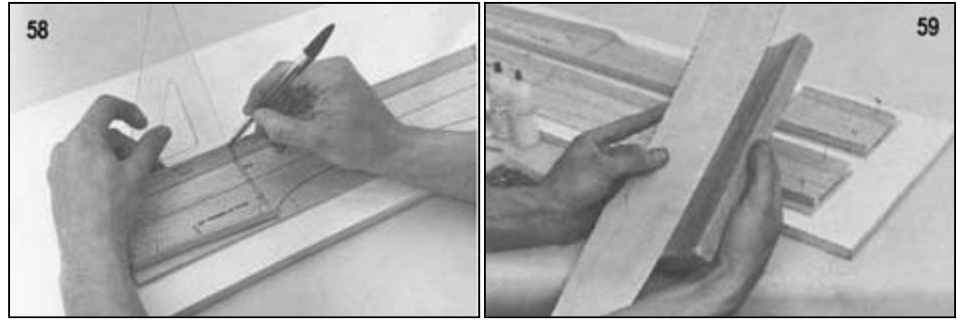

CAUTION

Do not glue the plywood doublers, on with Sig Bond, Tite Bond, Elmer's white glue or any other adhesive that has a water base. Water base glue will cause the doublers and sides to curl because of the large area being glued.

The doublers on the prototype were glued in place with Sig Kwik-Set five minute epoxy. Work quickly, spread a thin film of glue over the entire doubler, put in place and press down with your hands while it is setting up. Do not take it from the building board immediately after setup. Five-minute epoxy sets up quickly but doesn't fully cure for some hours. During this time it can warp. Put some heavy weights on the doublers and leave them overnight if possible.

Some builders prefer contact cement to install doublers. The main consideration here is to prepare guides beforehand with pins placed so they will steer the doubler onto the exact required spot, for once the glue on each surface makes contact, the doubler cannot be moved. Another aid makes contact, the doubler cannot be moved. Another aid is to cut a piece of wax paper to cover the glue on the side and slip it out when the doubler is in place. Press the parts firmly together.

60. Cut the completed sides from the sheet.
- 61.
- Mark the positions of F-2 and F-3 on the plywood doublers.
 - NOTE: It occurred to us after doing the photo sequence that the notching of the bottom triangular stock to pass F-1B could more easily be done at this point. Look ahead to picture No. 72 and you may agree and want to do the notches now.
 - Cut pieces of triangular stock for the fuselage front. Allow 3/32" back from the front edge to accommodate F-1B. DO NOT glue these pieces in at this time. Put them aside for later use after the firewall has been glued on.

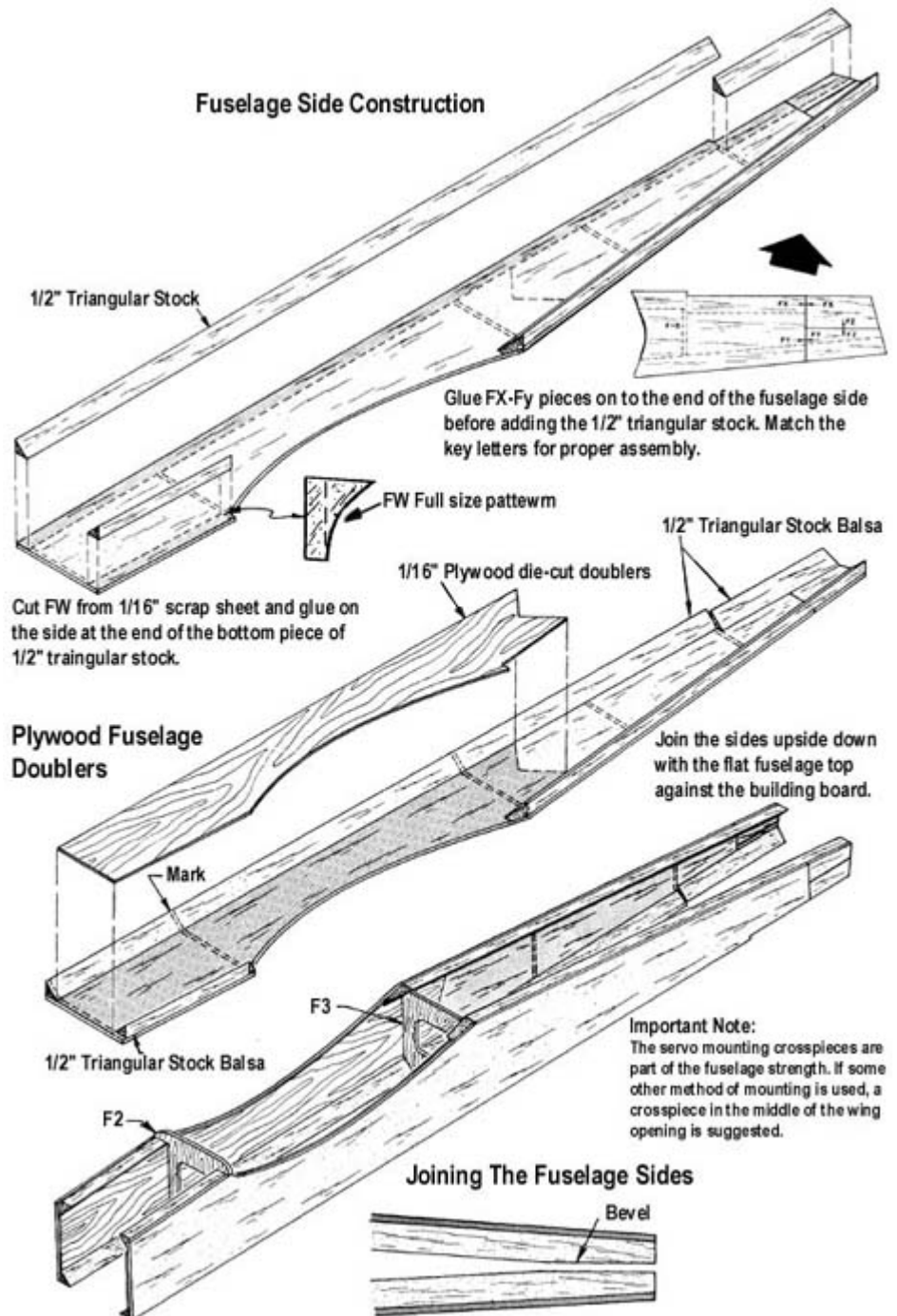

62. Notch out the plywood doubler and side as required to pass the motor mount blind nut later when the sides are joined.

63. a. Using the pattern, drill 1/4" holes in F-2.
b. Check the dowels in the holes. They should fit snugly but not so tight as to be difficult to remove. Sand the holes as required to make the dowels come out without a lot of force.

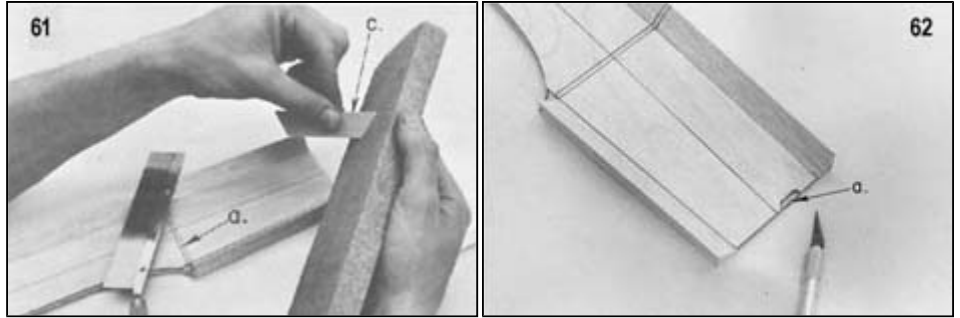

64. At this point check the top view plan of the rear of the fuselage and look ahead to picture No. 71. They show the bevel that should be cut into the triangular stock now so the rear ends will fit together when the sides are joined later.

65. Glue F-2 and F-3 in place on a side with epoxy glue. Use a 90° triangle to get them exactly perpendicular.

66. Pin the side on the top view plan - see the end of the instructions.

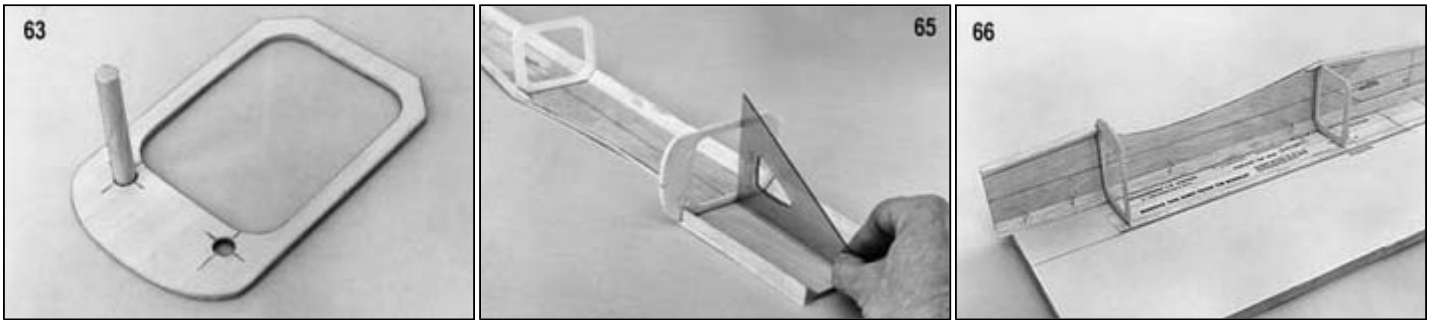

67. Join the other side to F-2 and F-3. Pin securely to the building board.

68. Glue F-4 in place, holding the fuselage pinched together while pinning the sides to the building board.

69. Continue on back along the fuselage, gluing in F-5 and pinning the sides to the building board.



70. Pinch the sides together at the back. Glue and pin.

71. Add FB to the back of F-3. The edges of FB will have to be beveled to fit against the triangular stock.



72. Saw a notch in the bottom triangle stock, flush with the plywood doubler to accommodate F-1B.
73. a. Sand the bottom of the fuselage smooth and level with the sanding block. (As is shown being done to the fuselage top in picture No. 79.)
 b. Cover the bottom of the fuselage with pieces of 1/8" sheet.

IMPORTANT! Leave the sides pinned down to the board until after the bottom sheeting is glued on and is dry. If the sides are removed from the board before the bottom sheeting is on, the fuselage may twist if one side happens to be a different grain of wood than the other. After the bottom is on, it will remain perfectly true and can be removed from the board.



74. Use scrap triangular stock to brace the wing bolt anchor blocks, which have just been installed during the performance of Steps 32 and 33 of the wing construction.

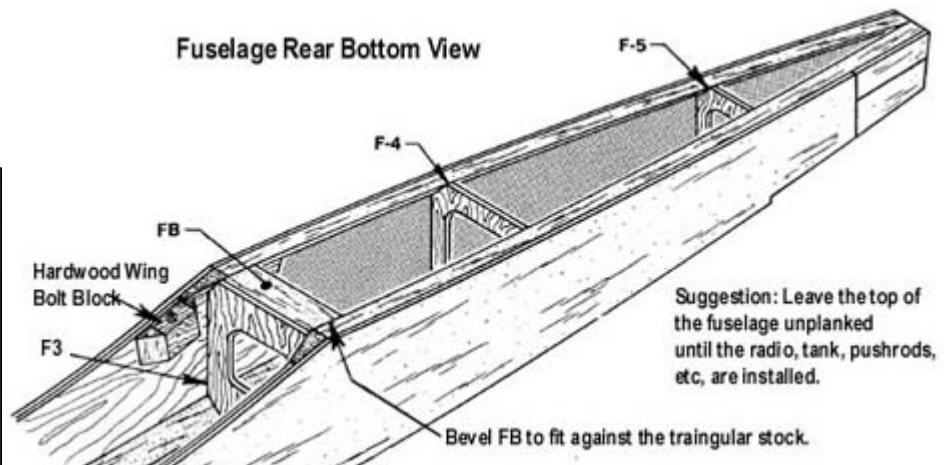

STOP! Don't proceed any further with the fuselage until it has been used for Steps 32, 33 and 34 on the wing.

75. Fit the 3/4"x3" bottom front block in place, with firewall taped on.

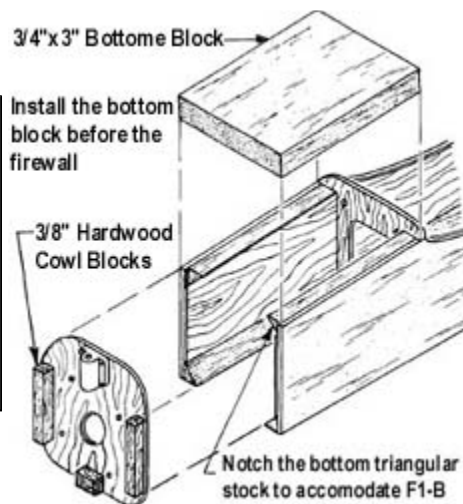
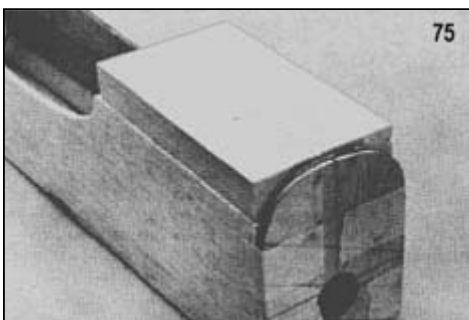

OIL PROOF YOUR MODEL!

One of the most destructive things that can happen to a model is allowing engine oil to soak into bare, untreated balsa or plywood. It will cause glue joints to loosen and results in a steady increase in weight. An oil soaked model cannot be properly repaired or re-painted after a crackup, since glue and finish will not hold. Cover all wood parts of the model and put on enough coats of finish so that oil cannot soak in. Don't leave any exposed wood on the outside. Around the nose and engine compartment, apply extra effort at oil proofing. Coating the firewall and front joints with epoxy glue is best, but several extra coats of dope or paint will also do the job. Take special care during building to use plenty of epoxy glue to attach the firewall and coat the back of the firewall and the firewall braces with the glue. Fill any cracks with epoxy.

76. Hollow out the block to make more room in the nose for a battery.

77. a. Cover the holes in the blind nuts on the back of the firewall with small pieces of tape to prevent glue from oozing into the threads. (Look ahead to Picture No. 80.)
- b. Epoxy the block and firewall to the fuselage.
- c. Shape and sand the block to the contour formed by the firewall and F-2.

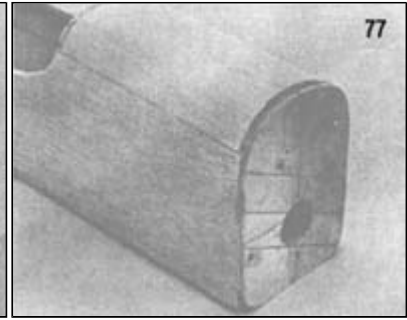
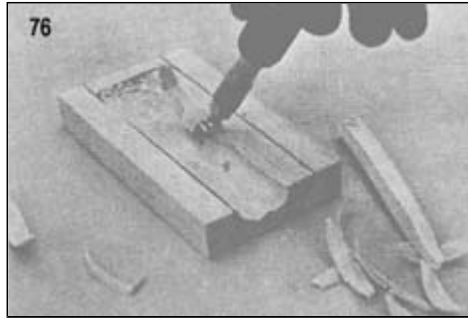

Assemble the tank for use during Steps 78 and 79.

TIPS ON TANKS

IMPORTANT: To prevent fuel spray from staining the canopy, run the tank vent line out of the bottom of the cowling. Fill the tank through the muffler pressure line or needle valve line.

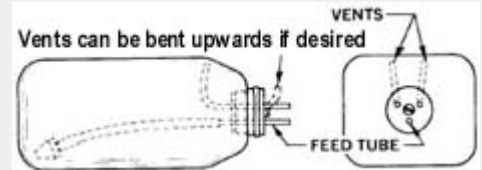

We occasionally receive suggestions from builders that a removable hatch be designed into the model for access to the gas tank. Our opinion is this is not the best method in most cases. The hatch opening makes the nose weaker and there is no good way to keep oil leaking in around the hatch. A method of fastening has to be built into the fuselage to hold a hatch in place.



Modern plastic tanks are virtually indestructible under normal use and bursting or cracking is almost unknown. If you use Sig Heat Proof Silicone tubing (which will not harden or deteriorate in fuel) in the plastic tank, the tank will seldom have to be removed. We have models in which tank has been installed for three or four years without ever needing removal. So it is quite practical to put the tank in semi-permanently. Check the models at a contest - you'll find that the majority have sealed noses, as does this kit.

Read this before you drill the 7/8" hole in the firewall.

Some fliers prefer not to bring the tank cap through the firewall as is shown in the construction sequence in these instructions. Instead they drill two holes for the vent tubes only and make the vent tubes long enough to extend through the firewall. This method requires little sealing but it is more difficult to install and remove the tank. The best way to manage this is to feed long pieces of fuel line through the holes and attach them to the tank in the cabin area. Steer the tank into the nose as the tubes are pulled back through the holes. If you are undecided as to which method you should use, our advice is that large hole installation shown in the construction pictures is the best for beginners.

Put scrap wood supports under and at the back of the tank. The front is supported by the 1/4" hole in the firewall. Seal the tank cap in the hole with G.E. Silicone Bathtub Seal (available at hardware stores) or Devcon Seal-It. Put an oil-proof finish on the firewall and in the hole before sealing the tank cap. Get some of the sealer on the sides of the hole and also put a bead over the edge of the cap at the front. Should you need to remove the tank, break out the scrap wood supports in the rear and push out the silicon rubber seal around the front cap. Reach into the fuselage and guide the tank outside.

Some builders, after putting their receiver battery in a plastic sack, taping it shut, wrapping it in a foam rubber package and stuffing it into the nose under the tank, then stuff paper toweling or foam rubber in to fill the nose compartment and keep everything firmly in place.

After installation, put fuel tubing on the vent tube and run it to the outside of the cowling on the bottom, so that fuel overflow is not blown over the wing-fuselage joint, where it may leak into the fuselage. The best way to fill the tank is to take off the fuel line to the needle valve and pump the fuel in there until it runs out the vent. Be sure and use a filter on your fuel supply can, and it is a good idea to have a filter between the tank and the needle valve also.



Pressure Feed

If the engine you are using is equipped with a muffler pressure tap, make use of it for a more even fuel feed and reliable operation. The hookup for pressure feed is shown in the picture. To fill the tank, remove the fuel line from the engine and pump the fuel in. When the tank is full, it will overflow through the muffler pressure line. Use transparent or translucent fuel line so you can see the fuel starting to overflow when the tank is full. Should some fuel happen to get in the muffler, drain it out before starting the engine. Do not try to fill the tank in reverse from the pressure line, the tank will not fill properly and fuel may be forced into the engine.

NOTE: Photos 78 and 79 show the Kavalier fuselage, but the procedure is exactly the same for the Kougar.

78. Practice installing the tank to make sure that it can easily be passed from the radio compartment of through the tank cap hole in the firewall. Modify anything that interferes with easy placement and removal of the tank.
79. Glue scrap blocks on each side of the tank and at the rear end to hold it in position. Don't get the blocks too tight, just enough to keep the tank from rattling around. The tank will need to be removable after the fuselage top is on by pulling on it from the bottom side. Hold the tank in place with temporary scrap crosspieces across the bottom and the back. They can be broken out when necessary to take out the tank. Or, you can stuff paper or foam rubber and the battery under it for support. This is a good time, while access to the nose is open, to install the radio equipment and the pushrods for the steerable nose wheel and throttle. SIGSH559 cable and tubing pushrods are recommended. The nose compartment can be oilproofed at this time by painting it with warmed Sig Epoxy Glue (See Paragraph No. 43).
80. a. Reach through the top and epoxy in the triangular firewall braces that were cut to fit previously in Step 62c.
b. Cut a top triangular brace to fit and epoxy in place.

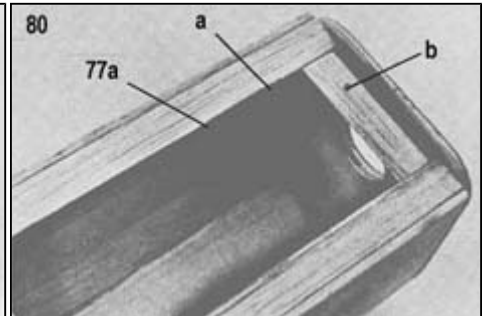
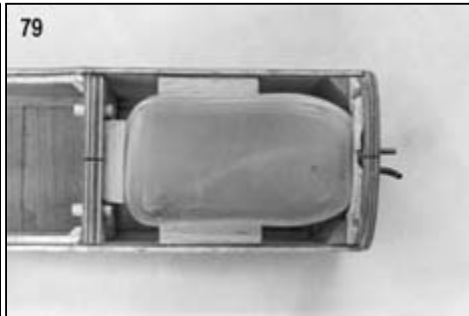
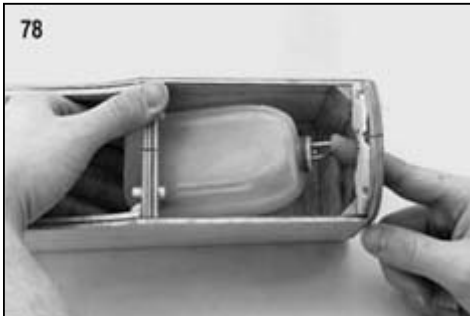

81. Sand the top of the fuselage level and smooth.

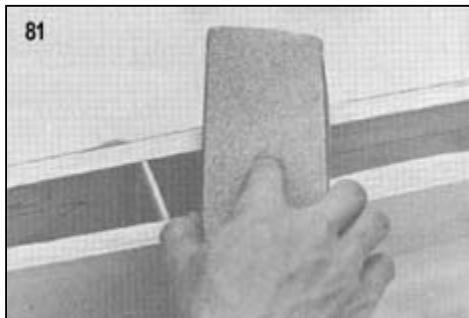

82. Glue pieces of 1/8" sheet to the top of the fuselage.

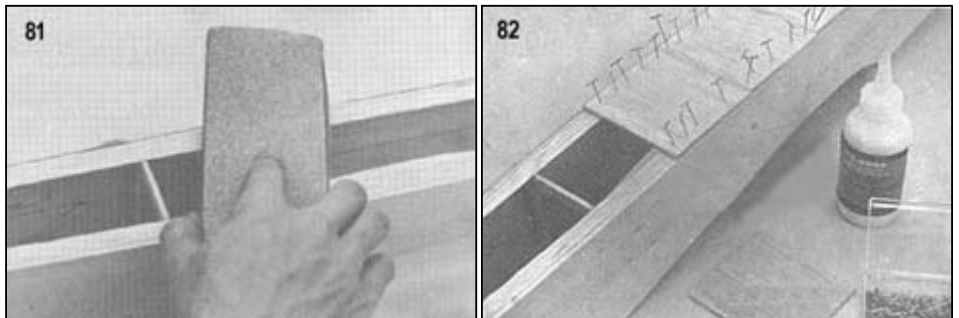

STOP! At this point you will need the tail parts.

83. a. Fit the plastic turtle deck and canopy to the fuselage. The canopy must be trimmed down as required along the bottom to fit down snugly on the plastic turtle deck. Temporarily tape the tail, plastic turtle deck and canopy in place on the fuselage.
b. Outline the position of the plastic turtle deck and canopy on the top of the fuselage with pencil.
c. Round the corners of the fuselage with a modeling knife. Note that the fuselage cannot be rounded quite as much next to the canopy as it can elsewhere, because the canopy is close to the fuselage edge.

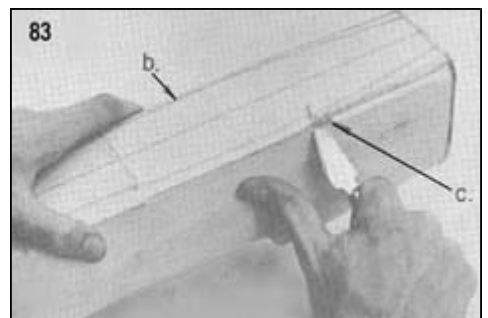

84. Pin 1/8" square balsa pieces to the top as mounting rails for both the canopy and turtle deck. Allow for the thickness of the parts.

85. Taper the 1/8" sq. pieces so the canopy will fit snugly down on them.

86. Paint the canopy before gluing it on (see "FINISHING THE PLASTIC") but do not leave it laying around painted. Put it on soon as the paint is dry. The rest of the model should be completely finished before the canopy is attached. Sigmant glue, used sparingly, will fasten the canopy to the gluing rails. "Super" cyanoacrylate type glues may also be used. Careful! Too many fumes from the glue trapped inside may fog the canopy. Put a ventilation hole into the cockpit floor and proceed slowly.

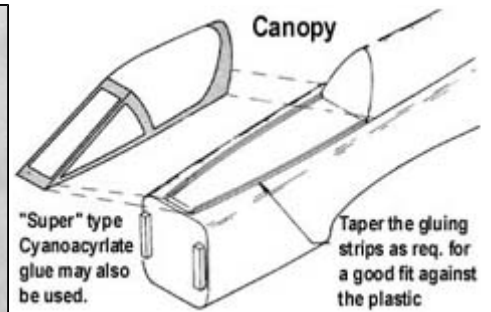
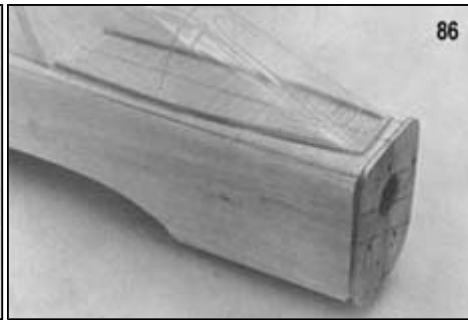
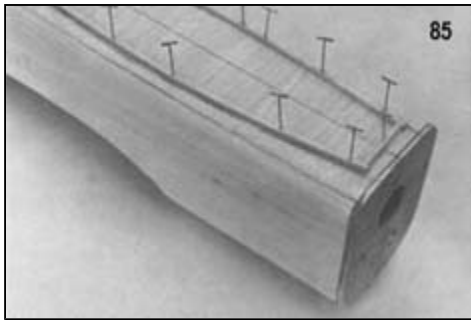

REAR DECK AND TAIL ASSEMBLY

Note: The stabilizer and rudder parts are easiest to cover before they are hinged and attached to the fuselage. Refer to the Finishing section and prepare the tail parts before hinging and attaching to the fuselage. Test assemble them on the hinges before covering to insure that a good edge and end match has been obtained in the sanding operation.

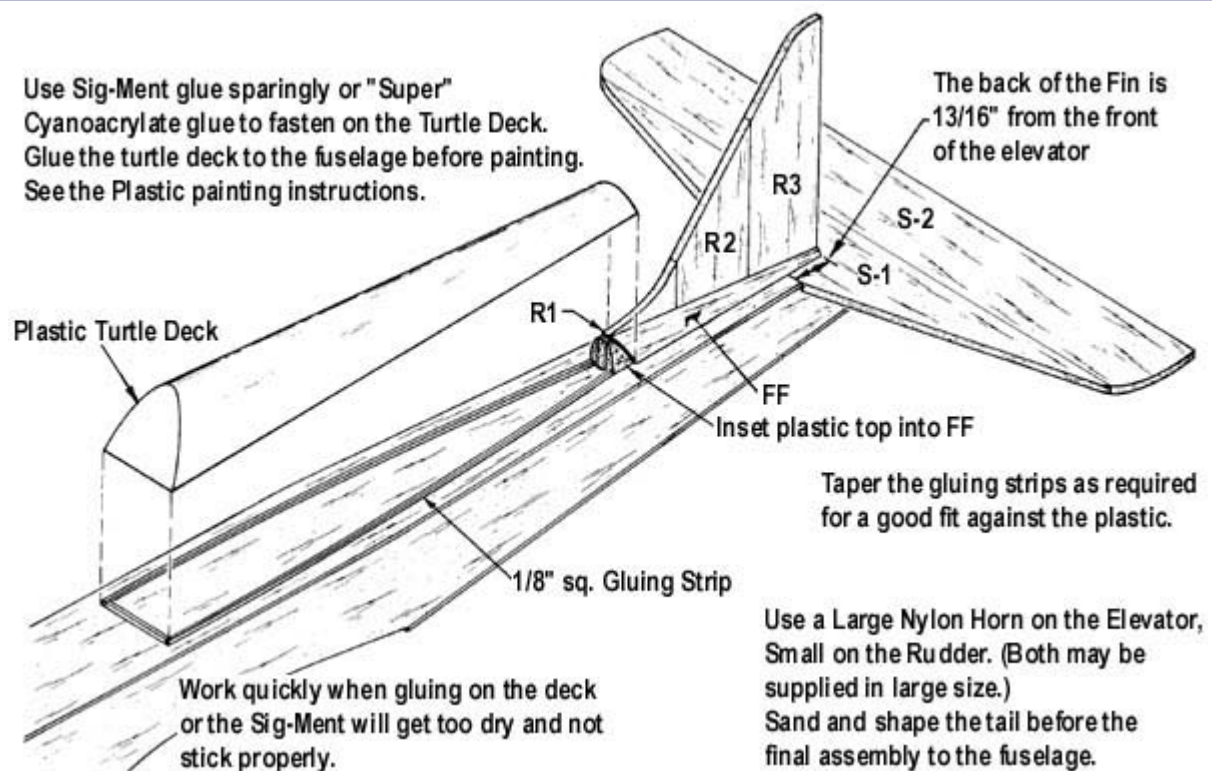

87. Saw out the tail parts. Fit them together, using the sanding block. Glue and pin down the wax paper.

- 88.
- Sand off the lines and round the leading edge of the stabilizer and fin.
 - Sand and shape the rudder and elevator.

NOTE: Install hinges in the controls first. After they are set up, attach the controls to the tail surfaces. Read "INSTALLING EASY HINGES" mentioned earlier.

- 89.
- Put the wing on the fuselage and check to see if the stabilizer lines up with it when pinned in place on the fuselage. If it does not, sand one side or the other of the fuselage so that the stabilizer is level.
 - Glue the stabilizer to the fuselage. Use epoxy. To insure that the stabilizer is solidly glued to the fuselage, cut out the covering material in the area that contacts the fuselage to expose the bare wood. Puncture a series of 1/16" holes with a pointed wire in the stab and the fuselage top where they make contact. Have the holes at a slight angle to each other. When epoxy glue is worked into these holes and sets up it will act like small nails holding the parts together.

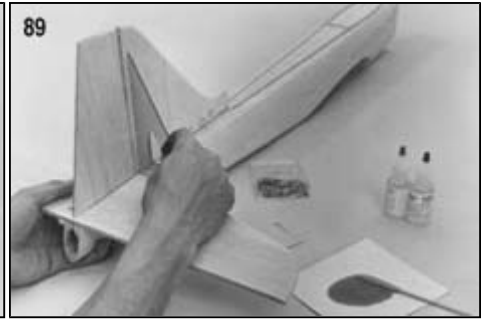
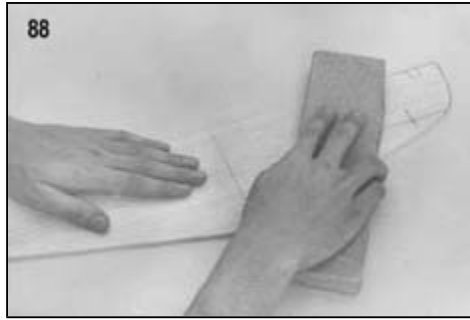
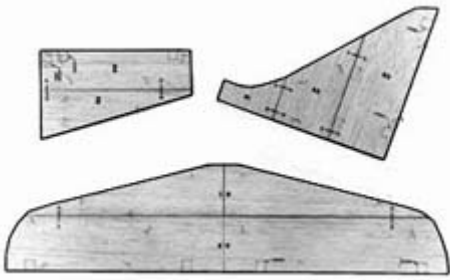

90. Shape the front of part FF so that the plastic turtle deck will fit over it.

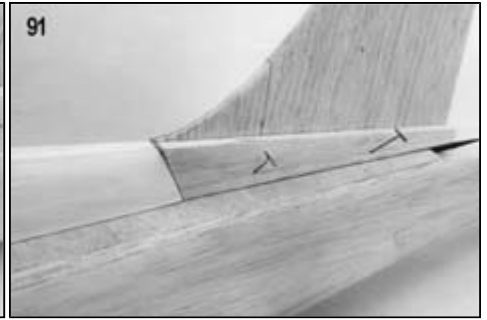
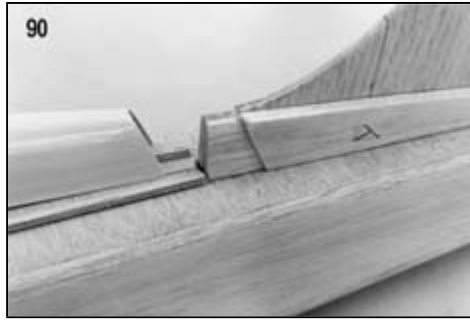

91. Pin FF in place and mark the contour on the front where it contacts the plastic turtle deck.

92. Carve and sand FF to a streamline shape.



93. a. Cut a 1/8" x 1-1/8" slot in the fuselage to pass the rudder pushrod.
b. The picture shows a Goldberg small pushrod exit guide being used to line the slot. However, the slot can be coated with epoxy glue to harden it and an exit guide will not be necessary.

94. The control horns should be installed before covering, then removed until the covering is completed. Models with silk and dope covering have a hard enough "shell" on the wood so that plywood reinforcement of the control horn area has not been found necessary. Other types of covering call for reinforcement by inserting a scrap plywood "scab" into the surface on the opposite side from the horn. This will keep the horn from pulling out of the wood when subjected to unusual strain.

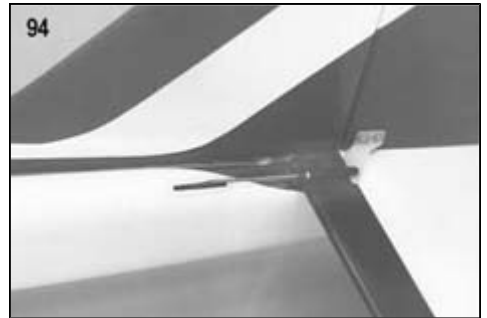

95. The elevator pushrod exits through the opening in the fuselage rear end. Take note that the elevator horn mounting holes are not centered on the elevator, but must be offset to the side slightly to have the horn arm in the center.

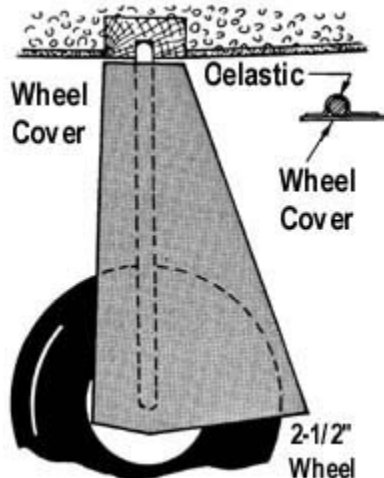
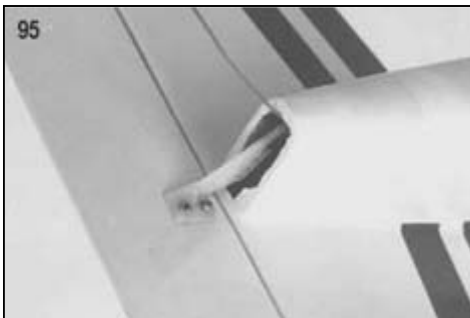

Cut the wheel cover from .030 ABS Sheet Plastic and glue to the landing gear with Celastic dipped in Acetone or Dope Thinner.

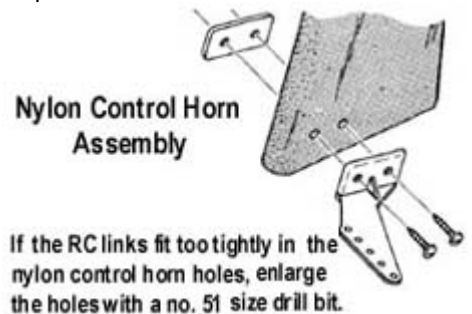

If the RC links fit too tightly in the nylon control horn holes, enlarge the holes with a no. 51 size drill bit.

COVERING AND FINISHING

IMPORTANT:

Don't skip covering the fuselage and tail just because they are solid wood. Painting them without covering first is not enough. They will be much more resistant to splitting and breaking on hard impacts if they are covered with something - Sig Silk, Silkspan, Sig Silray or iron-on covering material.

The manufacturer's directions for applying iron-on coverings are packed with the material. Follow these closely, for different types of covering have different iron-on temperatures and techniques of application.

Whatever kind of covering you desire to use, it will not conceal a rough framework. Sand carefully with fine sandpaper before beginning to cover.

Covering With Silk, Silkspan, or Silray

Although we refer to silk in the directions, all of these coverings are applied wet in the same manner as follows:

Brush an unthinned or very lightly thinned coat of clear Sig Supercoat or Sig Lite-Coat Dope over all parts of the framework that will contact the covering. When dry, resand with fine sandpaper, to remove any fuzz or raised grain. Brush on a second coat and sand again.

The bottom of the wing is a good place to start covering. Cut a piece of material about 1/2" larger all around than half of the wing, with the grain running lengthwise. (The grain of woven materials runs parallel to the finished bias edge.) Some builders next dip the piece in water and apply it to the wing. I find that the silk sticks together and takes a lot of pulling and smoothing to get it in place so we do it a bit differently as shown in the photo.

Pin the dry covering in place and "paint" the water on with a brush.

Go around the edges, pulling out wrinkles and stretching the material smooth. You need not pull it up drum tight, in fact going to this extreme is not advisable. Just pull out all of the wrinkles. Use pins, if necessary, to hold the silk smooth, though wet silk usually stays in place without too much pinning. We like to fasten one end - in this case the center joint of the wing - pretty firmly with pins so that you can pull against this anchored end in stretching the silk the long way.

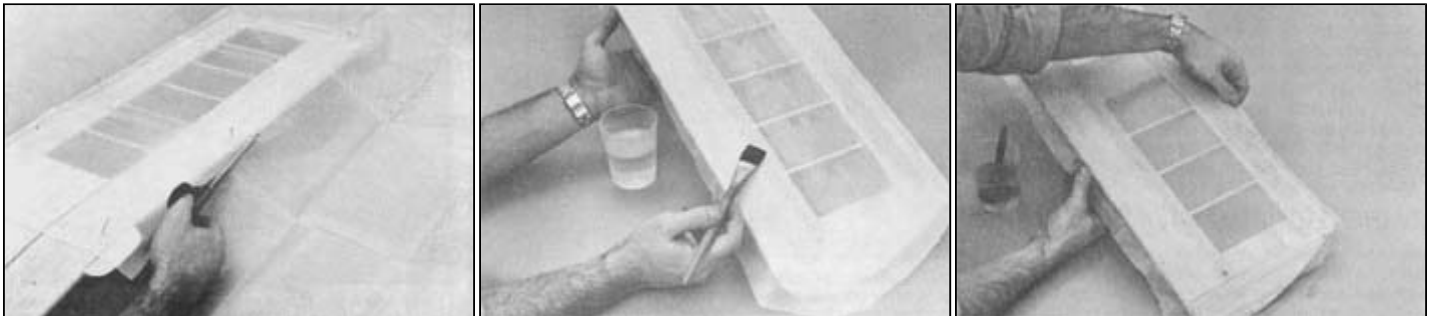

Brush around the outside edge of the stretched silk with clear dope. The dope will soak through the material and adhere to the dope already dried into the framework. Allow to dry.

Trim the edges with a sharp blade. We find that a thin double-edged razor blade is ideal for this, but a single-edged blade does okay and you can't cut your fingers on it. On the bottom, trim off flush with the wing all the way around. Go over any rough areas or places that have not stuck down properly with more dope and press the loose spots down as the dope is drying and getting stickier.

The top half is done in identical fashion except that the silk should be brought down over the edges instead of being trimmed off flush. On the front, lap the silk over the edge of the bottom, over-lapping about 1/8". At the back, bring the material down over the back edge of the trailing edge but do not lap it over the bottom covering.

Use the same process on the tail section and fuselage.



Allow the water to dry out of the wood before applying the first full coat of clear dope. Apply 3 or more coats of clear dope. Sand with 220 3M Tri-M-Ite or other no-load paper. Keep in mind that extra coats of dope will add weight. Sig Lite Coat clear dope may be used in place of Supercoat Clear if desired. It has low shrink characteristics and is less likely to warp.

Three coats of clear should provide a good base for color. Sand lightly when dry with 220 grit 3-M Tri-M-Ite no-load paper. The color dope may be brushed or sprayed.

Supercoat Color Dope should be thinned with 10% or more Supercoat Thinner for brushing. This helps prevent brush marks and gives smoother coats. Flow on wet coats and avoid rebrushing back over an area already painted. For spraying, thin dope about 50 - 50. Add more thinner if the dope does not go on evenly.

If high humidity causes the dope to "blush" or turn white, the test way to handle this problem is to wait until the humidity situation improves and apply another coat of dope. This will eliminate the blush. If it is necessary to dope during high humidity, Sig Retarder may be used in place of part of the Supercoat Thinner (amount depends on the humidity) to reduce the tendency to blush.

Painting the entire model white is recommended for a good color base, particularly when white is part of the color scheme. Color coats can be sanded with 360 Tri-M-Ite or 400 or finer wet paper. When using masking tape for trimming, seal the edge with a coat of clear dope to prevent the color dope from bleeding under the edge. Don't leave the masking tape on any longer than necessary. The longer it is on, the harder it sticks.

Complete the job with several sprayed coats of clear over the color scheme. This seals the colors and adds gloss. For best results, it is not a good idea to try to mix different brands of paint. Use SIG products from the start.

A CURE FOR FUSELAGE WARPING

You may have noticed when a piece of balsa is doped on one side and not the other, it will curl. The same thing can happen on the fuselage sides, under the wing opening, particularly when you put on a number of coats. (The rest of the fuselage will not show this effect to any extent because it is four sided and cannot distort.) The effect isn't noticeable until after full cure of the dope and aging, which may take several months. To prevent this from happening, give the inside fuselage a coat of dope every time you give the outside a coat. This has an added advantage in making the cabin area fuel proof. In addition, when the hardwood servo mounts are installed, have them a little over-long so that the cabin sides are bulged slightly outward.

Finishing The Plastic

The plastic parts should be sanded to remove the gloss before they are painted. Don't use coarse sandpaper, which can cut deep scratches. These scratches may open up during doping (which softens the plastic) and become more noticeable. Instead use something like 220 3-M Tri-M-Ite no load silicon paper to start and polish down with 360 Tri-M-Ite or 400 wet paper before color doping.

The plastic cowling and wheel covers may be painted with Sig Supercoat Dope. Care should be used not to apply heavy, wet coats of dope. Put on light coats and allow them to dry thoroughly before applying a second coat. A spray gun is a good method of getting a good finish with a minimum amount of dope. Be especially careful with spray cans not to wet the plastic too much. Spray several light dusting coats with adequate drying time allowed. Plastic may also be painted with Sig Plastinamel, Sig Skybrite, K&B Super Pox, Hobby epoxy or DuPont Dulux Enamel.

CANOPY: We recommend Sig Plastinamel or Sig Skybrite for painting the framing outlines on the canopy. Dope is very difficult to use on canopy plastic because of its warping action. Epoxy paint can be used, but it does not stick on the plastic quite as well as Plastinamel or Skybrite. Sanding the gloss off the plastic will help adhesion. Other enamels and plastic paints can be used, but test in advance on scrap. Glue the canopy on right after the paint is dry.

Decals

Decals are not furnished in the kit. See Sig catalog for special Kougars decals. The water-slide type will not adhere well to plastic film covering. For plastic-film covered Kougars, get Stik-Tite pressure sensitive decals. Stik-Tites can be used on any surface but are slightly thicker than water-slide decals

Stik-Tite	Water-Slide
<p>Cut out the decals with a pair of sharp scissors. Leave 1/32" to 1/16" of clear edge around the decal. Round corners when cutting. Wet the surface on which the decal will be placed with soapy water (dishwater detergent). Place the decal on the model and squeegee the water from underneath with a balsa paddle. Allow to dry. This procedure will prevent air from being trapped underneath as is possible when the decals are applied dry.</p>	<p>Dip the decals in water for a few seconds, remove and allow the moisture to soak into the backing to completely loosen the glue. Don't slide the decal off too soon, it may tear. Slide about 1/4" of decal at the bottom over the edge of the backing and align on the surface. Hold decal and carefully slide away the backing from underneath. Use a small paddle of 1/8" sheet balsa about 3/8" wide as a squeegee to remove excess water from under the decal. Hold down one edge with a similar paddle while squeegeeing to prevent the decal from being moved. Allow plenty of time for the glue under the decal to dry before wiping away the excess glue remaining on the surface of the model with a damp cloth. The decals are fuel-resistant with most fuels but will dissolve in dope or cement. Do not try to dope over decals. Some types of clear fuel proofer may be used over decals to increase durability but test them before applying. Leave about 1/16" of clear top coat around the decal stars when cutting them out of the sheet. Round corners to prevent tearing.</p>

96. Assemble the tank hardware as shown in the photo. Two vent pipes are used when your engine is equipped with a pressure tap. Run a line from one to the muffler tap. Put a piece of tubing on the other, running outside the cowl for filling. Pump fuel into this until it overflows into the muffler line. Then plug the filling hole with a 4-40 bolt. If pressure is not used, install only one vent. Fill by removing needle valve line, pumping into it until fuel runs out the vent. Bring it out the bottom of the cowl so raw fuel can't spray on the canopy. You can also use pressure on a single vent tank by filling through the needle valve line and letting the line to the muffler top be the overflow vent. See "TIPS ON TANKS" for more information.

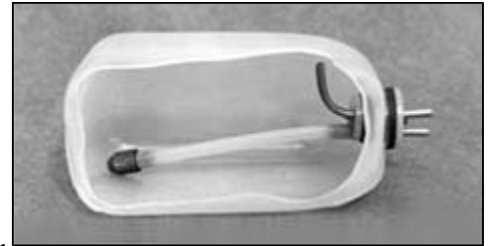

CUTTING HOLES IN THE COWL

These pictures show other cowlings but the same principles apply to the Kougarcowl.

Drill a series of holes, about 1/8" nearly touching each other. Cut through the wall remaining with a knife. A slit through the back behind the motor will aid removal. Cut the hole for the head with the carburetor off of the motor so it will be out of the way and then enlarge as required to pass the carb, needle valve, etc.

The best way to open up the hole is to go around the edges with an "applepeeling" motion, paring off a small amount of plastic with each stroke.

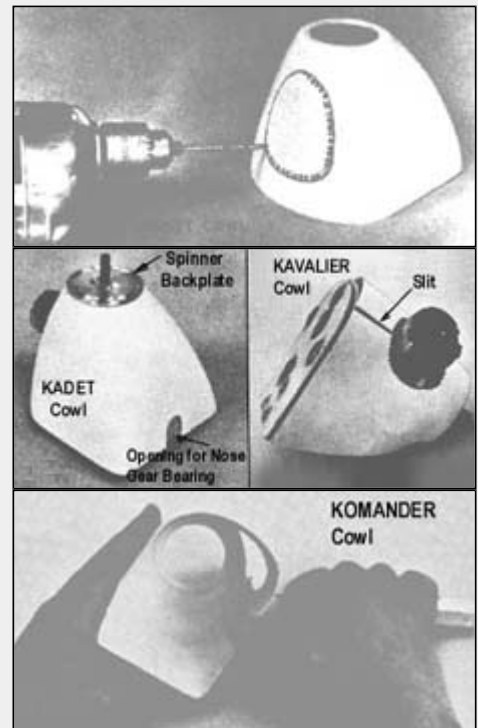

NOSE GEAR

- 97.
- The nose gear is held in the nylon bearing by the steering arm. Angle the arm forward so that when the servo pulls it back for a left turn, the arm will clear the face of the firewall.
 - A flexible steel cable pushrod with nylon outer tubing (not furnished) is recommended for the hookup of the nose gear, such as the SIGSH559 Flexible Cable Pushrod. Run the nylon outer tubing through the firewall at the right spot to connect the inner cable to the nylon steering arm. Epoxy around the tubing at the firewall so that no oil will leak into the fuselage.

Clevises

Clevises supplied in the kit may be metal or plastic. If the pins fit too tightly in the nylon horns, open up the hole with a No. 51 drill.

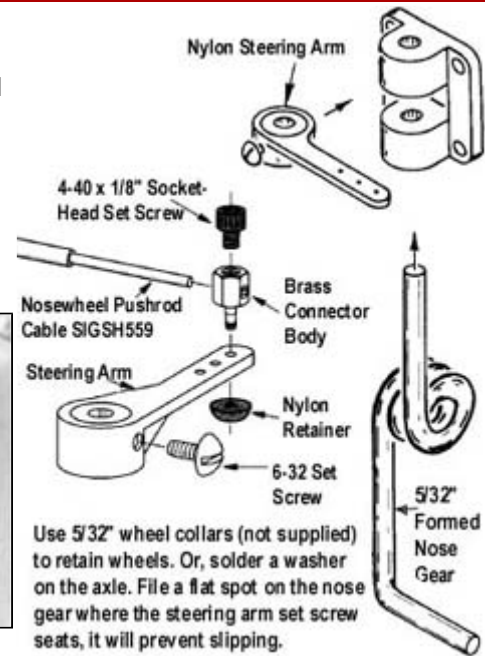

Servo Hook-Ups

Having the proper connector makes servo installation much easier. We show here a variety of ways to attach push rods to servos.

The Rocket City 07 Pushrod Retainer works okay for hooking the wooden push rods to the servo unless the movement or pushrod angle chosen makes it bump into the center post of the servo at the extreme end of the movement. (This can be fixed by changing the angle of approach to the servo or using a longer arm to bring the retainer out farther away from the center post of the servo.) This retainer is very easy to attach and detach.



Du Bro Ball Links, which come in several different types, threaded, bolt-on, rivet, etc., gets the push rod action up above the control arm so the pushrod can approach from a variety of angles without any chance of interfering with the servo center post. It is good for cable pushrods. A fine adjustment can be made by screwing the end in or out.



The SIGSH736 pushrod connector is handy for cable end attachment, as on the nosewheel steering arm, but can also be used on servos as shown. They are easily adjustable by loosening the screw and sliding the cable.

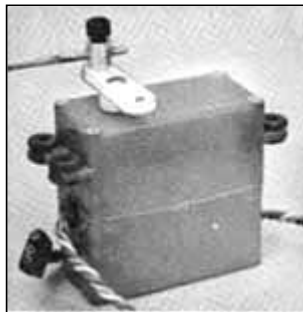

The SIGSH184 or Goldberg Snap'R Keeper can be installed on a wire push rod after it is bent, due to the design of the body of the fitting.



You should decide on which type of fittings you will use in the case of the cable pushrods and have them on hand during fitting construction because the type chosen will affect the location of the pushrod exit holes through the firewall, etc. The balsa pushrods to the rudder and elevator are not limited as to location and can be adapted to any of the types of connectors shown without preliminary planning of exact position.

Some of the variety of detachable pushrod retainers for securing the push rod wires to the servo that are available are shown here. Or you can make a "Z" bend in the end of the wires to go into the servo. When a "Z" bend is used, the pushrod must be put onto the servo outside of the fuselage and then threaded through the fuselage, which is more difficult to manage than the pushrod alone, as is the case when a retainer fitting is used.

5/16" square balsa sticks are provided to make the fuselage pushrods that run to the elevator and rudder. Bind the fittings to each end with heavy thread and epoxy glue. Use threaded rods with HC links at the tail end of the pushrods so that trimming adjustments can be quickly made. Straight pieces of 1/16" diameter wire are provided for the other end of the pushrods to allow hookup with the servo arm.

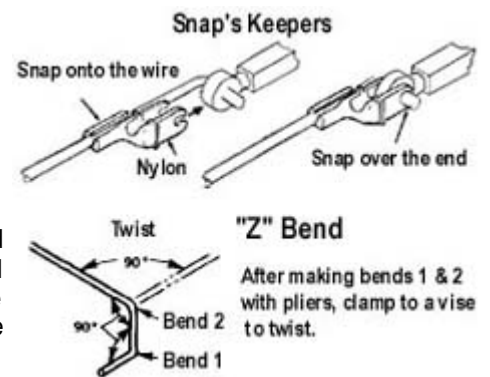

PREPARING CABLE PUSHRODS

To keep ends of cable from unraveling during handling, tin the end with solder. Use a non-corrosive paste flux (shown here is Kester, available at hardware stores) and rosin core solder. Have a hot iron and flow the solder completely through the cable.

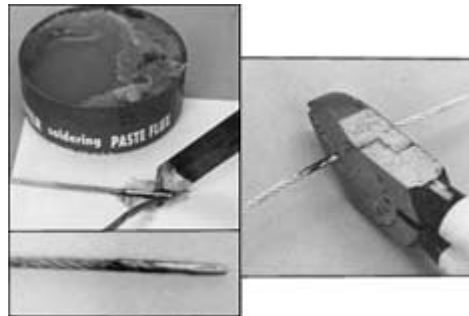

Grind or file the end smooth. Bring it to a point so that it will easily insert into the pushrod fittings.

After the proper length is arrived at, sweat solder the area to be cut so that it will not fray and unravel while being cut. It can be cut with a good pair of side-cutting pliers, filed in two, ground through on the edge of a grinding tool, or cut with a silicon cutting wheel on a motor tool.

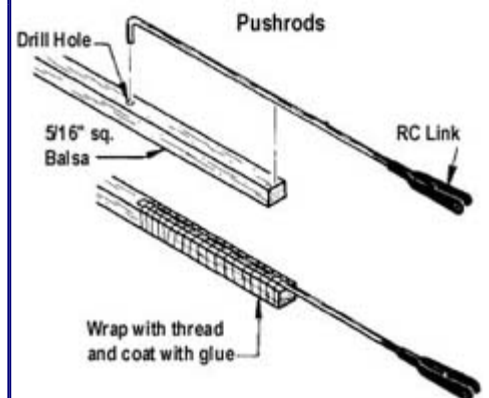

RADIO EQUIPMENT INSTALLATION

The most convenient method of installing servos is on the plastic mounts which most radio equipment makers offer with their outfits or as an accessory. These are screwed to hardwood mounting rails for fuselage servos or to hardwood blocks for mounting in the wings. Instructions for the use of these mounts are included with them.

A flexible cable pushrod with nylon outer tubing (not furnished) is recommended for hookup of the throttle to the motor control servo.

A variety of quickly detachable pushrod retainers are available from Sig Catalog for hooking the pushrods to the servos. SIGSH184 pushrod retainers are recommended, or a solder clevis (SIGSH527) may be used.

Servos, for which plastic mounts are not available can be screwed directly to the two 3/8" square hardwood rails placed across the cabin, three abreast, as shown in the accompanying drawing. With rubber grommets installed in the servo mounting holes, mark the spots for drilling the pilot holes for screws. Space the servos at least 1/8" apart and do not have them contacting the hardwood mounting rails except on the grommets. Using a washer on the wood screws, mount the servos to the rails. Do not tighten the screws down against the grommets since this will cause vibration to be transferred to the servos. The washer should just rest against the grommet without compressing.

The receiver battery pack should be wrapped in foam rubber sheet, held on with rubber bands. It is a good idea to put the package in a small plastic bag, taped shut around the battery cable to protect the battery from leakage.

The receiver should be similarly wrapped up in foam rubber to protect it from engine vibration. Cover it with a plastic bag also. Stow this package just in front of the servos. Make certain that the receiver will stay in place.

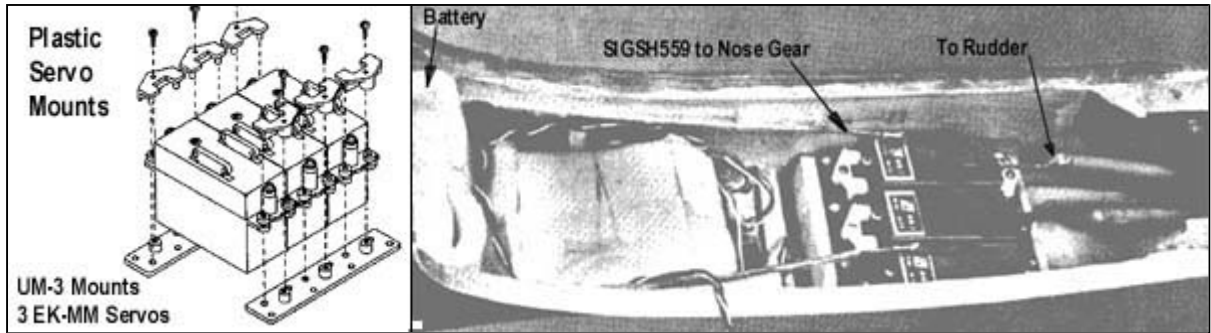

Radio installation in one of the prototype Kougars A UM-3 plastic mount on the 3/8" sq. crosspieces holds three EK-MM servos. The receiver is wrapped in a foam rubber package and stowed just ahead of the servos.

Some RC outfits have one or more reverse direction servos which are handy when it is found more convenient in a particular installation to have a pushrod hook to the servo on the opposite side.

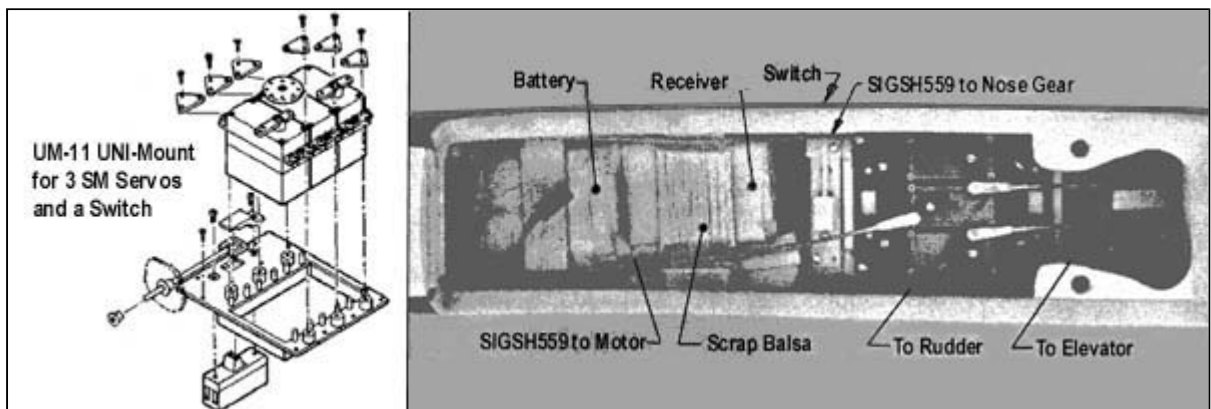

In this installation, using Logictrol SM servos, the battery and receiver have been semi-permanently installed. With scrap balsa crosspieces holding the foam rubber wrapped packages in place. The motor and nose wheel pushrods are tacked to the crosspiece over the receiver with 5-minute epoxy. If necessary to remove the equipment, break out the battery retaining cross-piece and pull out the battery and the receiver, leaving the receiver retaining strip in place. (Some Kougars may need the battery in the nose under the tank for proper balance.)

Control Movemants

Various brands of servos can give different control movement direction and amounts of travel. For this reason, follow the measurements below when setting the Kougars up for flight rather than any particular horn hole drawn in this book or visible in a Kougars picture. Shift the RC link to whatever horn hole will produce the amount of movement shown in the drawings below. Measurements are made at the trailing edge of the control surface.

The control measurements shown should give full aerobatic capability. Test flights may indicate a need for more or less movement, depending on individual model differences, C.G. location, your personal preferences, etc. (Flight Tests may determine that the neutral point should vary slightly from level but for purposes of illustration the neutral point is shown level.)

For training purposes, do not carry excessive elevator movement. Use only enough to properly perform a nice sized loop at full travel. Over control with excessive movement can get a novice in trouble. After you are more expert, additional movement can be used, if desired, for quick snaps and other violent maneuvers.

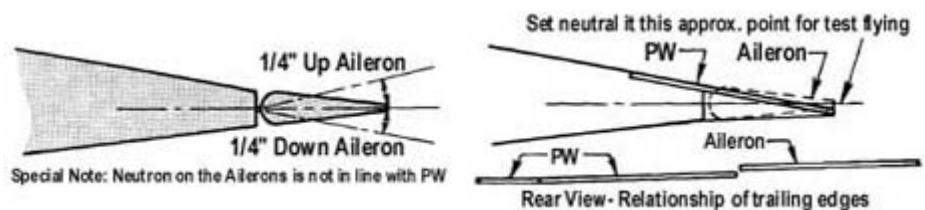

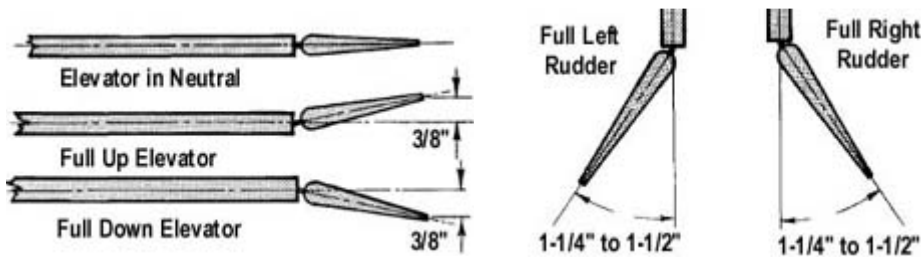

Balancing

The recommended Center of Gravity locations are:

- Test Fly with the balance point located anywhere between the leading edge at the wing tip and 1/2" back from the leading edge at the wing tip.
- Sport Fly at 1/2" back from the Leading Edge at the wing tip.
- Aerobatics - If your model will spin in both directions at 1/2" it need not be moved back any further. Some models need the balance point at 3/4" back for full response.

Flying with the balance point any farther back than 1" from the tip is not recommended unless you are an expert flier, with a purpose for doing so.

For the first test flight, balance the Kougur by suspending it on the finger tips placed on the bottom of the wing on the first mark. Balance with an empty fuel tank, but with all other equipment installed and the model completely finished and painted. Add lead to the nose, if necessary, to get the model to hang level. Be sure and fasten the weight securely. Do not attempt flight tail heavy.

The "Test Flying" position is on the nose heavy side. When slightly nose heavy, the model is more stable and less likely to stall or snap roll from over-elevating. It also cuts down reaction of the model to control movements and this is good during test and practice flights, to help prevent overcontrolling. After the model has been test flown and initial trimming accomplished you may want a little quicker response. Move the balance back slowly and check results in the air.

Some aerobatic capability is sacrificed with the forward C.G. positions, so for making deliberate snap rolls and spins a position farther back may be required. Move the C.G. back slowly and check results and control response in the air at a good altitude. Don't move the C.G. back any farther than necessary.

WHY MODELS MUST BE INDIVIDUALLY BALANCED

It is impossible to produce a kit that will automatically have the correct Center of Gravity (C.G.) position. Balsa wood varies in weight and it is easily possible for wood in the tail to be an ounce or more heavier or lighter than average. One ounce of extra weight in the tail has to be countered by about 3 ounces in the nose. Don't pile a lot of fillercoat or finish, use excess glue or make large fillets on the tail surfaces. The motor you choose, whether or not a muffler is fitted, the size and placement of your radio equipment, etc. all affect the balance. If you use an unusually heavy motor or muffler you may have to carry the battery in the radio compartment instead of the nose or even weight the tail. Don't consider that whatever C.G. the model builds out to as "good enough". Check carefully and make whatever adjustments that are required. With the C.G. properly located, a Sig design should fly with only minor trim changes required.

BALANCE IS PART OF THE TRIMMING PROCESS

The balance point we arrived at for this design is a good place to start when trimming out the model for top performance. However, it should not be considered the final and irrevocable location. Individual models built from the same kit are slightly different from each other. The incidence may be changed a bit, a small or large engine selected, the total weight varies - even the skill of the pilot has bearing on just what should be the exact C.G. point. For example, when slightly nose heavy, the model is more stable and less likely to stall or snap roll from over-elevating. This also cuts down the reaction of the model to control movements which is good during test and practice flights to help prevent overcontrolling. But later, if extra sensitivity and quick reactions are desired for aerobatic performance, a position farther back may be desirable. So try different positions, but make the changes gradually, checking results and the effect of the change control responses and the performance of the model in the air at a good altitude.

FLYING

IMPORTANT: The Kougar is not a basic trainer. If you have no previous RC flying experience you cannot successfully fly a fast and responsive design like the Kougar, particularly on test flights. It is suggested that you not attempt flying without the assistance of a modeler with experience. Contact your local model club or ask your hobby dealer for the names of good fliers in your vicinity and a suitable location for flying.

Many hours of work are involved in the construction of a model and it can all be lost in a moment of beginner's indecision. A skilled flier can help you get past the first critical test and trimming flights without damage to the model and give instruction in proper control.

Be certain to carefully range check your radio equipment and see how it operates with the engine running before attempting test flights.



A lot of problems can be avoided if the engine has been well broken-in and the idle adjustment perfected on a test block or in another airplane before installation in the model.



Takeoffs with the Kougar from grass fields are easily made if the grass is not too long or the ground too rough. Generally a lot of elevator application is required for liftoff.

Be prepared to relax control pressure partially after becoming airborne so the climbout will not be too steep. On surfaced or smooth dirt runways less application of elevator will be needed.

If a good, smooth take-off surface is not available, the model can be hand launched by the pilot's assistant. (Do not attempt to hand launch by yourself --- instant action on the transmitter may be required.) Holding the front part of the fuselage with the left hand and under the tail with the right, run into the wind at a fast trot and thrust the model forward with the nose slightly up in a spear throwing motion. It is not necessary to achieve a lot of velocity in the launch-it is more important that it be released smoothly and with the wings level. The model may dip slightly and then should begin climbing at a slight angle. If it does not begin to climb after about fifty feet of flight, apply a small amount of up to lift the nose. Use hand launching only as a last resort.

Use the ailerons to keep the wings level and headed straight into the wind until about seventy-five feet of altitude is obtained. Keep first turns gentle and not steeply banked. Stay up wind of the transmitter. Use trim levers on your radio equipment where necessary to obtain straight and level flight with the control sticks in neutral position but don't attempt to make these adjustments until the model is at a good altitude. Throttle back at altitude to find out the model characteristics in a gliding condition so that some indication is seen of what to expect during the landing approach. It is a good idea to make several practice landing approaches at a good altitude to get the feel of the model for this approaching critical maneuver. Make your final and complete landing approach while your engine still has plenty of fuel remaining so that the engine is not liable to stop before completion of the flight. This will allow application of power if the approach is undershot. Notice the percentage of missed landings at an R/C flying field. Those undershot greatly outnumber those missed by overshooting. So, if an approach that looks a little high is maintained, chances are good that a spotlanding can be made. After each test flight, readjust the RC clevis links on the pushrods so that the trim levers on the transmitter can be returned to a neutral position. It will take several flights before exact trim is established on all axis of flight.

Print, cut out and join the following pages together in order for the plans.

FUSELAGE SIDE VIEW HALF SIZE

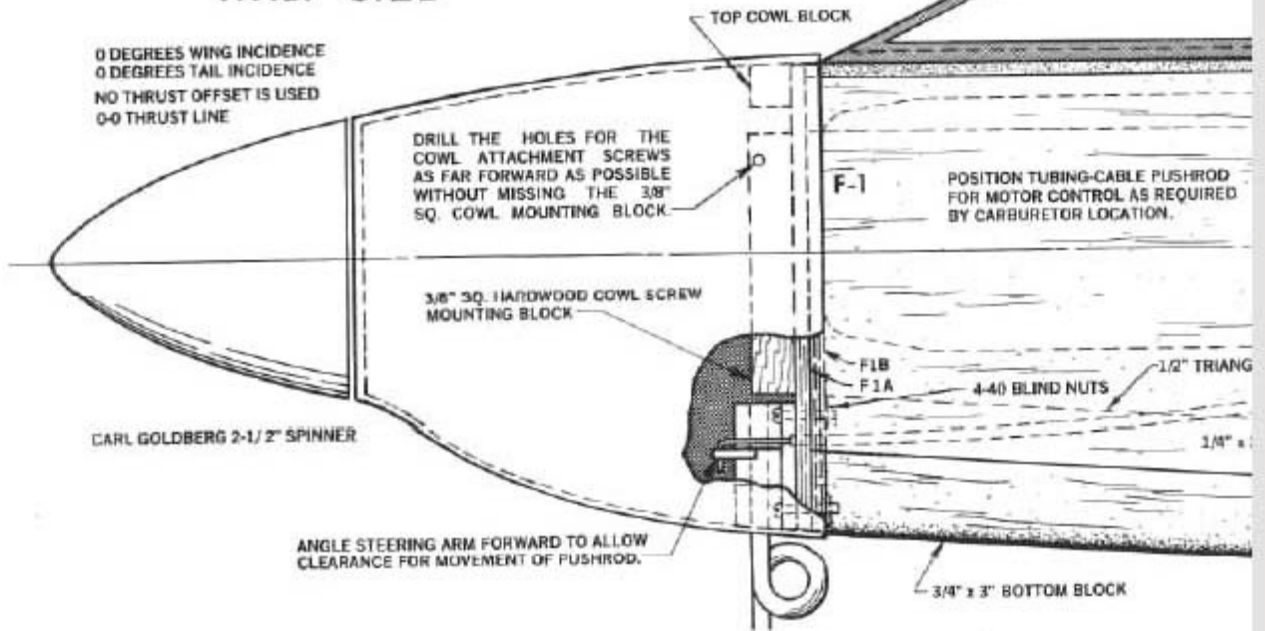

18

RECOMMENDED C.G. POSITION

READ "BALANCING" SECTION ON PAGE 33.

1/2" T

F2

REMOVE THIS SHEET FROM THE BOOK

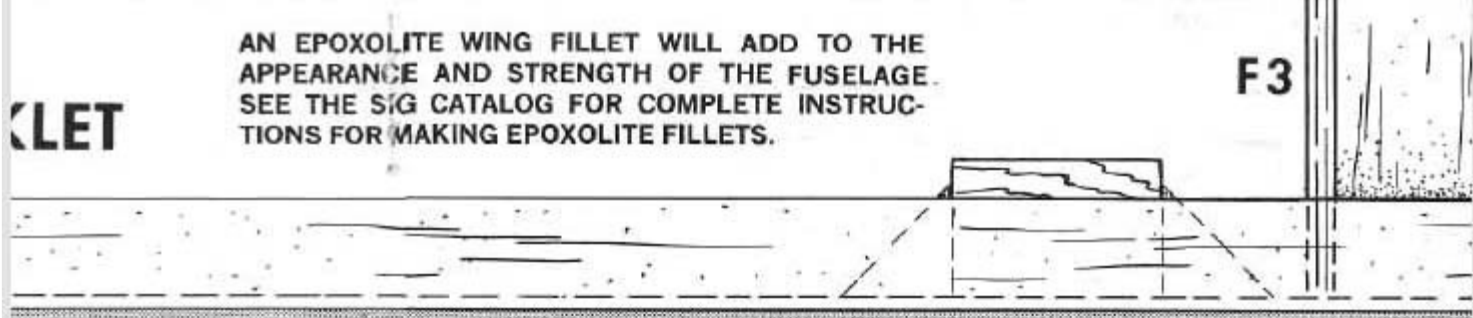
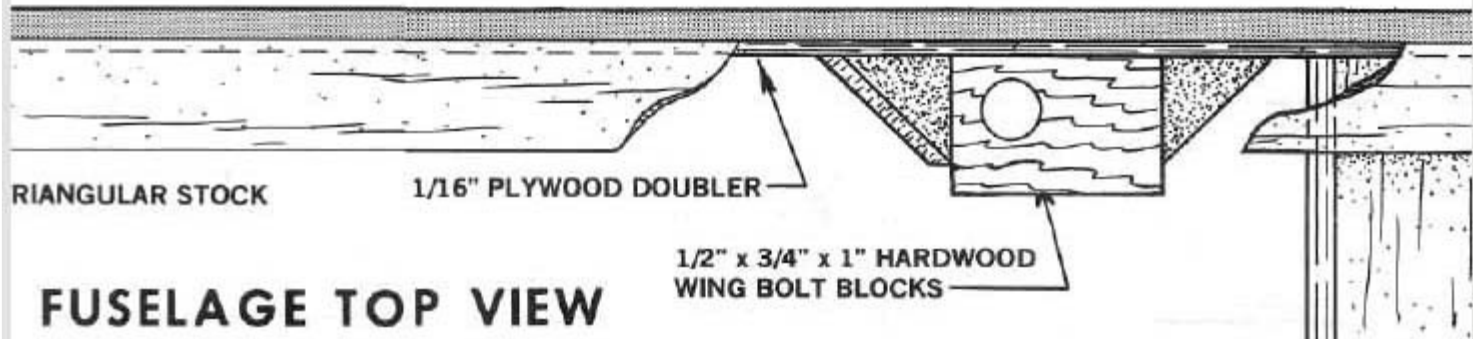
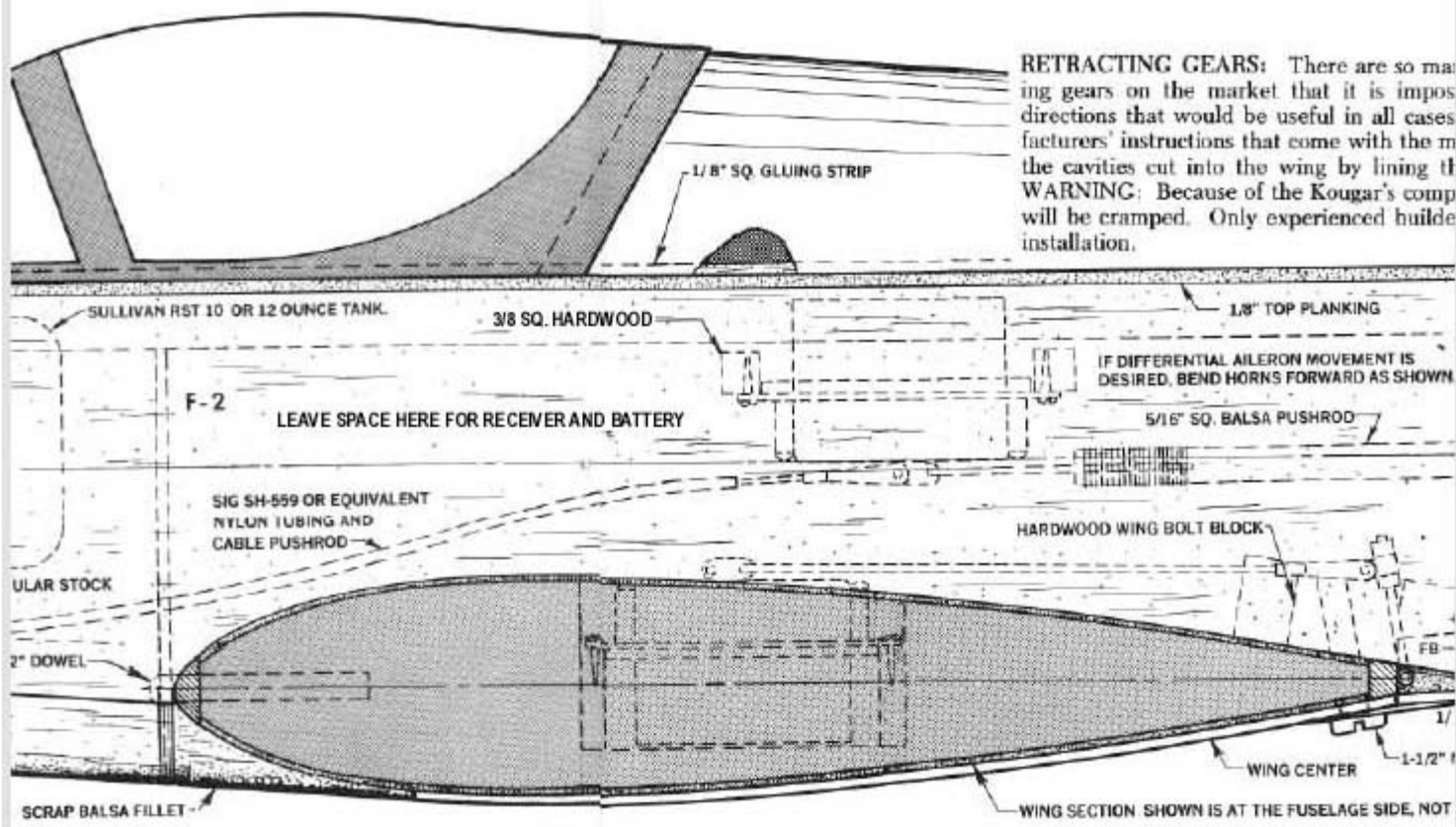

ny varieties of retract-
sible to give detailed
. Refer to the manu-
mechanisms. Reinforce
tem with sheet balsa.
act size, the nose gear
rs should attempt the

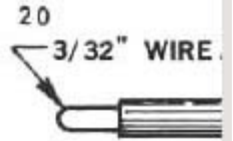
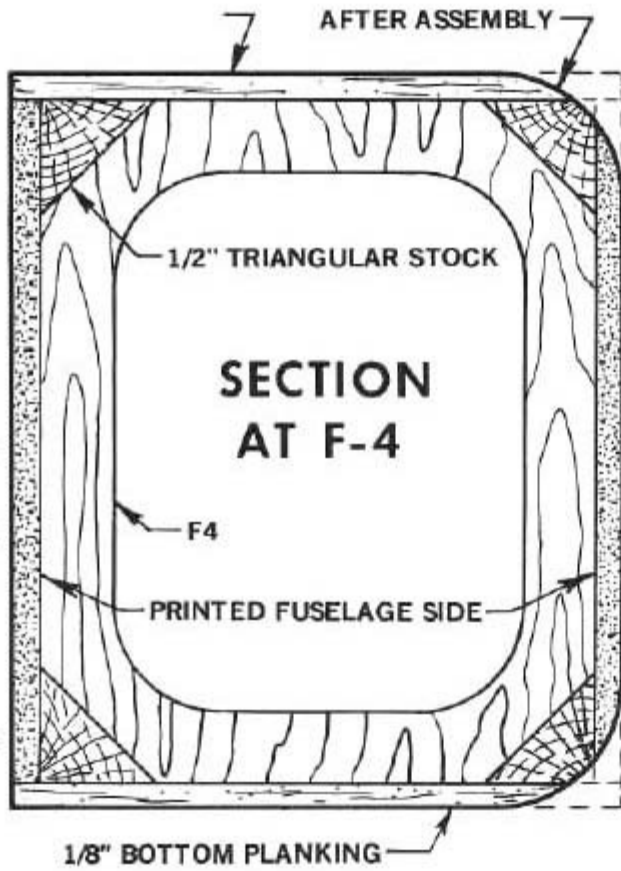
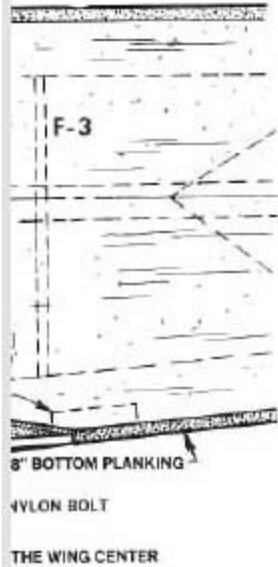

BRASS TUBIN

DIMENSIONS GIV
MATE AND MAY V
MODELS. CHECK
BEFORE FINAL CU

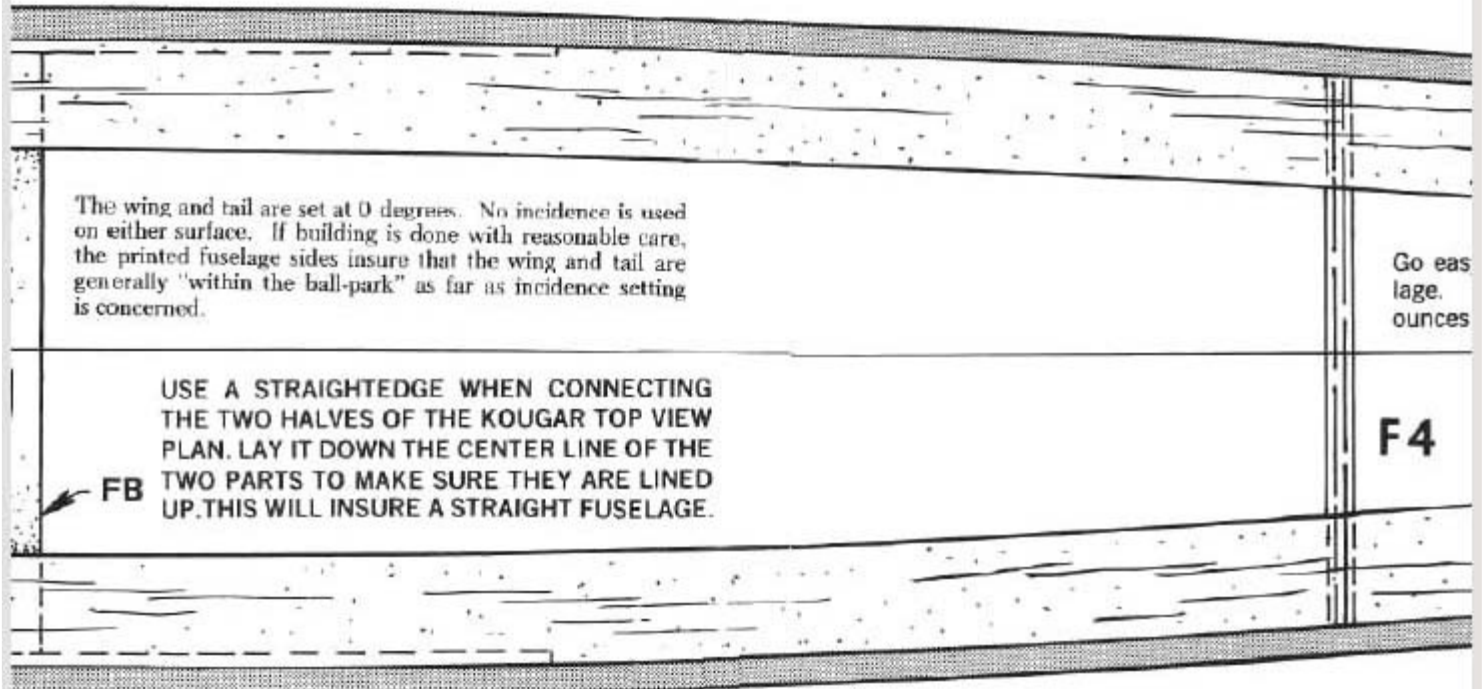

The wing and tail are set at 0 degrees. No incidence is used on either surface. If building is done with reasonable care, the printed fuselage sides insure that the wing and tail are generally "within the ball-park" as far as incidence setting is concerned.

Go eas
lage.
ounces

USE A STRAIGHTEDGE WHEN CONNECTING THE TWO HALVES OF THE KOUGAR TOP VIEW PLAN. LAY IT DOWN THE CENTER LINE OF THE TWO PARTS TO MAKE SURE THEY ARE LINED UP. THIS WILL INSURE A STRAIGHT FUSELAGE.

F4

EL FB TO FIT AGAINST TRIANGULAR STOCK.

AILERON HORN

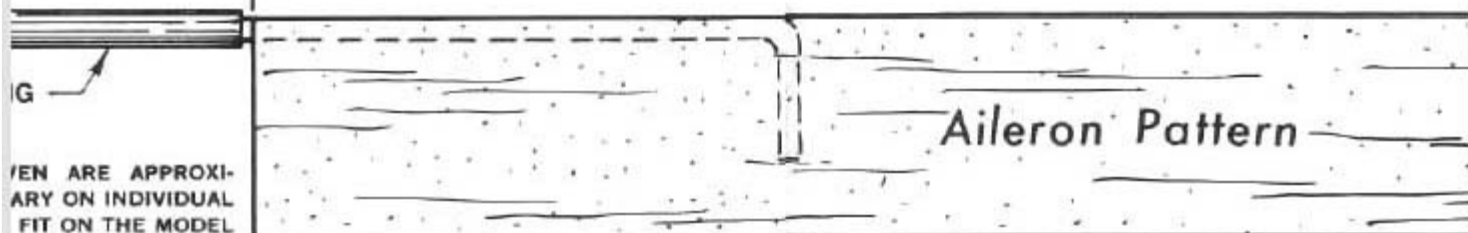

MEASUREMENTS ARE APPROXIMATE
ADJUSTMENTS ARE NECESSARY ON INDIVIDUAL
FIT ON THE MODEL
FITTING.

AILERONS ARE CUT FROM
1/4" x 1" SHAPED Balsa STOCK

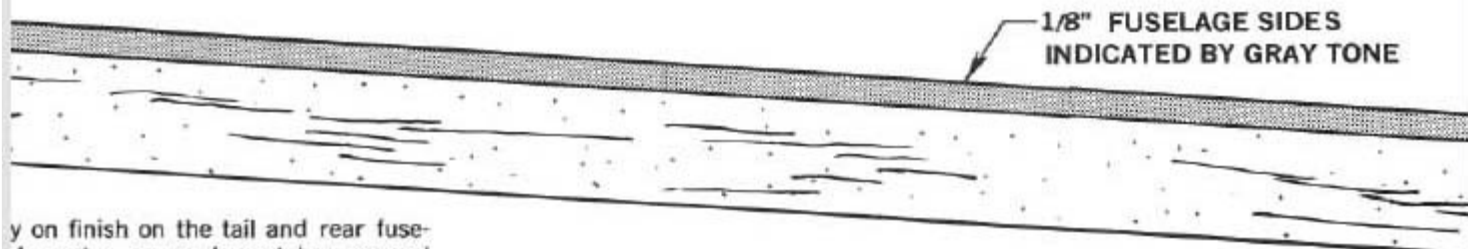

Finish on the tail and rear fuselage.
An extra ounce here takes several
on the nose to counterbalance.

FUSELAGE TOP VIEW

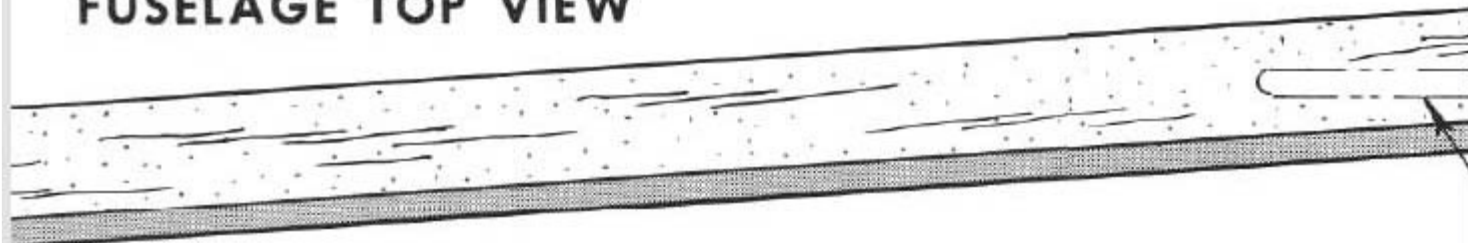

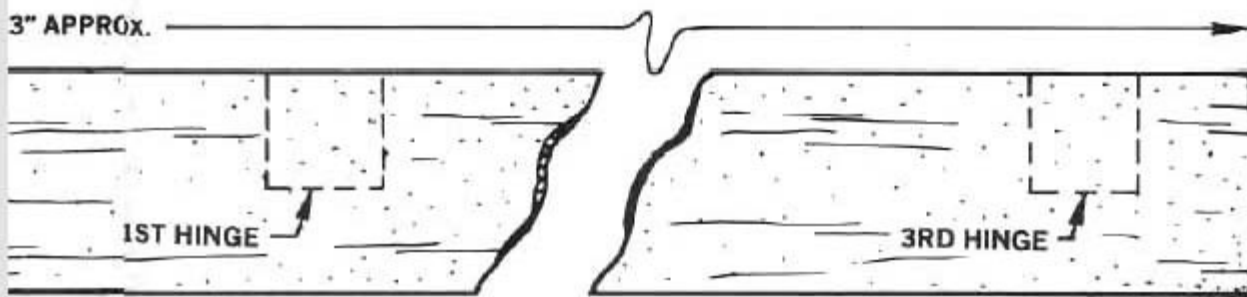

USE 3 HINGES. PLACE MIDDLE HINGE HALFWAY BETWEEN THE TWO OUTER HINGES.

LEAVE END OF FUSELAGE OPEN TO PASS ELEVATOR PUSHROD. PLACE ELEVATOR HORN SO IT WILL CENTER ON OPENING.

BEVEL TRIANGULAR STOCK TO FIT TOGETHER

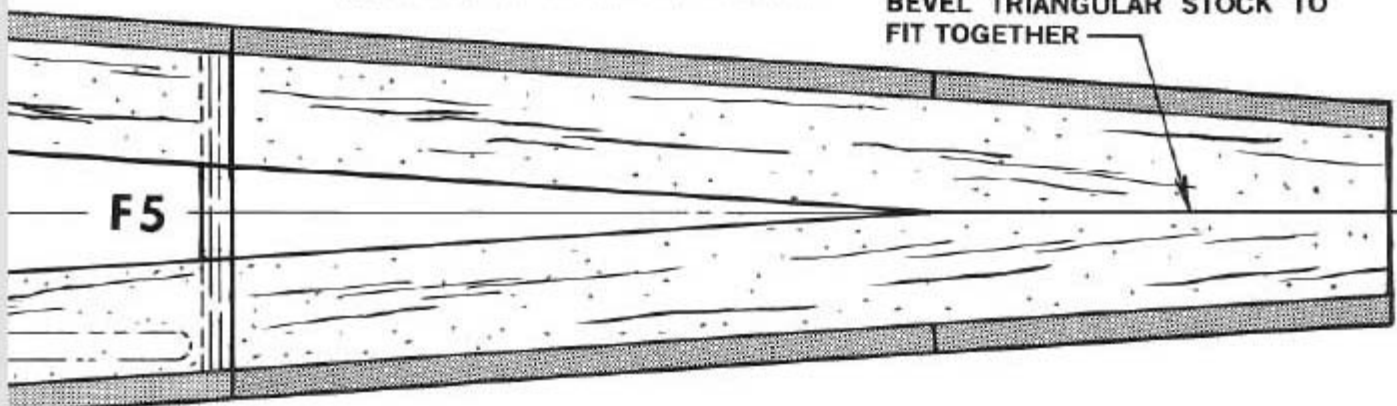

AFTER TOP PLANKING IS INSTALLED, CUT SLOT HERE FOR RUD-
DER PUSHROD EXIT.

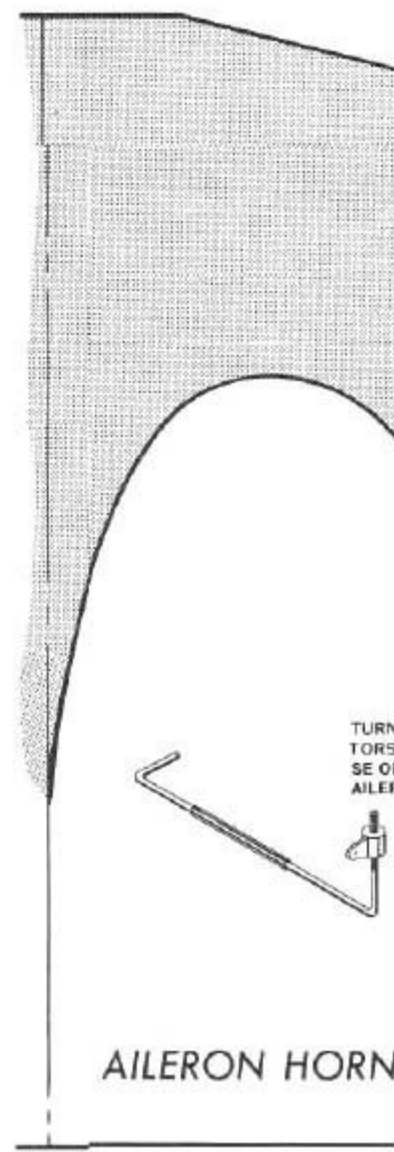
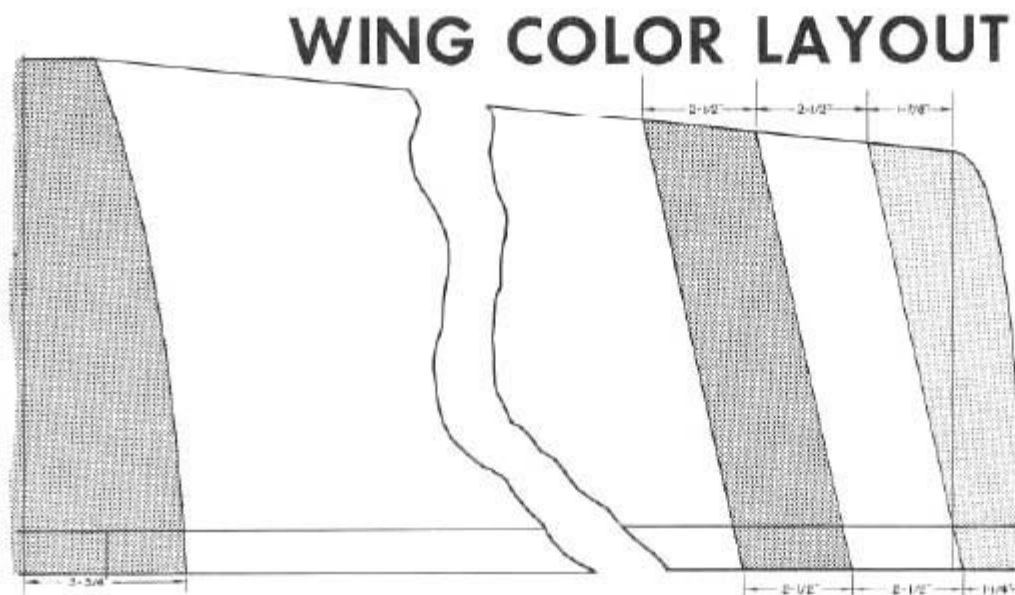
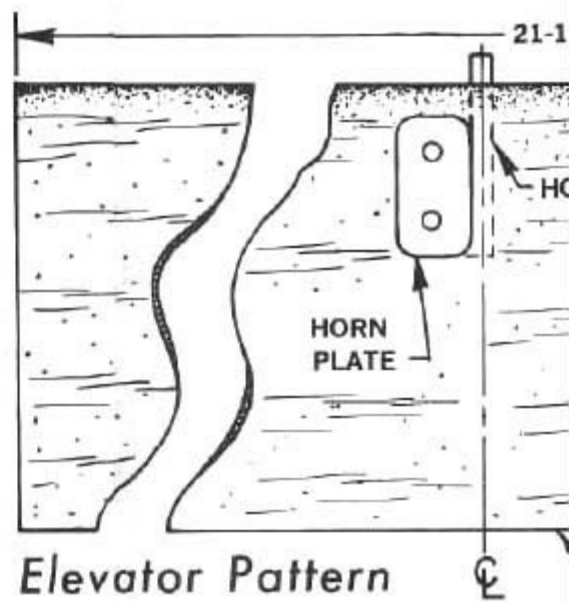
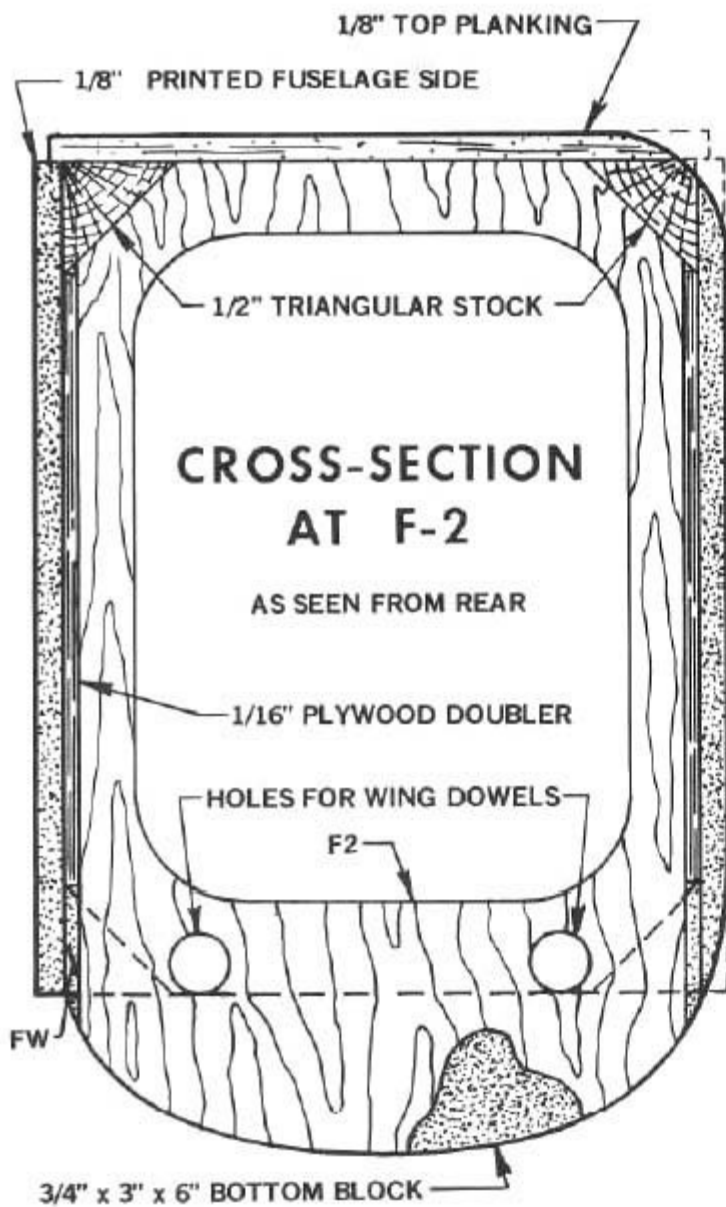

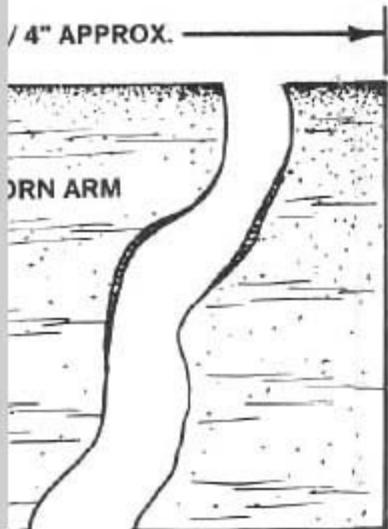

A WILLIAMS BROTHER'S 1-1/2" SCALE MILITARY PILOT FIGURE FITS THE KOUGAR. SOME BUILDERS LIKE THE LARGER 2" SCALE PILOT, BUT IT HAS TO BE SHORTENED.



TYPICAL FIN & STAB CROSS-SECTION

SELF-THREADING NYLON CONN. ONTO THE WIRE AILERON HORNS. RAISE OR LOWER THEM TO ADJUST AMOUNT OF AILERON MOVEMENT

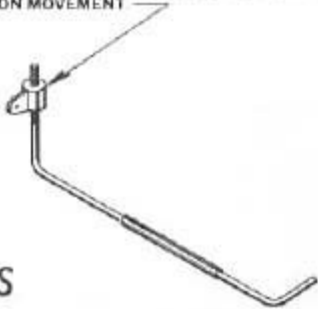

1/16" SCRAP PLYWOOD

STABILIZER PAINT PATTERN

CUT THE WHITE PORTION OF THIS PATTERN FROM ADHESIVE TAPE AND STICK TO THE STABILIZER FOR A SPRAYING OR PAINTING MEDIUM. USE THIN STRIPS TO OUTLINE THE WHITE PORTION LIGHTLY IN SOFT PENCIL AND USE THE THIN STRIPS TO OUTLINE THE WHITE PORTION. USE THICKER STRIPS TO FILL IN THE REMAINING AREA TO BE PAINTED.

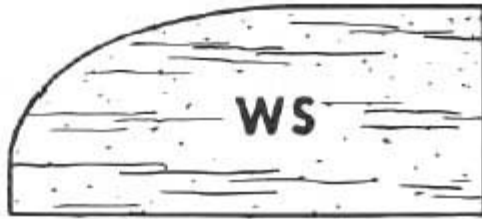

3/32" SCRAP BALSA

FIN PAINT PATTERN

SEE THE PHOTOS ON THE BOX LABEL AND COVER OF THE INSTRUCTION BOOKLET FOR LAYOUT OF THE FUSELAGE STRIPES. THIN STRIPS OF MASKING TAPE ARE HANDY FOR THIS, SINCE THEY CAN BE BENT EASILY AROUND CONTOURS.

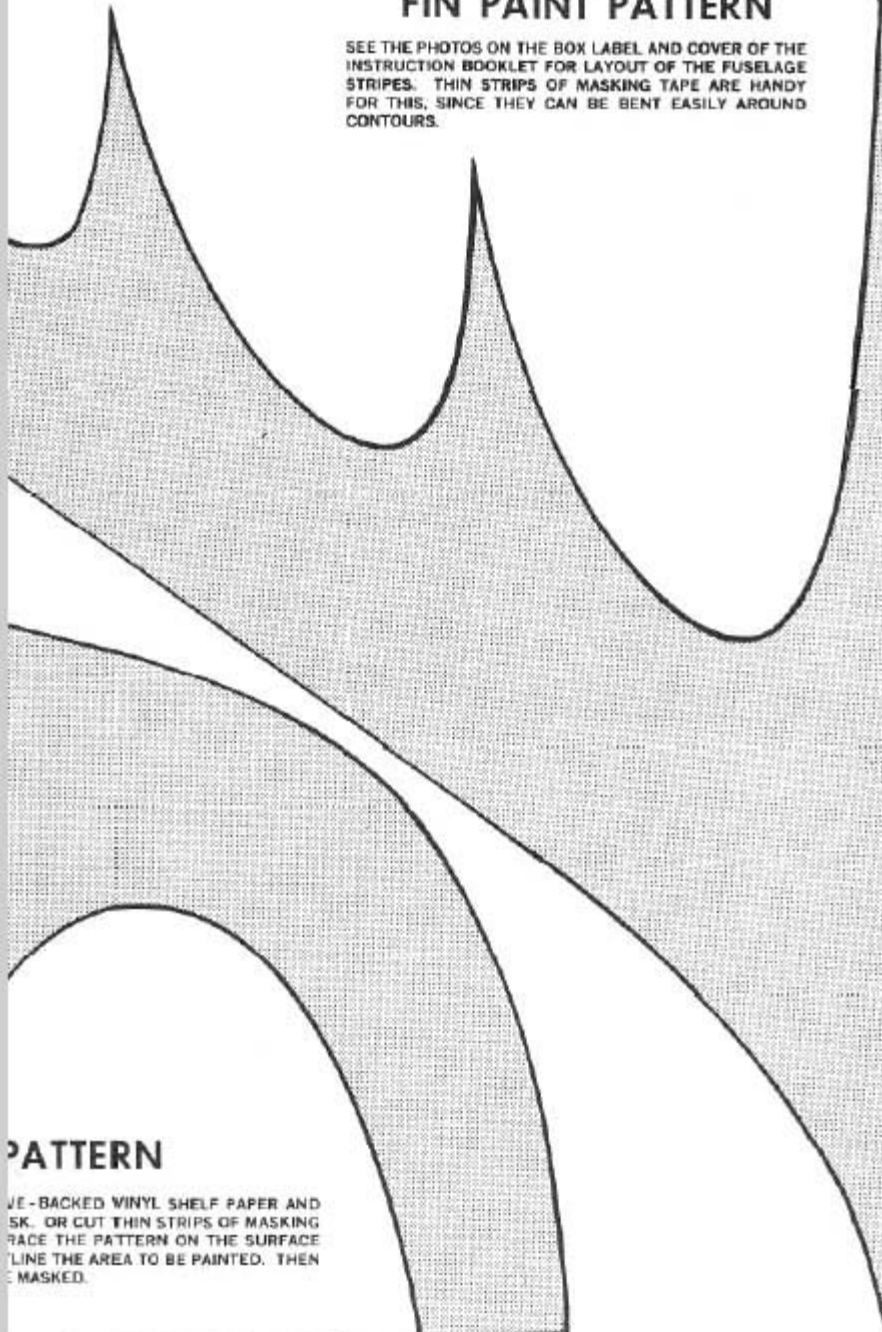

PATTERN

USE SHEET-BACKED VINYL SHELF PAPER AND MASKING TAPE. OR CUT THIN STRIPS OF MASKING TAPE. PLACE THE PATTERN ON THE SURFACE TO BE PAINTED. THEN MASK THE AREA TO BE PAINTED. THEN PAINT.

SIG MFG. CO., INC.

Montezuma, Iowa 50171-0520

LIMIT OF LIABILITY:

In use of our products, Sig Mfg. Co.'s only obligation shall be to replace such quantity of the product proven to be defective. User shall determine the suitability of the product for his or her intended use and shall assume all risk and liability in connection therewith.