

ASSEMBLY MANUAL



Kit No. SIGRC67EGVARF

KADET LT-40^{EG}

ALMOST READY TO FLY



Shown with optional Spinner
(not supplied)

DESIGNED FOR GLOW OR ELECTRIC POWER

Wing Span: 70 in. (1778 mm)
Wing Area: 900 sq.in. (58.1 dm²)
Length: 57 in. (1447 mm)
Flying Weight: 6 - 6.25 lbs. (2720-2835 g)
Wing Loading: 15-16 oz./sq.ft. (47-49 g/dm²)

Radio Required:

4-Channel with 5 Standard Servos (glow)
4-Channel with 4 Standard Servos (electric)

Glow Power:

2-Stroke .40-.46 cu.in. (6.5-7.5 cc)
4-Stroke .40-.54 cu.in. (6.5-8.8 cc)

Electric Power:

500-800 watt Brushless Motor (800-1000 kv);
50-75A Speed Control (ESC)
3S-4S 4000-5000 mah Lipo Battery Pack



GLOW



ELECTRIC

WARNING: Radio controlled model airplanes must be used responsibly! Just like a full-size airplane, they fly at a high rate of speed and are capable of causing serious bodily injury and property damage if they crash. IT IS YOUR RESPONSIBILITY AND YOURS ALONE TO:

- (1) Assemble this model airplane correctly according to the instructions.
- (2) To ground test the model before each flight to make sure it is completely airworthy.
- (3) To always fly your model in a safe approved location, away from populated areas.
- (4) To always fly your model in a safe manner. Your first test flights should be made with the assistance of an experienced R/C flyer.

LIMIT OF LIABILITY: SIG Mfg. Co., Inc. guarantees this kit to be free from defects in material and workmanship at the date of purchase. The actions, skills, and attention to detail of the modeler in assembling and flying this model airplane will ultimately determine its success and safety. Sig Mfg. Co.'s only obligation shall be to replace those parts of the kit proven to be defective or missing. The user shall determine the suitability of the product for his or her intended use and shall assume all risk and liability in connection therewith.

SIG MFG. CO., INC. PO Box 520 Montezuma, IA 50171-0520
www.sigmfg.com

© Copyright 2014, SIG Mfg. Co., Inc.

SIG *ALMOST READY TO FLY*
KADET LT-40 



Kit No. SIGRC67EGVARF

ASSEMBLY MANUAL

INTRODUCTION

Welcome to the sport of radio control flying, and thank you for choosing the SIG KADET LT-40 EG ARF. In order for your KADET to fly as well as it was designed to, it must be properly assembled. Work slowly and follow the instructions exactly. This kit features a proven aerodynamic design, quality materials, and detailed instructions, but ultimately the flyability of your finished model depends on how well YOU put it all together.

The KADET LT-40 has earned a reputation as one of the very best R/C trainers in the world. Tens of thousands of newcomers have successfully learned to fly R/C with a KADET LT-40. This ARF version of the LT-40 gets you into the air quickly. It is designed to fly with either a .40-.46 2-stroke glow engine, a .40-.54 4-stroke glow engine, or a 500-800 watt electric motor.

CUSTOMER SERVICE

SIG Mfg. Co., Inc. is committed to your success in building and flying the KADET LT-40 EG ARF. Should you encounter any problems, or find any missing or damaged parts, feel free to contact us by mail or telephone.

SIG MFG. CO., INC.
P.O. Box 520
Montezuma, IA 50171-0520

Telephone: 1-641-623-5154

Internet: **WEB SITE: www.sigmf.com**
E-MAIL: mail@sigmf.com

READ ALL INSTRUCTIONS CAREFULLY

We urge you to read this assembly manual completely before assembly. Familiarize yourself with the parts and their assembly sequences. The successful assembly and flying of this airplane is your responsibility. If you deviate from these instructions, you may wind-up with problems later on.

If this is your first R/C Aircraft PLEASE READ THIS!

As already mentioned, the KADET LT-40 EG ARF is a perfect model for learning to fly R/C. However, it is important to understand that if you have never flown an R/C model before, you will need to find a qualified R/C flight instructor to test fly the airplane and teach you how to fly it. If this is your first radio control model airplane, **DO NOT** attempt to fly it by yourself without a qualified instructor.

ARE YOU INSURED?

The governing body for radio-control model airplanes in the United States is the ACADEMY OF MODEL AERONAUTICS, sometimes referred to as the AMA. While AMA membership is

not mandatory, it is a good idea and we encourage all new R/C fliers to join the AMA. Membership in the AMA provides you with important liability insurance protection in case your R/C model should ever cause serious property damage or personal injury to someone else. Because of that liability protection, most R/C clubs require AMA membership before you can fly at their field.

Join the AMA for the welfare of the hobby!



ACADEMY OF MODEL AERONAUTICS

SINCE 1936

For more information
 ACADEMY OF MODEL AERONAUTICS
 5161 East Memorial Drive
 Muncie, IN 47302
 Ph: (765) 287-1256
www.modelaircraft.org

ADDITIONAL ITEMS YOU WILL NEED TO PURCHASE

In addition to this kit, you will need the following items to complete your KADET LT-40 and make it flyable.

RADIO SYSTEM

The KADET LT-40 EG ARF requires a standard 4-channel radio system and four "standard" size servos (50-70 oz. torque). We recommend that you buy a radio system with rechargeable batteries and a battery charger.

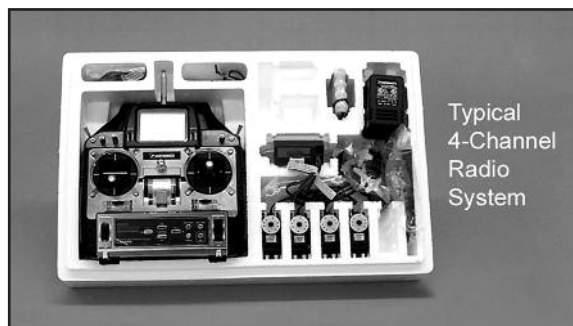

Typical
 4-Channel
 Radio
 System

For this installation you will also need **(2) 6-9 in. long servo extension chords**; and **(1) servo Y-harness chord**. These items are needed to complete the hookup of the aileron servos in the wings to the receiver in the fuselage.

POWER SYSTEM - GLOW OR ELECTRIC?

The biggest decision you will have to make is whether to power your KADET LT-40 with a glow engine (2-stroke or 4-stroke) or an electric motor. We have flown the KADET LT-40 on a variety of both types of power systems, and we make the following recommendations based on our successful on-field experience.

GLOW POWER RECOMMENDATIONS

ENGINE

We recommend the following size for the KADET LT-40 EG.

2-STROKE - .40 to .46 cu.in.

4-STROKE - .40 to .54 cu.in.

Don't let the large size of the KADET LT-40 fool you! Due to its huge wing area, very light wing loading and slow flight envelope, these engines will provide ideal power for training or general sport flying the KADET LT-40.

Whatever brand glow engine you choose, take the time to carefully break it in according to the manufacturer's instructions.

A good running, reliable engine is a minimum requirement for the enjoyment of this or any R/C model aircraft.

□ PROPELLER FOR GLOW

Refer to the engine manufacturer's instructions for recommendations on proper propeller size for their engine. In our experience, most 2-stroke .40-.46 glow engines will fly the KADET LT-40 very nicely with a 10x6 or 11-6 prop.

ELECTRIC POWER RECOMMENDATIONS

□ 500 - 800 watt BRUSHLESS OUTRUNNER MOTOR

The KADET LT-40 will fly well with a 500 to 800 watt electric brushless outrunner motor. This size motor is sometimes referred to as a "32" or "40" class motor to those who like to make a comparison to a glow motor. Also, the motor you choose should be rated at 800-1000 kv, in order to turn an appropriate propeller.

These motor sizes have worked well in the KADET LT-40:

3528-1000
4220-770
4248-800
4250-800

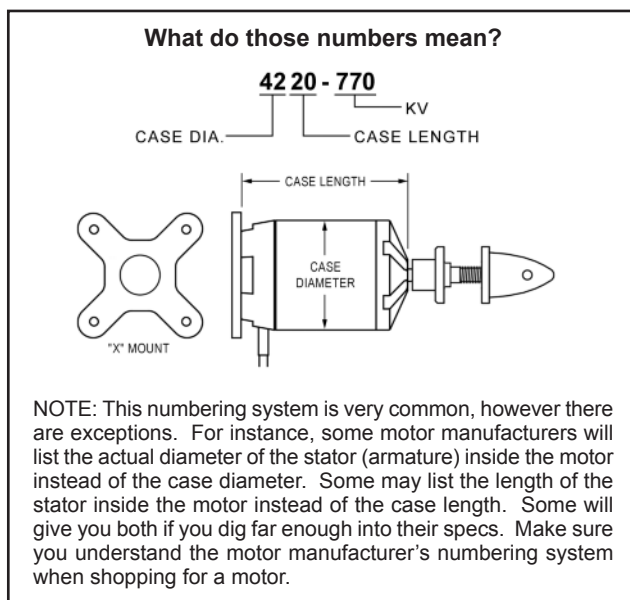

□ MOTOR MOUNT

A laser-cut plywood adjustable motor mount is included in this kit. It should work perfectly for any suitable brushless outrunner motor which has an "X" or "cross" motor mount plate on the back.

□ 50-75 amp ESC (Electronic Speed Control)

The amp rating of your ESC will depend on your choice of motor. Be sure to follow the motor manufacturer's recommendation.

We used a Castle Creations brand ESC. This is an excellent "switching type" ESC that has a built-in 5amp BEC that is safe to use with a 3 or 4 cell lipo battery pack. We typically see amp draw of 30 to 48 amps, depending on whether a 3 cell or 4 cell lipo is being used and the propeller size.

NOTE: The Castle Creations ESC that we used, as well as the many of the other ESCs on the market, has a BEC (Battery Eliminator Circuit) built in. BEC allows you to use the same battery pack to power both your motor and your radio system, eliminating the normal radio battery pack. When the single battery pack runs down in flight to a prescribed point, the BEC circuit in the ESC will shut down the motor and leave enough power to operate the radio while you land the model.

Note that the BEC feature in some ESCs does not work with 4 cell and larger lipo battery packs - only 3 cell packs. Check the manual of your particular ESC to learn if this is true in your case. If your BEC is only rated for 3 cells, you have three options: 1) fly only 3 cell lipo packs (and have lower power); or 2) disable the BEC and install a separate receiver battery pack to run the radio and servos full time; or 3) install an aftermarket BEC that is properly rated for your setup.

We wanted to be able to fly both 3 cell and 4 cell packs interchangeably, so we elected to use a separate receiver battery pack, since we already had it and the little bit of extra weight is no problem for the KADET LT-40. We then disabled the BEC feature of our Castle ESC, since we no longer needed BEC. Disabling the BEC allows the speed control to be used with both 3 cell and 4 cell packs without problems. A common way to disable BEC in many ESCs is to remove or clip the middle wire from the plug on the ESC that goes into the radio receiver - see your ESC manual for more guidance.

□ 3 or 4 cell 4000-5000 mAh LIPO BATTERY PACK

The KADET LT-40 will typically use a 3 cell (3S1P) 4500mAh or 4 cell (4S1P) 4500mAh Li-po pack. Again this will depend on your choice of motor. Be sure to follow the motor manufacturer's specifications.

□ PROPELLER

With electric powered models there are many factors that have a bearing on what propeller to use. The best place to start answering that question is in the instructions that come with your motor. Another fine source of information is one of the electric flight calculators that are available for you to use free online (there is a good one on Castle Creations web site).

CAUTION: You must match your propeller size to the cell count of your lipo pack, to avoid drawing too many amps and damaging your ESC or motor.

□ OUR FLIGHT TEST REPORT

The airplane illustrated in this manual used a Maxx Products HC3528-1000 Brushless Outrunner Motor, with a 50 amp Castle Creations ESC, and an APC 11x7 E propeller. This combination gave excellent flight performance. With this motor we were able to use either a 3 cell (3S1P) 4500mAh or a 4 cell (4S1P) 4500mAh Li-po pack interchangeably.

With a 3-cell (3S1P) 11.1v lipo pack, we recommend an APC 11x7E, APC 11x8E, or APC 12x6E propeller for the Maxx Products HC3528-1000 motor. All three sizes delivered good performance, very reminiscent of flying an LT-40 with a 2-stroke .40 glow engine. For a starting prop we recommend the APC 11x7E. Other brand propellers of same size and similar design can also be used.

With a 4-cell (4S1P) 14.8v lipo pack, we recommend an APC 10x7E, APC 11x5.5E, or APC 11x7E propeller for the Maxx Products HC3528-1000 motor. All three sizes delivered good performance, very reminiscent of a 2-stroke .46 glow engine. For a starting prop we recommend the APC 10x7E or 11x7E.

□ BATTERY CHARGER

FOR SAFETY AS WELL AS PERFORMANCE, CHARGE LIPO BATTERIES ONLY WITH A LIPO BATTERY CHARGER!

In addition to providing the critical charging profile needed to safely charge lipo batteries, a lipo battery charger also includes the capability of "balancing" the available voltage in the cells, ensuring that the battery pack is at peak capacity at the end of the charge cycle. This translates to better flight times and a longer life from the battery pack.

REQUIRED TOOLS & BUILDING SUPPLIES

For proper assembly, we suggest you have the following tools and materials available:

A selection of glues - SIG Thin & Medium CA Glue,
CA Accelerator, CA Debonder,
SIG Kwik-Set 5-Minute Epoxy

Assorted Screwdrivers
Pliers - Needle Nose & Flat Nose
Diagonal Wire Cutters
Small Allen Wrench Assortment
Pin Vise for Small Dia. Drill Bits
Hobby Knife with sharp #11 Blades
Small Power Drill With Selection of Bits
Dremel® Tool With Selection of Sanding & Grinding Bits
Scissors
Sandpaper (such as 80 or 100 grit)
Heat Iron & Trim Seal Tool
T-Pins (such as SIG #SH-307)
Masking Tape
Soft Pencil or Fine Point Felt Tip Pen
Ruler and/or Tape Measure
90° Triangle (such as SIG #TR-036 Metal Triangle)
Alcohol or Acetone For Epoxy Clean-up

1/2" Thick Soft Foam Rubber (such as SIG #RF-240) - Used to protect your radio receiver and battery from vibration. Can also be used as packing around radio components or the fuel tank to keep them from shifting around in flight.

COMPLETE KIT PARTS LIST

The following is a complete list of all parts contained in this kit. Before beginning assembly, we suggest that you take the time to inventory the parts in your kit. Use the check-off boxes provided in front of each part description.

- (1) Fuselage & Hatch
- (1) Right Wing Panel & Aileron, hinges installed (not glued)
- (1) Left Wing Panel & Aileron, hinges installed (not glued)
- (1) Stabilizer & Elevator, hinges installed (not glued)
- (1) Fin & Rudder, hinges installed but (not glued)
- (1) Fiberglass Cowling
- (1) Aluminum Tube Wing Joiner

- (3) 3" dia. Wheels
- (2) Formed Main Landing Gear Wires
- (2) Nylon Landing Gear Straps, for main gear wires
- (4) M3 x 15mm Screws; for landing gear straps
- (1) Formed Nose Gear Wire
- (1) Nose Wheel Steering Arm with Set Screw
- (6) Wheels Collars; for main gear(4) and nose gear(2)
- (1) Fuel Tank Body
- (1) Rubber Stopper Assembly, for fuel tank
- (1) Fuel Pick-Up Weight, for fuel tank
- (1) Fuel Line Tubing, for fuel tank
- (1) Plywood Fuel Tank Support
- (1) Balsa Block; for fuel tank stop block
- (2) Glow Engine Mounts; for glow engines
- (4) M4 x 25mm Slotted-Head Bolts, for glow engine mounts
- (4) M4 x 30mm Slotted-Head Bolts, for glow engine
- (4) M4 Lock Nuts, for glow engine
- (1) Plywood Electric Motor Mount Box
- (1) Balsa Triangle Stock
- (8) M4 x 16mm Socket-Head Bolts; for electric motor
- (4) M4 Split-Ring Lock Washers; for electric motor
- (4) M4 Blind Nuts; for electric motor
- (16) M4 Flat Metal Washers
- (2) 35-1/2" long Pushrod Wires w/ Hex Nut; for elev. & rud.
- (2) 7-1/8" long Pushrod Wires w/ Hex Nut; for ailerons
- (1) 19-3/4" long Pushrod Wire w/ Z-bend; for nose gear
- (1) 19-3/4" long Pushrod Wire; for throttle
- (1) 13-3/4" long Nylon Pushrod Tube, for throttle
- (4) Metal Clevis; for ailerons(2), elevator(1), rudder(1)
- (4) Short pieces of Fuel Tubing; for clevis keepers
- (4) Pushrod Snap Keepers; for ail(2), elev(1), rud(1)
- (2) Metal Pushrod Connectors; for throttle & nose gear
- (1) Nylon Clevis; for throttle
- (4) Nylon Control Horns; for ail(2), ele(1), rud(1)
- (12) M2 x 15mm Screws; for control horns
- (4) M3 x 10mm Sheet Metal Screws; for cowling
- (2) M6.5 x 45 mm Nylon Wing Bolts
- (2) Velcro Straps
- (2) Plastic Cinch Straps

Please check the contents of your kit box with these diagrams.
If any parts are missing, contact SIG Mfg. Co. at 641-623-5154.

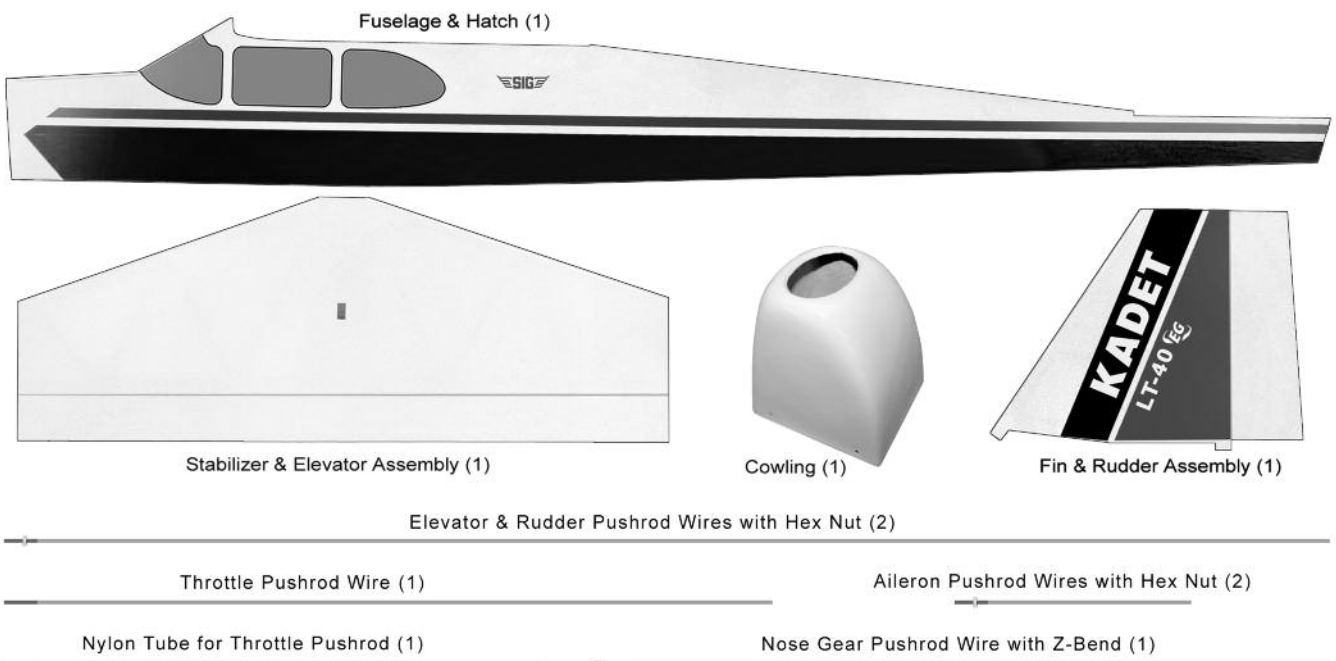

Please check the contents of your kit box with these diagrams.
If any parts are missing, contact SIG Mfg. Co. at 641-623-5154.

Right wing & Aileron (1)

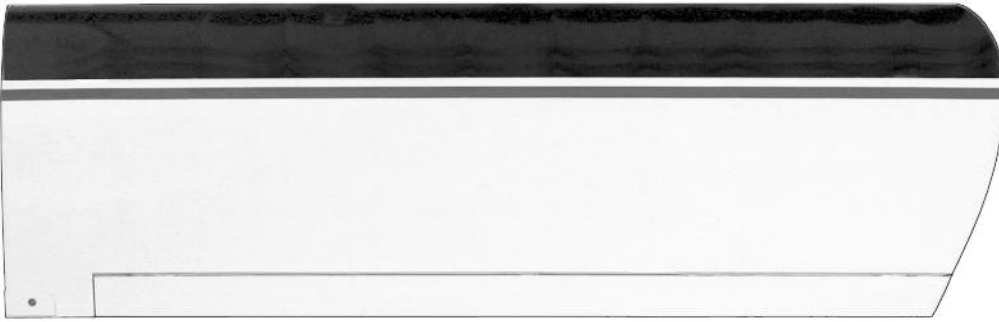

Electric Motor Mount Box (1)

Left Wing & Aileron (1)

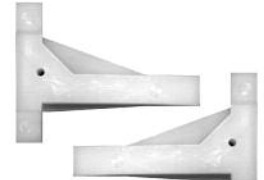

Glow Engine Mounts (1) Right, (1) Left

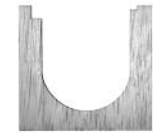

Plywood Fuel Tank Rear Support (1)



Aluminum Tube Wing Joiner (1)



Balsa Triangle (1)



Main Gear Wires (2)



Nose Gear Wire (1)



Landing Gear Straps (2)



3" dia. Wheels (3)



Wheel Collars (6)



Fuel Tank Parts (1 set)



Nose Wheel Steering Arm (1)



Balsa Block (1)



M3 x 15mm Screws for L.G. Straps (4)



Pushrod Connectors (2)



M3 x 10mm Screws for Cowling (4)



M4 x 16mm Socket-Head Bolts (8)



Nylon Wing Bolts (2)



Metal Clevis (4)



Nylon Clevis (1)



M4 Blind Nuts (4)



M4 x 25mm Slotted-Head Bolts (4)



Control Horns (4)



Fuel Tubing Clevis Keepers (4)



Pushrod Snap Keepers (4)



M4 Lock Nuts (4)



M4 x 30mm Slotted-Head Bolts (4)



M4 Lock Washers (4)



M4 Flat Washers (16)



Velcro Straps (2)



Plastic Cinch Straps (2)

The parts shown above are not all to the same scale. Smaller parts are unlarged for clearer viewing. You can measure the length of the bolts and screws using this metric ruler.

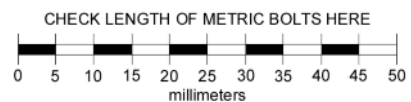

COVERING MATERIAL

Your KADET LT-40 ARF is covered with ORACOVER®, a premium quality covering made in Germany, and sold in the U.S. by Hanger-9® as UltraCote®.

Colors

- ORACOVER® #10 White (UltraCote® #HANU870)
and
- ORACOVER® #71 Black (UltraCote® #HANU874)
and
- ORACOVER® #23 Red (UltraCote® #HANU866)

If sometime in the future you need replacement covering or matching paint for repairs, they are available from your local hobby dealer or online from Hanger-9®.

How To Tighten Loose Covering

After you open your KADET LT-40 and take all the covered parts out of their plastic bags, the covering may begin to wrinkle. This is not unusual and is no cause for alarm.

Your airplane was built and covered in a part of the world which has relatively high humidity and therefore, the wood was likely carrying a fair amount of moisture. When exposed to drier air, the wood typically loses this moisture, dimensionally "shrinking" in the process. In turn, this may cause some wrinkles. However, wrinkles are easy to remove by just using a hobby type heat iron. CAUTION: Trying to remove the wrinkles by hastily going over them with a heat gun can lead to more problems. You should take your time to carefully go over the entire model with a covering iron, as we will describe.



We suggest using a model airplane covering iron for this process. Cover the iron's shoe with a thin cotton cloth, such as an old t-shirt, to prevent scratching the covering as you work.

After covering your iron, the next step is to set the iron to the correct temperature. This is critical for achieving a good result! The iron should be set to about **220°F - 250°F (104°C - 121°C)** as measured on the bottom of the iron using a thermometer.

If you do not have a thermometer, you can find the correct temperature by trial and error. Set your iron to a medium setting. Glide the iron over some of the covering that is over solid wood, such as the sheeted wing center section. Observe the covering to see if any bubbles appear. If bubbles appear, the covering is getting too hot! Turn down the temperature of the iron and repeat the test.

If no bubbles appear, turn up the heat slightly and repeat the test. Keep adjusting until you "zero in" on the correct temperature. Find the temperature that will get the covering to stick down without forming bubbles or causing the seams to pull away.

Once your iron is set to the correct temperature, go over the entire framework of the airplane, making sure that the covering is securely bonded to the structure everywhere the covering comes in contact with the wood underneath.

After you have all the covering secured onto the solid areas, turn the temperature of the iron up to approximately **300°F - 320°F (149°C - 160°C)**. This is the correct temperature for shrinking the covering material.

Use the iron to tighten up any wrinkles in the "open" areas of the model (no wood underneath the covering). Glide the iron over the wrinkle for a few seconds, then remove. Repeat until the covering is tight with no wrinkles.

If wrinkles keep coming back on the tail surfaces, you may need to "ventilate" the areas between the ribs. Otherwise the air that is sealed in those relatively small areas will expand when the heat is applied and actually cause the covering to stretch instead of shrink. Use a pin to poke a tiny hole in the covering between each rib, on the bottom of the part. That will let the expanding air escape and the covering to shrink properly.

Caution When Using Heat Guns: You can also use a hobby-type heat gun to shrink the covering, but you must be careful around seams or color joints. Getting too much heat on the seams may cause them to "creep" or come loose. You must also be careful when using a heat gun when working around the windshield and side windows - heat will distort the clear plastic material.

Recommended Temperatures:

To adhere the covering - 220°F - 250°F (104°C - 121°C)

To shrink the covering - 300°F - 320°F (149°C - 160°C)

NOTE: In this manual, any references to right or left refer to your right or left as if you were seated in the cockpit of the airplane.

WING ASSEMBLY

The wings are designed as a 2-piece system, with separate right and left wing panels joined by an aluminum tube wing joiner and a hardwood locating pin at the rear. Due to the high strength of the wing joiner tube, the wing panels do not need to be permanently glued together. Gluing them permanently together is optional - your call. The obvious benefit to leaving the wing panels separate is the fact that they can be easily transported or stored.

To help protect your wings during the following steps we recommend that you cover your work surface with a soft cloth or piece of soft cell foam.

HINGING THE AILERONS

□ 1) Note that the CA Hinges are installed, but not yet glued, in the ailerons and wing panels. The installation process for the hinges is the same for all of the control surfaces on this model.

a) If you removed the ailerons and hinges from the wing panels when you tightened the covering material, reinstall them now. First insert the four CA Hinges into the slots in the aileron. Put two pins in the center of each hinge, up against the leading edge of the aileron, to keep the hinges centered during the next step.

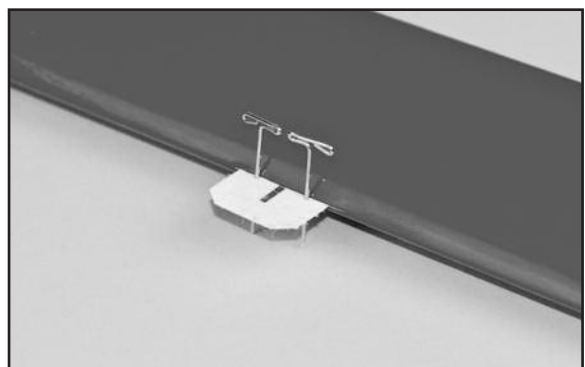

b) Now carefully insert the exposed portion of the four hinges into the trailing edge of the wing. You will find it easiest to slide the hinges into the slots at angle, one hinge at a time, instead of trying to push it straight onto all the hinges at once.

c) Adjust the aileron so that the tip of the aileron is flush with the wing tip. The ailerons should be tight against the pins in the hinges to minimize the gap between the wing and the aileron. The aileron is now in the proper position for permanently gluing them in place with thin CA glue.

d) Flex the aileron down and hold it in this position. Remove the pins from one hinge and then carefully apply 3-4 drops of Thin CA glue directly onto the hinge in the gap. You will notice that the glue is quickly wicked into the slot as it penetrates both the wood and the hinge. We suggest using a fine tipped applicator on the glue bottle to better control the flow of glue.



e) Turn the part over and glue the other side of the hinge. Continue this process until you have glued both sides of all the hinges! Keep a rag handy to wipe off any excess Thin CA glue. (If you get some glue smears on the plastic covering, don't worry about them right now. Once all the hinging is done, you can clean the smears off the covering with CA Debonder).

f) Let the glue dry 10-15 minutes before flexing the hinges. At first you might notice a little stiffness in the joint. This will go away after the hinges have been flexed back and forth a couple dozen times.

INSTALLING THE AILERON SERVOS

For the following steps you will need:

- (1) Right Wing Panel
- (1) Left Wing Panel
- (1) Aluminum Tube Wing Joiner
- (2) Servos with Mounting Screws (not furnished)
- (2) 6 in. or 9 in. long Servo Extension Chords (not furnished)
- (1) Servo Y- Harness (not furnished)

□ 1) Mount the aileron servos in the bottom of each wing panel.

a) Double check the covering around the servo openings in each with panel to make sure the covering is sealed down tight.

b) Install the rubber grommets and brass eyelets (supplied with your radio system) into each aileron servo.

c) Install the control arms on the two aileron servos. The arms should be at 90 degrees to the servo when the aileron control stick on the transmitter is in neutral and the transmitter trims are in neutral as well.

d) Before installing the aileron servos in the wing panels you must attach a servo extension chord to the aileron servo wire. The typical combined length of both chords is approximately 18" - in order to run from the servo mount at mid-wing to the receiver which will be mounted in the fuselage. A 6" or 9" extension chord should provide sufficient length, depending on exactly how long the servo's own wire is. Plug the servo plug into the extension chord and tape the plugs together for added security.

e) A string is provided in the wing panel for pulling the aileron servo chord through the wing. Each end of the string is taped on the outside of the wing panel. Carefully untape the string at the servo opening and tie the end of the string securely to the end plug of the servo wire, as shown.

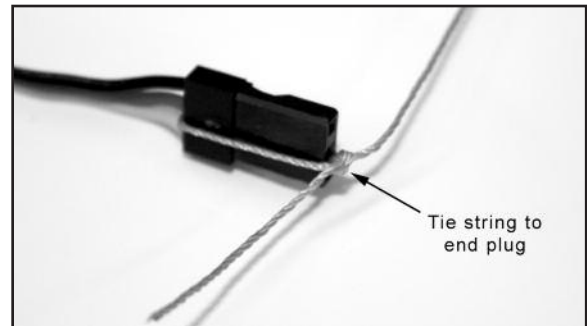
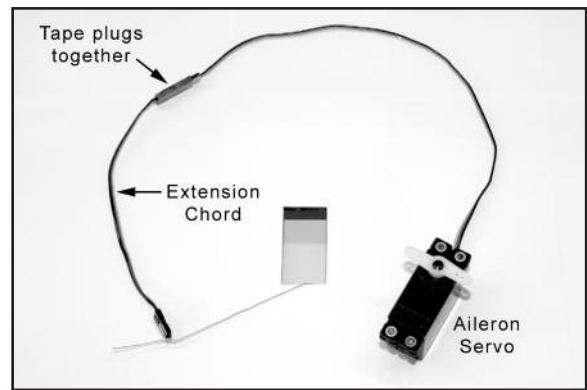

f) Untape the string at the root end of the wing panel and begin carefully pulling the string and the aileron chord through the wing. You will occasionally feel like the wire has become stuck inside the wing. This is simply the plug on the end of the servo wire hitting the side of one of the holes in the wing ribs. Gently work the string back and forth from both ends until the plug slips through the hole. Sometimes the servo plug comes through all the ribs the first time without getting hung up, and other times it seem like it gets hung up on every rib. Be patient and don't try to force it.



g) Fit the servo into the servo mount in the wing panel. Take up any slack in the servo chord as you insert the servo in the mount. Use a pin vise and a small drill bit to drill small pilot holes in the servo mount for the servo mounting screws. Use the screws supplied with your radio system to mount the servo in place on the servo mount. Repeat this procedure to mount a servo in the opposite wing panel.



INSTALL AILERON CONTROL HORNS & PUSHRODS

From the kit contents locate:

- (2) Nylon Control Horns
- (6) M2 x 15 mm Screws
- (2) 7-1/8" long Pushrod Wires with Hex Nut
- (2) Metal R/C Clevis
- (2) Pushrod Snap Keepers
- (2) small pieces of Fuel Tubing

□ 2) Mount one of the Nylon Control Horns on the bottom of each aileron by following these steps.

a) Cut apart the control horn and the clamping plate.

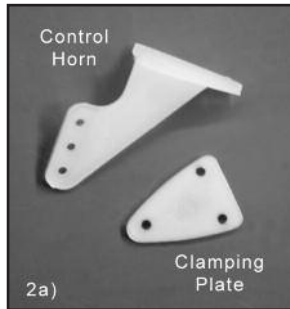

b) Look closely and you will see three holes pre-drilled in the bottom of each aileron for mounting the nylon control horn. Run your small drill bit through the holes to make sure they are open all the way through the aileron, including the covering.



c) Start each screw part-way into the holes in the control horn, as shown. Thread the screws in until the tip of each screw protrudes just slightly from the bottom of the horn base.

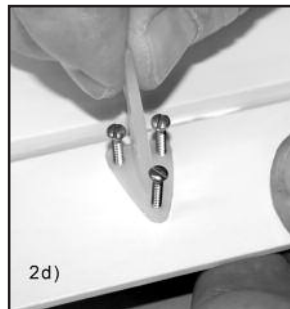

d) Set the horn in place on the aileron, pushing the tips of the screws into the holes in the aileron.

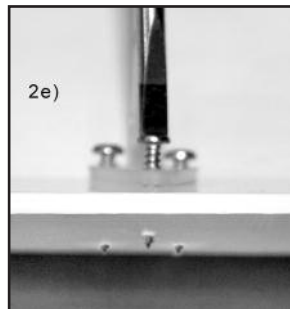

e) Thread the three screws through the aileron simultaneously, until the tips of the screws just begin to emerge from the other side of the aileron.

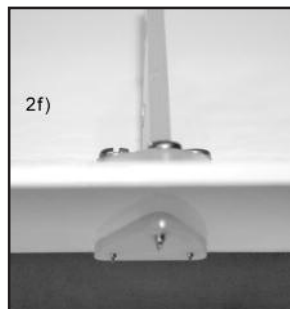

f) Then hold the control horn clamping plate in place while you finish threading the screws all the way in. When done, you can file or grind off the protruding sharp point of the screws if you desire.

g) Repeat Steps 2a to 2f to install a control horn on the other aileron.

□ 3) Next assemble and install the aileron pushrods.

a) Slide a short piece of Fuel Tubing onto the small end of the Metal R/C Clevis. Screw the Hex Nut on the Aileron Pushrod Wire all the way up to the end of the threads. Then screw the

metal clevis halfway onto the threaded end of the Aileron Pushrod Wire.

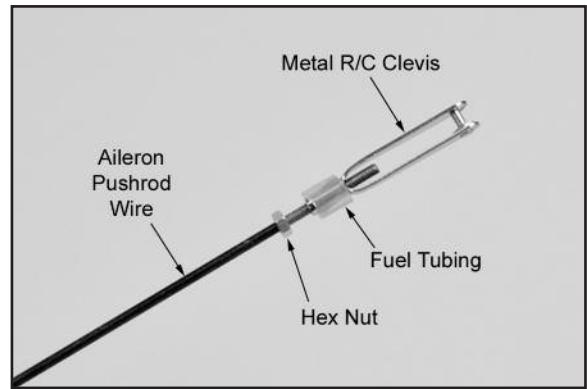

b) Clip the metal clevis into the last hole in the nylon control horn. Lay the other end of the pushrod wire over the outer hole in the servo arm. Use a felt tip pen to mark the wire where it crosses the hole. Use a pair of pliers to put a sharp 90-degree bend in the wire at the mark.

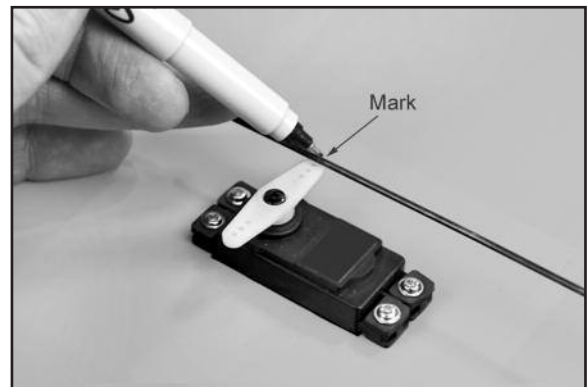

c) Insert the bent end of the pushrod into the servo arm, from the top. Note: You will most likely need to use a 1/16" dia. drill to open the hole in the servo arm to accept the pushrod wire.

d) Mark and cut off the excess end of the pushrod wire, leaving 1/8" of wire protruding below the bottom of the servo arm.

e) Clip a Nylon Snap Keeper in place on the servo end of the pushrod wire. Snap the free end of the keeper up and over the protruding end of the pushrod wire, underneath the servo arm.



f) Check that the aileron servo is in neutral position and adjust the metal clevis as needed to get the aileron in neutral position.

g) Once the ailerons are properly adjusted, insure that the metal clevis can't open up and come loose from the control horn by sliding the piece of Fuel Tubing over the arms of the clevis. Also tighten the M2 Hex Nut up against the back of the clevis.

h) Repeat Steps 3a to 3g for the other aileron pushrod.

□ 4) Test fit the two finished wing panels together with the Aluminum Tube Wing Joiner. Then test fit the wing assembly on the

fuselage. The tab that is formed by the two panels at the center, leading edge, fits into the cutout in the front fuselage former. At the rear, two M6.5 nylon wing bolts secure the wing to the fuselage. If you encounter any difficulties mounting the wing to the fuselage, find the problem and fix it now. Then remove the wing from the fuselage and set it aside.

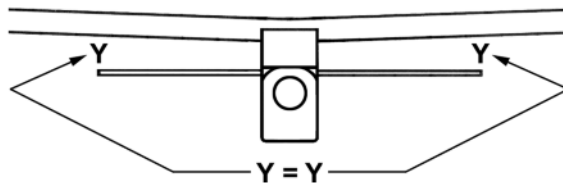

FUSELAGE ASSEMBLY

INSTALL THE TAIL SURFACES

For the following steps you will need:

- (1) Fuselage
 - (1) Wing
 - (1) Stabilizer & Elevator set
 - (1) Fin & Rudder Set
 - (1) Nylon Wing Bolts
 - (2) Nylon Control Horns with Clamping Plates
 - (6) M2 x 15 mm Screws
- 5) Notice that the Stabilizer & Elevator are hinged together, but the hinges are not glued in place. Refer back to [Step 1](#) on [page 6](#) of this manual for instruction on permanently gluing in the CA Hinges using Thin CA adhesive. Also glue in the Fin and Rudder hinges at this time. Let dry.
- 6) Next permanently glue the Stabilizer onto the fuselage.
- a) First test fit the stabilizer/elevator assembly on the fuselage. Eyeball the location as best you can, and then temporarily pin the stabilizer to the fuselage.

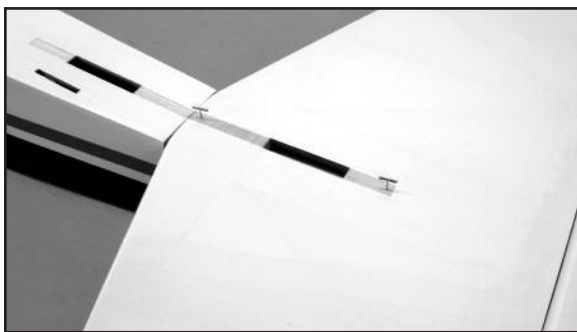

- b) Bolt the wing in place on the fuselage with the nylon wing bolts provided.
- c) Carefully check the alignment of the stabilizer to the wing. Use a tape measure to measure the distance from each stab tip to the back edge of the wing - the distance should be equal on both sides. Adjust if necessary.

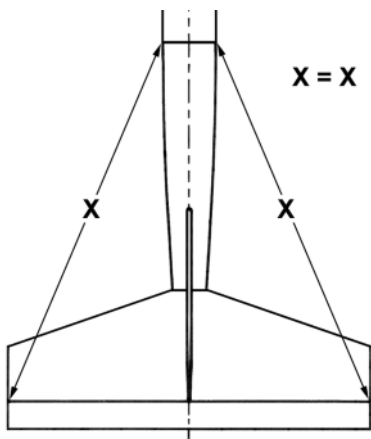

- d) Next view the model from directly in front. Check to see if the stabilizer is level with the wing. You should find it to be very close. If necessary use a sanding block to fine tune the stabilizer platform to level the stabilizer to the wing.

- e) Use a fine line felt tip pen to mark some guide lines on the stabilizer that will make it easy for you to realign the stab after the glue is applied in the next step. Then remove the pins and take the stabilizer off the fuselage for the next step.

- f) Glue the stabilizer permanently onto the rear of the fuselage. We suggest using slow drying epoxy glue for this job to allow time to position the stab accurately and make any final adjustments that might be needed. Use pins to hold stab in place. Re-check the alignment. Wipe away any excess epoxy with rubbing alcohol and a paper towel. Allow the glue to dry completely.

- 7) Mount a nylon control horn on the bottom of the elevator, using the same techniques you used for the aileron control horns back in Steps 2a to 2f on page 8. Three holes are already pre-drilled in the elevator for the mounting screws.



- 8) Mount a nylon control horn on the LEFT side of the rudder.



- 9) Test fit the fin/rudder assembly in place on top of the stabilizer. Check to see that the fin sits flush and perpendicular to the stabilizer. When satisfied with the fit, glue the fin in place using slow drying epoxy glue. Make sure the fin is 90 degrees upright to the stab. Let dry.

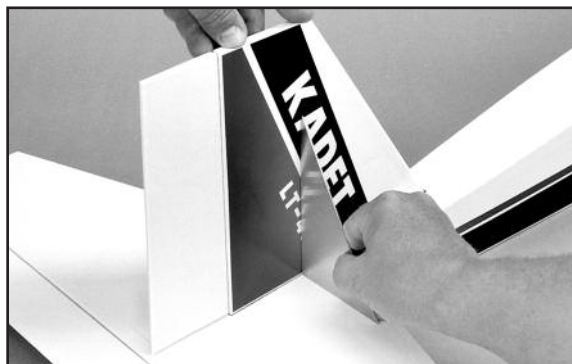

INSTALL THE LANDING GEAR

For the following steps you will need:

- (1) Fuselage
- (1) Fuselage
- (2) Formed Main Landing Gear Wires
- (1) Formed Nose Gear Wire
- (1) Nose Gear Steering Arm with Set Screw
- (3) 3" dia. Wheels
- (2) Nylon Landing Gear Straps
- (4) M3 x 15mm Screws
- (6) Wheel Collars

□ 10) Locate the two Main Landing Gear Wires and the Nose Gear Wire. Inspect the ends of all the wires for burrs. If any are found, use a file or sandpaper to remove them.

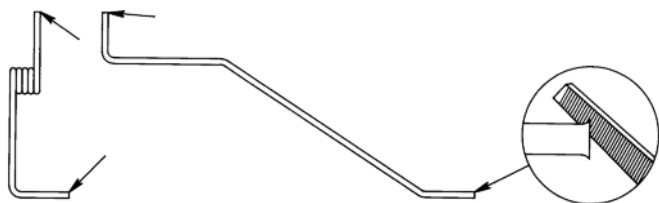

□ 11) Slide a wheel collar onto the axle of one of the main landing gear wires. Slide it all the way up against the bend of the wire, as far as it can go. Tighten the wheel collar set screw firmly. Then install a wheel and another wheel collar onto the axle. Make sure the wheel turns freely after you tighten the outer wheel collar. Repeat the process to install the wheel on the other main landing gear wire.

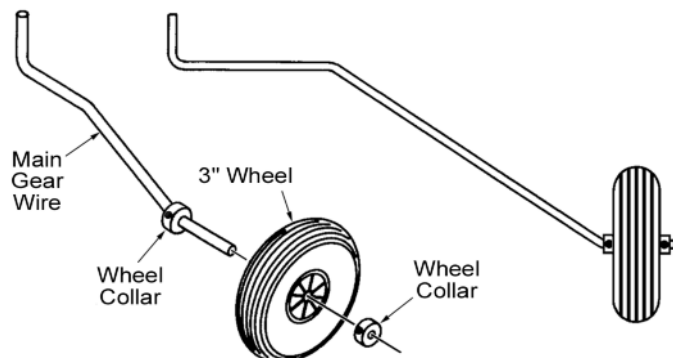

□ 12) Fit the main landing gear wires into the grooved block in the bottom of the fuselage. Holes have been pre-drilled in the block to receive the short upper arm of the gear wires. Push the wires down tight into the groove. NOTE: If the wire doesn't want to fit completely down into the groove of the landing gear block, it may be necessary to remove a little material from the inside edge of the hole to allow for the radius of the bend in the wire. Do this with a round file or modeling knife.

□ 13) Place the two nylon landing gear straps over the main gear wires as shown in the picture. Mark, then drill four 1/16" pilot holes for the screws. Use four M3 x 15mm Screws to mount the straps to the fuselage.



□ 14) Slide a wheel collar onto the axle of nose gear wire. Slide it all the way up against the bend of the wire, as far as it can go. Tighten the wheel collar set screw firmly. Then install a wheel and another wheel collar onto the axle. Make sure the wheel turns freely after you tighten the outer wheel collar.

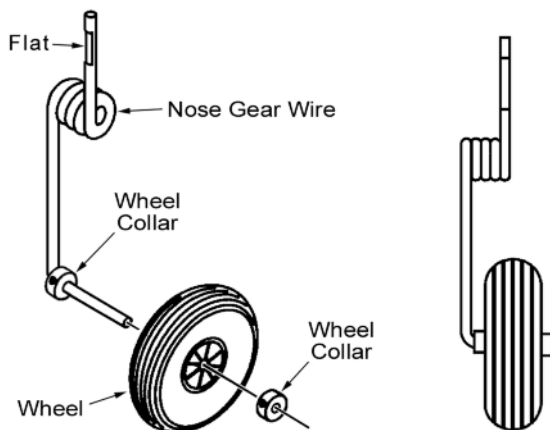

□ 15) Install the nose gear steering arm and nose gear wire into the nylon nose gear bearing that is already mounted onto the front of the firewall. But before you do, note that the front of the top leg of the nose gear wire has a flat spot which the steering arm set screw will engage.

Hold the steering arm in position in the nose gear bearing while you slide the top leg of the nose gear wire up through the holes in both the nose gear bearing and steering arm. When the top of the coil in the wire is approximately 3/16" - 1/4" from the bottom of the fuselage, tighten the steering arm set screw.

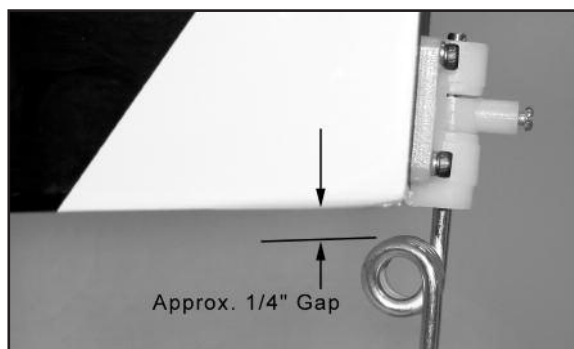

ELEVATOR & RUDDER PUSHRODS

For this section you will need:

- (1) Fuselage Assembly
- (2) 35-1/2" long Pushrod Wires with Hex Nut
- (2) Metal RC Clevis
- (2) small pieces of Fuel Tubing
- (2) Pushrod Snap Keepers
- (1) Radio Receiver (not furnished)
- (2) Servos with Mounting Screws (not furnished)

□ 16) Install the rudder and elevator servos inside the fuselage in the built-in plywood radio mounting tray. The rudder servo goes on the left side of the airplane, and the elevator servo goes on the right side. (The servo opening in the front of the tray is for the throttle servo in a glow installation.) Be sure to drill pilot holes through the plywood tray for the servo mounting screws.

□ 17) Install the rudder pushrod.

a) First slide a small piece of Fuel Tubing onto the small end of the Metal R/C Clevis. Next screw the Hex Nut that is on the Pushrod Wire all the way up to the end of the threads. Then screw the metal clevis halfway onto the threads.

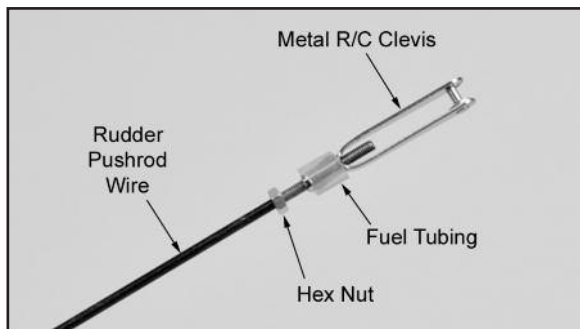

b) Locate the exit slot for the rudder pushrod on the top left side of the fuselage alongside the fin. Just inside the slot is the end of the rudder pushrod sleeve (tube) that is built into the fuselage. The sleeve extends from the slot at the rear, forward into the cabin area of the fuselage, and aligns with the rudder servo arm. Slide the plain end of the long rudder pushrod wire into the end of the sleeve at the tail end. Slide it in until you can clip the clevis into the outer hole of the rudder control horn.

c) Lock the rudder in neutral position. You can use tape to secure it in neutral; or another method that we prefer is to use two scrap balsa wood sticks or dowels, with small rubber bands holding them together at each end, to clamp the rudder in line with the fin (as shown in this photo).

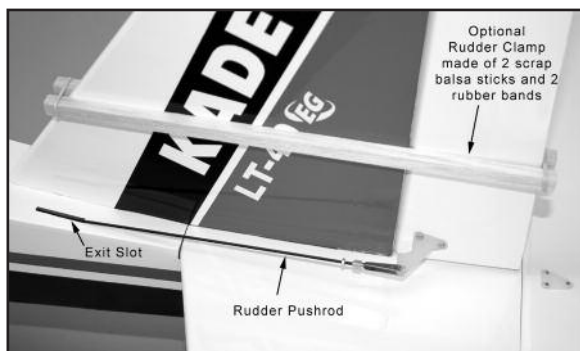

d) Inside the fuselage, hold the pushrod wire over the rudder servo output arm and mark the wire where it crosses over the outer hole in the arm. Make sure the servo is in neutral position.

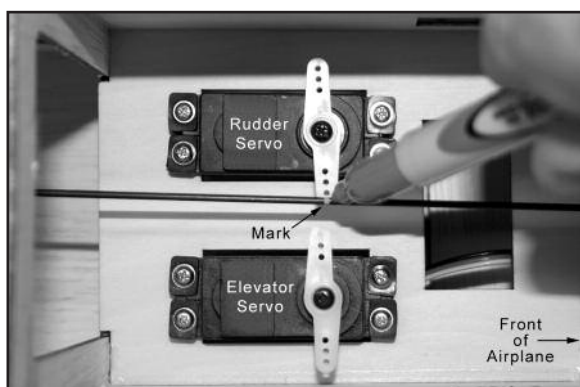

e) Unclip the clevis from the rudder control horn so that you can now pull the wire pushrod as far forward into the radio compartment as possible, to make it easier to complete this step. Mark and cut the servo end of the pushrod wire 1/4" past the mark you made in the last step. Then use a pliers to put a sharp 90-degree bend in the wire.



f) With the pushrod still disconnected from the rudder, remove the servo control arm from the servo. Install the servo arm and a nylon pushrod snap keeper on the end of the pushrod, as shown. Then re-install the servo arm on the servo.

NOTE: Drill out the holes in your servo arms with a #49 (.073") or 5/64" (.078") dia. drill bit so the pushrod wire will fit.

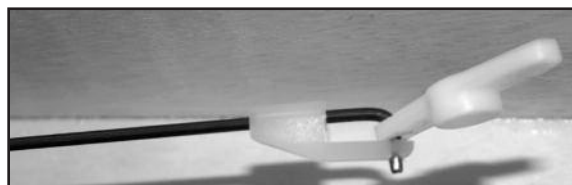

g) Make sure that the rudder servo is in neutral position and then adjust the metal clevis at the tail end as needed to get the rudder in perfect neutral position.

h) After the rudder is properly adjusted, insure that the metal clevis can't open up and come loose from the control horn by sliding the small piece of fuel tubing over the arms of the clevis. Also tighten the M2 Hex Nut up against the back of the clevis

□ 18) Locate the exit hole for the elevator pushrod inside the rear of the fuselage, and then repeat Step 17 in its entirety to install the elevator pushrod.

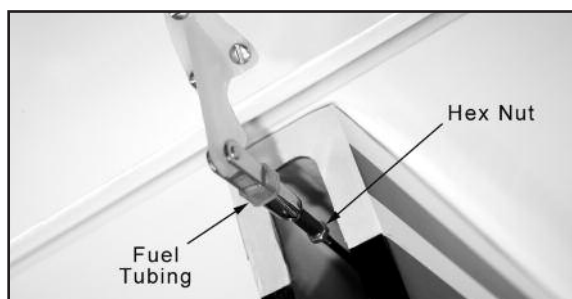

NOSE GEAR PUSHROD

For this section you will need:

- (1) Fuselage Assembly
- (1) 19-3/4" long Pushrod Wire with Z-Bend on one end
- (1) Metal Pushrod Connector

□ 19) The nose gear pushrod consists of a wire pushrod with a Z-bend on the end that hooks to the nose gear steering arm; and a metal pushrod connector on the servo end.

a) Begin by installing the metal pushrod connector in the rudder servo arm, with one hex nut on each side of the arm. Note that the pushrod connector goes on the opposite side of the servo arm from the rudder pushrod. Also, if your rudder servo arm has three holes in each side, put the pushrod connector for the nose gear in the middle hole.

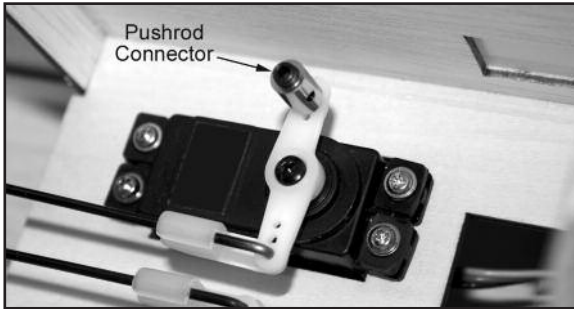

Tighten the two hex nuts of the pushrod connector securely against the top and bottom of the servo arm. If you take the set screw temporarily out of the pushrod connector, you can use a small screwdriver to go down through the connector body to hold the bolt, which makes it much easier to tighten the hex nuts.

b) Now slide the plain end of the nose gear pushrod wire into the fuselage from the front. You will find an easy path from the steering arm back to the rudder servo through the cutouts in the fuselage structure.

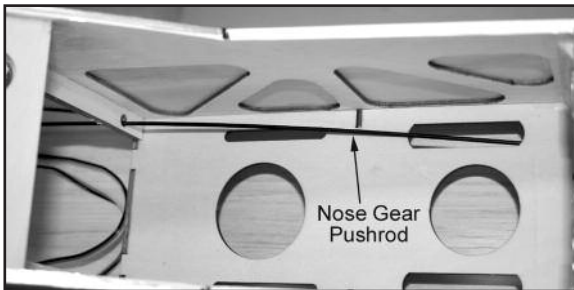

c) When pushrod wire reaches the rudder servo, insert the end of the wire into the pushrod connector.

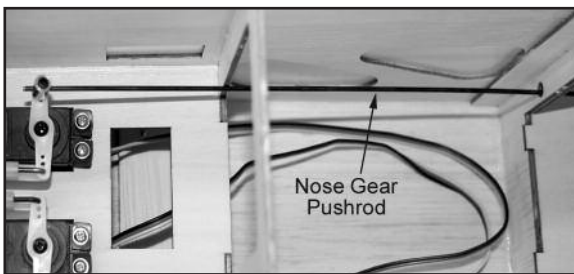

d) At the front, you will need to temporarily remove the steering arm from the nose gear bearing to hook it onto the Z-bend of the pushrod. Then re-install the nose gear.

e) Adjust the overall length of the pushrod by sliding it in or out of the pushrod connector until the nose wheel is straight when the rudder is straight. Then tighten down the set screw in the pushrod connector



ELECTRIC POWER SYSTEM

Skip this section if your using a glow engine power setup.

For this section you will need the Fuselage and:

- (1) Fiberglass Cowling
- (4) M3 x 10mm Screws
- (1) Plywood Electric Motor Mount Box
- (1) Balsa Triangle Stock
- (4) M4 x 20mm Socket-Head Bolts
- (4) M4 Flat Metal Washers
- (4) M4 x 16mm Socket-Head Bolts
- (4) M4 Split-Ring Lock Washers
- (4) M4 Blind Nuts
- (2) Velcro® Straps
- (1) Electric Motor, ESC, Prop, Lipo Battery (not furnished)

□ 20) *NOTE: The mounting of the electric motor in the KADET LT-40 assumes that your motor has a typical "X" or "cross" mounting plate on the back of the motor.*

Also note that the firewall portion of the laser-cut plywood motor mount is adjustable fore and aft to accommodate different length motors. In this step we will adjust the motor mount for your particular electric motor. For the KADET LT-40 we need a total distance from the back of the plywood motor mount box to the motor's thrust washer to end up exactly 4-3/8". This distance allows the cowling to fit properly.

a) Assemble your motor according to the manufacturer's instructions. Then carefully measure the distance from the back of the mounting plate to the front of the thrust washer*.

* *The "thrust washer" is the part of the prop adaptor where the back of the propeller will be located.*

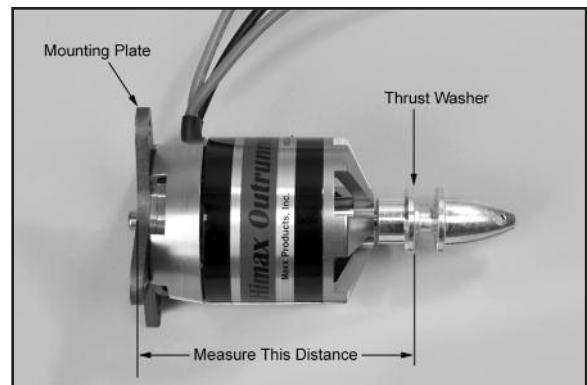

b) Subtract the measurement taken in the previous step a) from 4-3/8". The result is the distance you need to locate the front of the firewall from the back of the plywood motor mount box. (With the motor we are using in these photos, the motor

measurement is 2-7/8". So 4-3/8" minus 2-7/8" = 1-1/2". Your result may be different depending on your motor.)

c) Carefully measure and mark the distance determined in the previous step from the back edge of the motor mount box towards the front. Do this along side each of the adjustment slots on both sides of the box (four marks total).

d) After you have all four slots marked, carefully align the front face of the firewall to line up with the marks. Make sure you end up with the firewall straight and square in the box. If it is not, recheck your marks and adjust as necessary.

e) Tack glue the firewall in place. Recheck once more to make sure that the front of the firewall is at the correct distance from the back of the motor mount box. That distance plus the length of your motor must equal 4-3/8". When satisfied it is correct, glue the firewall securely to the rest of the motor mount box.

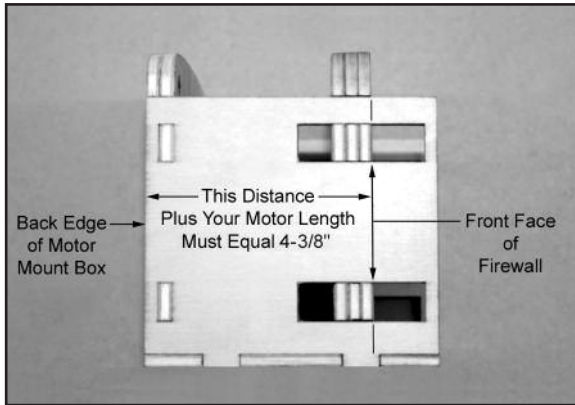

□ 21) Note the laser scribed lines on the front of the plywood firewall that indicate the airplane's thrust line.

a) Use a small straight edge and sharp pencil to extend the 45° scribed lines out to the edges of the plywood.

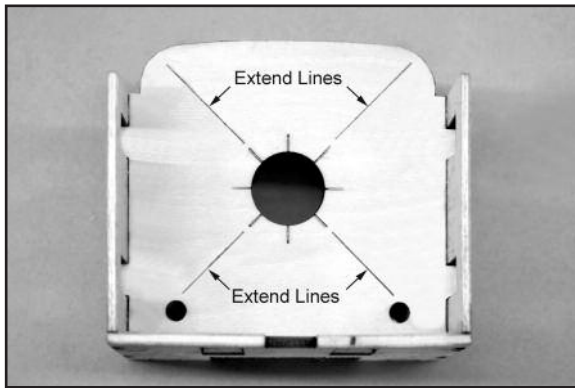

b) Remove the X mount plate from the back of your motor and center it on the firewall, using the lines as your guide. When you are sure it is properly located, mark the mounting hole locations.

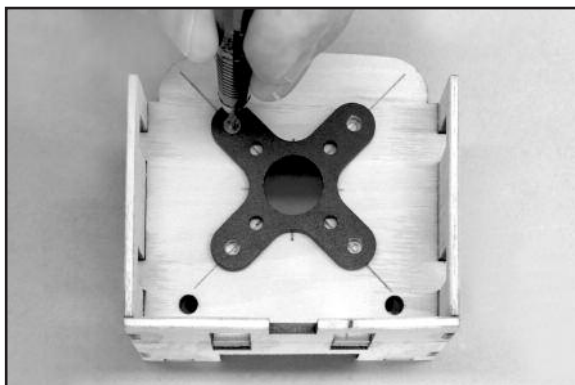

c) Set the X mount aside and drill out the mounting holes with a 7/32" dia. drill. Install four M4 Blind Nuts in the holes, on the

back side of the firewall. Put a couple drops of glue on the flanges of the blind nuts to secure them to the plywood. Be careful not to get any of the glue in the threads.

□ 22) A long piece of balsa triangle stock provided to reinforce the motor mount. Measure, cut and glue pieces of triangle stock in the corner joints of the motor mount box.



□ 23) Bolt the plywood motor mount box to the fuselage with M4 x 16mm Socket-Head Bolts and M4 Flat Metal Washers. Note that two access holes have been provided in the bottom corners of the firewall to allow easy access with a ball-end hex wrench.

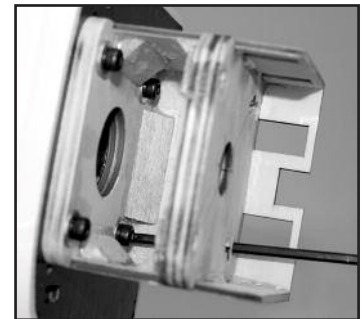

□ 24) If you have not already re-attached the X mount plate to the back of your motor, do so now. Then use (4) M4 x 16mm Socket-Head Mounting Bolts and Lock Washers to bolt your motor in place on the plywood motor mount box.

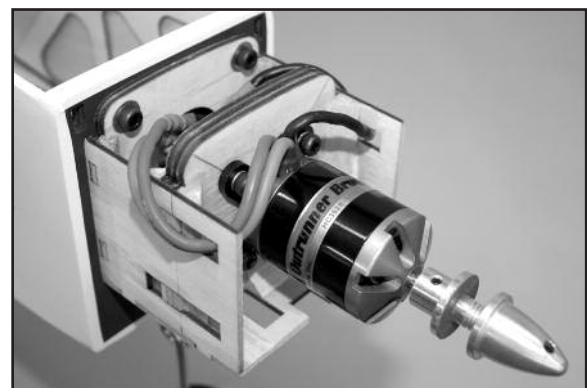

□ 25) Install your ESC

a) First solder appropriate battery connectors (not supplied) to the battery leads of your ESC.

b) Decide on a good location for the ESC in the nose of the airplane and figure out the best way of routing the motor wires. The most likely location to mount the ESC is against one of the fuselage sides, out of the way of the battery pack. Make sure the ESC is mounted low enough that it does not interfere with the fit of the Hatch. Trial fit the hatch to make sure. Mount the ESC to the airplane structure using a method of your choice - like double-sided tape or Velcro® (neither of these are provided).

c) Connect the ESC motor wires to the motor. You may wish to use a piece of household tape (any type) to secure the motor wires against the fuselage, so they will be out of the way during battery changes. The neater you can make your installation, the easier battery changes will be.

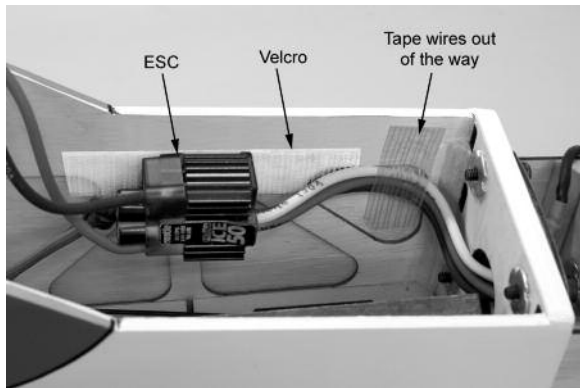

d) Route the ESC servo wire back to the receiver and plug it in. Operate the motor and check the direction of rotation. Always do this without a propeller attached, for safety! If you need to reverse the rotation, refer to the instructions that came with the motor and ESC. Normally it is just a matter of switching connection of one of the three motor wires to the ESC.

□ 26) Two velcro straps are provided to hold your lipo battery pack in place inside the fuselage. Feed the straps down through the slots in one side of the plywood battery tray, and then up through the other side, as shown in the photo. TIP: A sharp pointed hobby knife and a tweezers are helpful for this task.

Note: The two velcro straps can be shortened to fit your battery packs. Typically batter packs suitable for the KADET LT-40 will not need the full length straps. The excess length just clutters up the compartment. Trim off the plain end of the straps to achieve a length that fits your packs. For instance 3" was cut off the plain end of the straps shown in this photo, to eliminate clutter in the airplane and to make the straps easier to hook up.

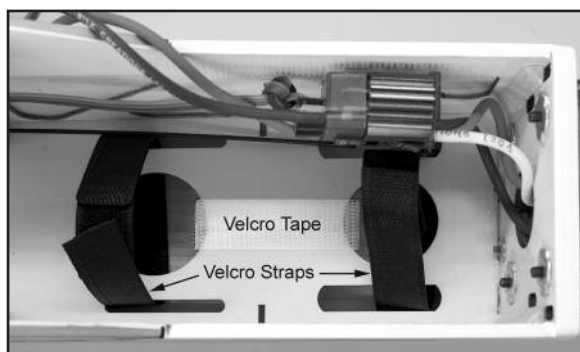

Make sure the neither the velcro straps nor the battery pack will interfere with the operation of the nose gear pushrod.

Optional: In addition to the two velcro straps, it is always a good idea to use regular velcro tape (not furnished) on the bottom of your battery packs, with the mating part on the top surface of the plywood battery tray. This will insure that your battery pack will not move around during flight.

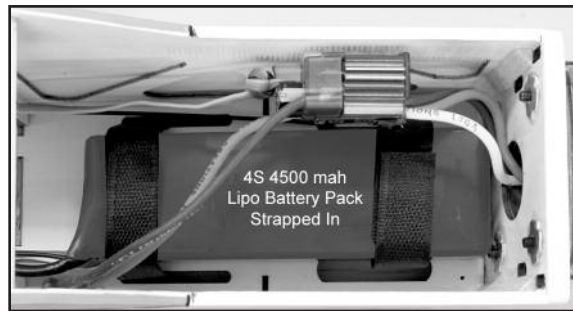

□ 27) Mount the cowling on the fuselage with the four M3 x 10mm Screws provided. Notice that the holes for the cowl mounting screws are already pre-drilled in the cowling.

a) First test fit the cowling on the fuselage. As you pass it over the motor, make sure all the wires are out of the way. Carefully adjust the exact position of the cowling. Make sure you have adequate clearance between the front of the cowl and the back of the propeller, and that the prop shaft is centered in the hole. Use low tack tape to hold the cowling in place for the next step.

b) Use a 5/64" or #45 bit to drill a pilot hole for the top left cowl mounting screw. Center the drill in the hole in the cowling and drill into the fuselage side. Install an M3 x 10mm screw in the pilot hole - do not over-tighten the screw.

c) Recheck the position of the cowling and make any adjustments needed to get it back in position.

d) Now drill another pilot hole for the upper screw on the other side of the cowling. Install the screw.

e) Repeat this process to install the two bottom cowl mounting screws. Remove all the tape.

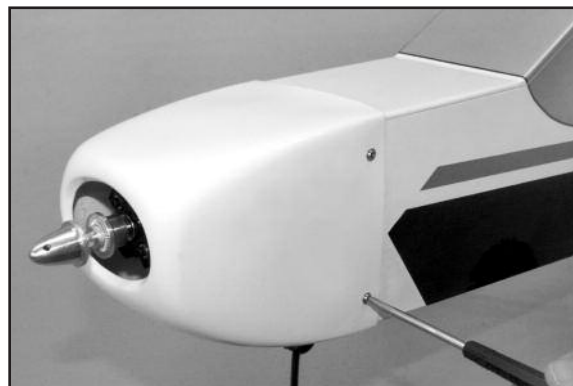

COOLING IS IMPORTANT!

With a fully cowled motor, it is very important to make sure your electric power system is getting proper cooling. Air flowing into the front of the cowling must have a place to exit the cowl. In fact it's best to have more air exit area than inlet area to create a positive air flow through the cowling - an actual suction effect - drawing the heated air out of the cowling so that more cool air can come in. This positive air flow keeps your motor running cool.

The KADET LT-40 cowling has a large opening in the front to let cooling air in, and a generous sized opening at the bottom rear edge of the cowling to let the air out. Cooling air can also exit the fuselage through the open tail end of the airplane. In most cases these openings should provide adequate cooling for your KADET LT-40.

OPTIONAL SPINNER: A Spinner is not supplied with this kit because most electric flyers will prefer let the maximum amount of cooling air enter the front of the cowling. If you wish to use a spinner the correct size is 2 inch diameter.

The installation of your electric motor system is now completed. Skip the next section on glow power system installation and proceed directly to Page 19 for your next steps.

GLOW POWER SYSTEM

Skip this section if your using an electric power setup.

The KADET LT-40 is a large airplane and is very adequately powered with the 2-stroke or 4-stroke engine sizes suggested. The airplane does not benefit from being over-powered. Doing this tends to put undue stress on the airframe without any real gain in performance. This airplane was always intended to "fly on the wing", not on excessive power.

The engine shown in these instructions is a typical .46 size 2-stroke engine. The engine is mounted in the upright position, providing easy access for field adjustments. The engine installation for either 2-stroke or 4-stroke power plants is basically the same. The main difference is often times the throttle arm location on the carburetor. The materials provided in this kit should be useful for almost any 2-stroke engine installation. Installation of a 4-stroke engine may require some alterations and/or specialized fittings (not supplied).

For this section you will need the Fuselage and:

- (1) Fiberglass Cowling
- (4) M3 x 10mm Screws
- (2) Nylon Engine Mounts
- (4) M4 x 25mm Slotted-Head Mounting Bolts
- (4) M4 x 30mm Slotted-Head Mounting Bolts
- (8) M4 Flat Metal Washers
- (1) Fuel Tank
- (1) Rubber Stopper Assembly
- (1) Fuel Pick-Up Weight (clunk)
- (1) Fuel Line Tubing for inside tank
- (1) Plywood Fuel Tank Support
- (1) Small Balsa Block
- (1) Nylon Throttle Pushrod Tube
- (1) 19-3/4" long Wire Throttle Pushrod
- (1) Metal Pushrod Connector with Set Screw and Hex Nuts
- (1) Nylon RC Clevis

You will also need to acquire these items (not supplied):

- (1) R/C Engine and suitable Propeller
- (3) 6 in. lengths of Silicone Fuel Line Tubing
- (1) Silicone Sealer (common kitchen & bath type)

FUEL TANK INSTALLATION

□ 28) Fuel Tank Assembly

a) Locate the Rubber Stopper Assembly. Note that there are three nylon tubes going through the rubber stopper.

One of the tubes will be used for the Fuel Pickup Tube, which will then connect to the engine carburetor.

Another tube will be used for the Tank Vent, which is most often then connected to the pressure fitting on the muffler.

The third tube can be used for a separate fill line if you desire, or it is more often capped off and the tank filling is done by removing the fuel line at the carburetor and filling through that line.

b) Orient the stopper so that one of the tubes is towards the top and then bend that tube up at a 45-degree angle. This tube will be the tank vent line. Do not apply heat to the tube - it will bend without heat. Just overbend it to nearly 90-degrees and then let it relax, to see where it will end up. Repeat if necessary until the tube will stay at 45-degrees.

c) Attach the metal Fuel Pick-Up Weight on one end of the silicone Fuel Line Tubing that goes inside the tank. Cut the other end of the fuel line tubing to a length that will allow the clunk to

reach the back of the tank, without getting stuck on the walls of the tank. Test fit in the tank and adjust as necessary. With the stopper assembly in place, the fuel clunk should sit just in front of the rear of the tank and move freely inside the tank. If not pull the assembly back out and trim the tubing back until the stopper moves freely. The top of the vent tube should rest just below the top of the tank. It should not touch the top of the tank.

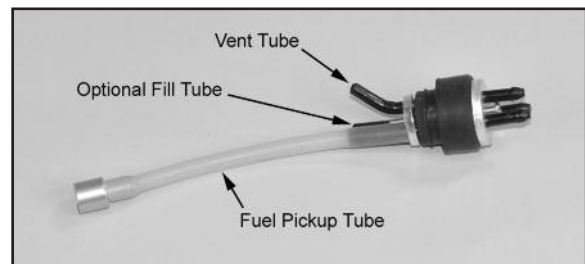

d) Once you are satisfied with the fit of both the fuel clunk line and the vent line you can tighten the screw to expand the rubber stopper and seal the stopper in the tank. Do not over tighten the screw as it can cause the tank to split. Attach three 6-inch lengths of silicone fuel tubing (not furnished) to the tank and label them appropriately as VENT, CARB, and OPTIONAL so you can identify them after the tank is installed in the airplane.

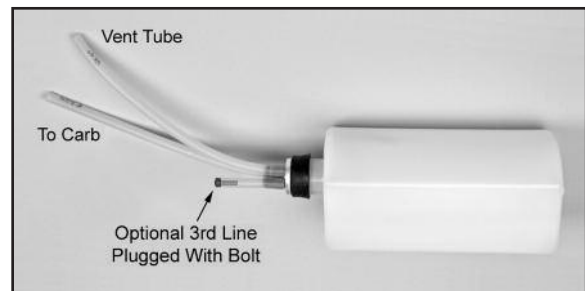

□ 29) The rear of the tank will be supported by a Plywood Fuel Tank Support. Notice that one side of the support has a notch to clear the nose gear pushrod. Glue the plywood fuel tank support securely in place.

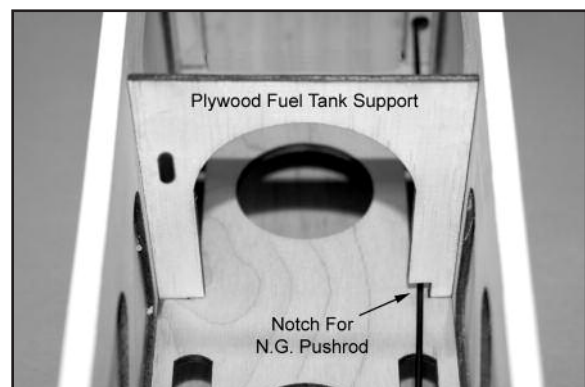

□ 30) Install the Fuel Tank in the fuselage.

a) First trial fit the tank in place inside the fuselage to familiarize yourself with the installation. Slide it in from the back, through the rear fuel tank support, and up to the back of the firewall. The neck of the tank will poke into hole in the back of the firewall. Take the tank back out for the next step

b) Apply a generous bead of "silicone sealer" around the neck of the fuel tank (household bathroom silicone sealer is available at most hardware stores - not furnished).

c) Then slide the fuel tank in place in the fuselage, up against the back of the firewall, with the neck of the tank in the hole in the firewall. If excess silicone sealer oozes out onto the front of the firewall, clean it off.

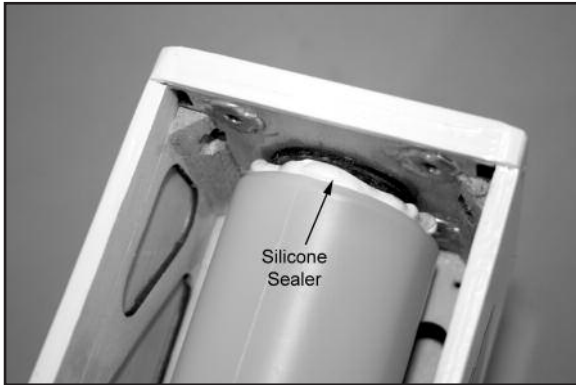
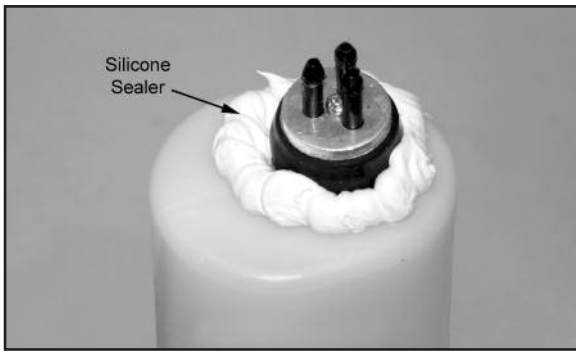

d) A small balsa wood block is provided as a stop to keep the fuel tank from sliding backwards. Glue the block to the tank floor, up against the back of tank.



ENGINE MOUNTING

The engine shown in these instructions is a typical .46 size 2-stroke engine. The engine is mounted in the upright position, providing easy access for field adjustments.

❑ 31) Bolt the two Engine Mounts on the front of the firewall, using M4 x 25mm Slotted-Head Bolts and M4 Flat Washers provided. The blind nuts are already installed in the back of the firewall. Look ahead to the next photo and note the proper orientation of the engine mounts, with the larger side-web towards the top. Also notice that the holes in the mounts for the bolts are slotted to allow you to adjust the spacing of the mounts to fit your engine. So leave the mounting bolts slightly loose for now. Do not tighten them until the next step.

❑ 32) Set your engine in place on the beams of the engine mounts. If the beams of the mounts are too far apart to fit your engine, slide the mounts closer together. If they are already too close together, slide them apart. After you get the mounts in correct position, tighten all four mounting bolts, securing the engine mounts on the firewall.

❑ 33) Slide the engine forward or aft on the engine mounts until the front of the engine's thrust washer is 4-3/8" from the front of

the firewall. This is the correct distance needed for the cowling to fit properly.

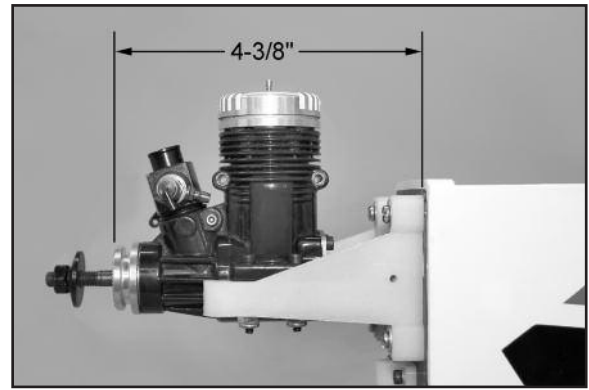

❑ 34) Double check to make sure that the engine is situated square on the mounts, and then carefully mark the locations of the engine mounting holes onto the beams of the engine mounts.

❑ 35) Now set your engine aside and unbolt the engine mounts from the firewall. Drill clearance holes for your engine mounting bolts all the way thru the engine mount beams at the four locations you marked in the previous step. We recommend that you secure the engine mounts in a vise while you drill the holes. Also, if at all possible use a drill press to drill these holes. You can drill them by hand, but if you have access to a drill press, the job will be much easier and the holes will be straighter.

ENGINE MOUNTING BOLTS: Four sets of M4 x 30mm Slotted-Head Mounting Bolts, Flat Washers, and Lock Nuts have provided for mounting your engine to the engine mounts (provided they will fit your particular engine). We realize that these M4 bolts may be too big for some engines. Engines in the .40 to .46 size range can vary in the size of mounting bolts required. In other words, some .40-.46 engines have small holes in their case for 4-40 bolts only; while other .40-.46 engines have holes large enough to accommodate 6-32 or M4 mounting bolts. If your engine is made for a smaller size bolts, you will have to obtain those bolts and nuts from your local hobby shop.

Drill 1/8" dia. holes for 4-40 mounting bolts (not supplied).
 Drill 5/32" dia. holes for 6-32 mounting bolts (not supplied).
 Drill 11/64" or #18 dia. holes for M4 mounting bolts provided.

SAFETY ISSUE: Do not drill and tap these engine mounts. Doing so may weaken them and cause failure. Drill holes in the mounts big enough to freely pass the bolts and then use lock nuts.

❑ 36) When you're finished drilling the holes, bolt the engine to the Engine Mounts. Then bolt the entire engine/engine mount assembly back onto the front of the Firewall. Tighten all bolts and nuts securely.

FUEL TANK COMPLETION

❑ 37) Connect the fuel tank to the engine using heat-proof silicone based fuel line tubing (not supplied). Recall from Step 28 the purpose for each fuel line.

The fuel tube that runs to the very back end of the fuel tank is the CARB feed line. Connect it to the engine carburetor.

The tube that goes to the top front inside the tank is the VENT line. Connect it to the pressure fitting on the muffler.

The third tank line is plugged shut in most Kadet installations. Plug it by putting on a short piece of fuel tubing and then plugging the tubing with a spare steel bolt. See photo next page.

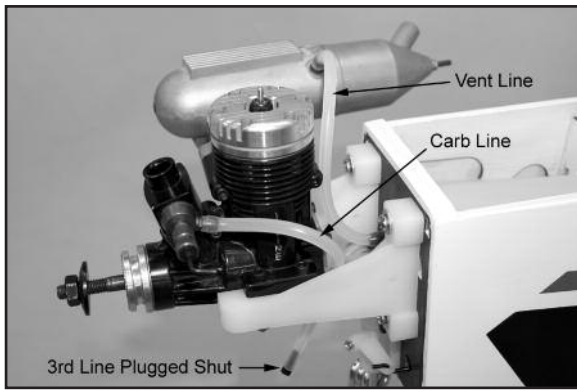

PROCEDURE FOR FILLING THE FUEL TANK

To fill the fuel tank when the 3rd line is plugged shut, first remove the other two fuel lines from the carburetor and the muffler pressure fitting. Pump the fuel into the tank through the fuel pick-up line (carb line). When the tank is full, fuel will begin to run out the vent line (muffler line). Stop pumping when you see the fuel start to come out the vent line! Re-connect the fuel lines and you are ready to start the engine.

THROTTLE PUSHROD

The supplied throttle pushrod assembly consists of a wire pushrod running inside a nylon pushrod tube. On the threaded end of the pushrod you will have a Nylon RC Clevis. For a typical 2-stroke installation we prefer to connect this end of the pushrod to the carburetor arm. The plain end of the pushrod wire will connect to the throttle servo using a Metal Pushrod Connector.

❑ 38) The first step is to install your throttle servo in the fuselage, using the rubber grommets, eyelets, and screws that came with the servo. Mount the throttle servo in the front opening of the servo tray, with the servo control arm to the front.

❑ 39) Install the metal pushrod connector in the throttle servo arm, with one hex nut on each side of the arm. You will need to drill out the hole in the servo arm with a 5/64" dia. (or #47) drill bit to accept the threaded portion of the pushrod connector. Tighten the two hex nuts of the pushrod connector securely against the top and bottom of the servo arm. If you take the set screw temporarily out of the pushrod connector, you can use a small screwdriver to go down through the connector body to hold the bolt, which makes it much easier to tighten the hex nuts.

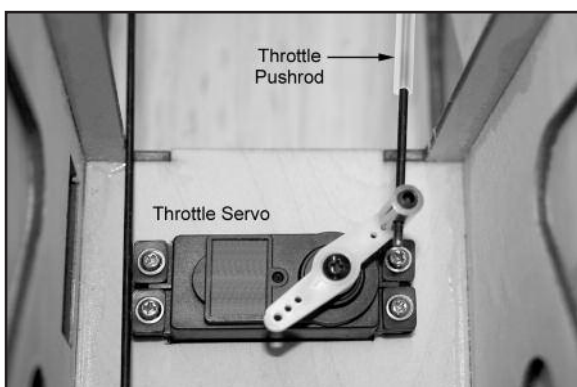
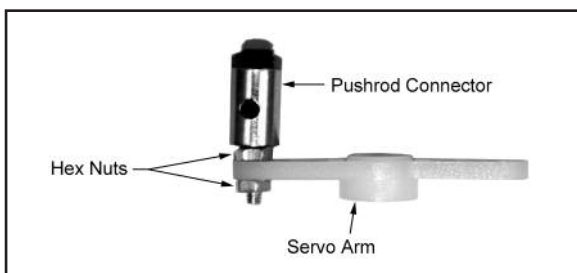

❑ 40) Screw the nylon clevis onto the threaded end of the pushrod. Then test fit the throttle pushrod wire in the airplane, sliding the plain end of the wire in from the front. Steer the pushrod through the slotted hole in the firewall; then through the hole in the rear tank support; and then back to the pushrod connector on the servo. Slide the end of the wire into the pushrod connector, but don't tighten the set screw at this time.

❑ 41) Now take a look at connecting the nylon clevis at the front of the pushrod to the carb arm. With a typical 2-stroke engine you will most likely find that the clevis does not line up with the carb arm. If that is the case simply take the pushrod back out of the airplane and use a pliers to bend the end of the pushrod in an offset pattern, as shown below, using two 45° bends. In our installation we needed to offset the end of the pushrod about 3/8" in order to line up directly with the carburetor arm.

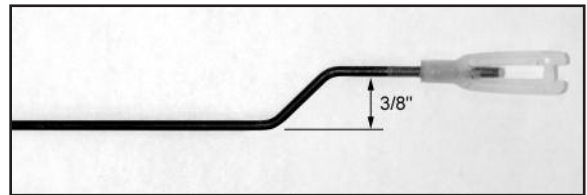

❑ 42) When you are ready to put the pushrod back in the airplane for the final time, first slip the Nylon Throttle Pushrod Tube over the pushrod wire. After you get the pushrod assembly in the airplane, adjust the location of the nylon tube so approximately 1" of the nylon tube is sticking out in front of the firewall. Then glue the tube to the plywood rear tank support, to keep it from moving.

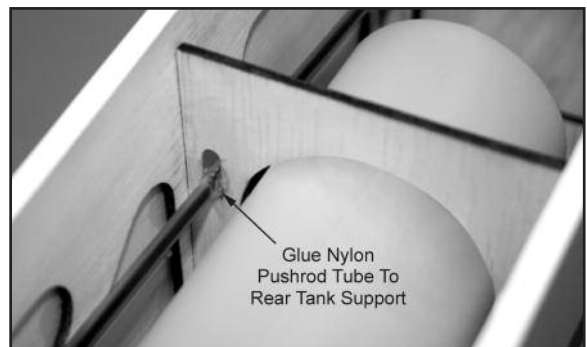
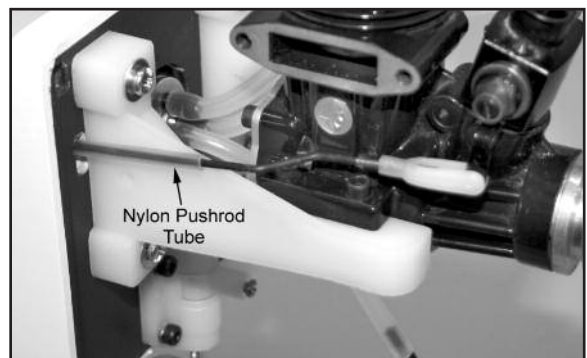

❑ 43) THROTTLE OPERATION

a) Clip the nylon clevis onto the carburetor and set the carb in the middle of its travel. Set the throttle servo in the middle of its travel and then tighten the set screw in the pushrod connector to secure the pushrod wire.

b) Turn on your radio and check the operation of the throttle pushrod. Make adjustments as needed to get full range of carburetor travel. You can adjust the overall length of the pushrod with either the nylon clevis or with the pushrod connector. Also use the EPA (End Point Adjustment) feature of your transmitter to accurately dial-in the desired amount of servo travel. Also

make sure there is no binding in the throttle linkage, which could cause unnecessary battery drain.

Ideally, this is the range of throttle moment you want to achieve:

STICK FORWARD
TRIM FORWARD
HIGH SPEED

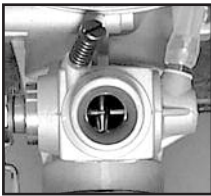

STICK BACK
TRIM FORWARD
GOOD IDLE

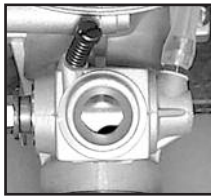

STICK BACK
TRIM BACK
KILL ENGINE

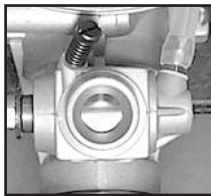

NOTE: Adjusting carburetor linkage can be a little tricky! If the throttle servo is binding or "stalling" because it has too much travel compared to the carburetor travel, try using your transmitter's End Point Adjustment "EPA" feature to dial in the proper amount of travel. If that doesn't work, you may need to move the pushrod connections to different holes in the servo or carburetor arm. You may also need to loosen the pushrod connector to re-adjust the overall pushrod length. All or some of these things may need to be adjusted to get the carburetor working properly.

COWLING

44) An opening needs to be made in the top of the cowling to clear the engine cylinder head and carburetor. Don't be tempted to quickly dive in with a knife and start removing large chunks of material. You will achieve a lot better result if you take the time to develop a pattern and mark it on the cowling for guidance when you are cutting.

a) Begin by marking a centerline on the top of the cowl.

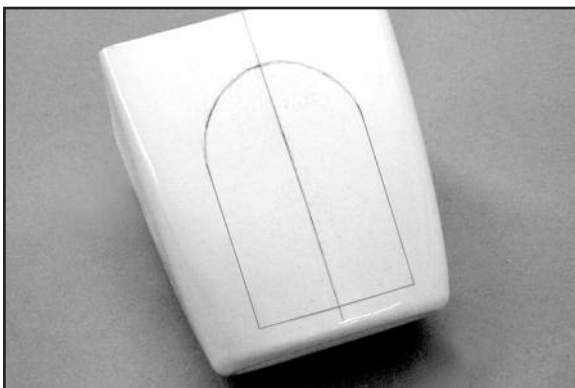

b) Then take width and length measurements off your engine and transfer them to the top of the cowl, using the centerline as the base reference point. The simple pattern shown in the previous photo was quickly made by measuring the diameter of the engine head and the overall length of the engine. It will serve as an undersize starting point for removal of material.

c) A Dremel® Tool, or similar powered hand-tool, with a 5/8" dia. coarse grit sanding drum is without a doubt the best tool to use for removing the material inside the lines quickly, easily and accurately. However, if you do not have access to such a power tool, you can cut the opening with a drill, a hobby knife, and a file - by first drilling a series of almost touching holes inside the pattern lines (1/8" dia. works well); then using the knife to cut through the connecting material between each hole; and finally finishing the edges of the opening with the file or a sanding block.

Be aware that there are no hard and fast "rules" for the exact perfect shape for openings in a cowling. Most important, make it big enough to provide the access you need to the engine. The best method is to "sneak up" on these openings, continually trial fitting the cowling over the engine until it finally fits properly. Once the

opening is big enough for you to slip it over the engine and place it in correct location on the model, then continue modifying the opening as needed to provide access to the needle valve and the fuel line tubing at the carb.

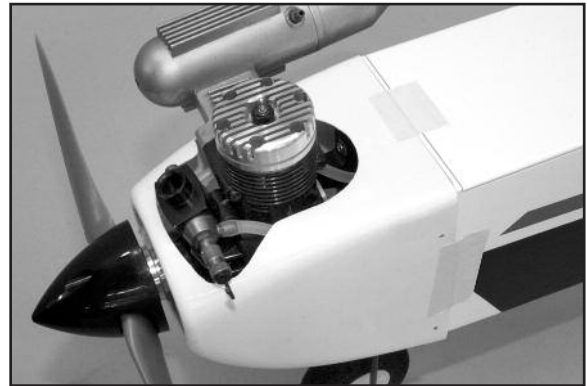

OPTIONAL SPINNER: This photo shows the use of an optional spinner, which is not supplied with this kit. If you wish to use a spinner the correct size is 2 inch diameter.

45) When satisfied with the opening in the cowling, mount the cowl to the fuselage with the four M3 x 10mm Screws provided.

a) Begin by placing the cowl over the engine and in correct position on the front of the fuselage. Be sure to leave a 3/32" to 1/8" gap between the front of the cowling and the back of the propeller, for clearance. Tape the cowling in correct position using a low-tack tape.

e) At the rear of the cowl there are four small pre-drilled mounting holes - two on each side of the airplane. Use a 1/16" drill bit to make a guide hole through one of the cowl mounting holes and into the fuselage side. Install an M3 x 10mm screw into the drilled hole and screw it in place - do not over-tighten the screw. Recheck the overall fit of the cowl and make any adjustments needed to the tape to hold it in correct position. Then on the opposite side of the fuselage, drill another 1/16" guide hole and install a screw into that hole. Repeat this process for the remaining two cowl mounting holes. Remove the tape.



LATER ... BEFORE FLYING ... SEAL THE HATCH

After you finish the final steps of the radio installation on the next page, you should seal the Hatch/Windshield onto the fuselage to prevent fuel and exhaust residue from getting inside the fuselage. The reason we built a removable hatch into this airplane was to provide easy access to the battery compartment when using an electric motor for flight. Obviously, with a glow engine you do not need regular access to this area of the airplane. We recommend tack gluing the hatch in place with several small spots of glue along its edges. Then seal over the seams with either clear tape or white covering material (not supplied). This is reversible if you ever need access to the fuel tank in the future.

The installation of your glow engine is now completed.

FINISH THE RADIO INSTALLATION

Both glow and electric power users resume assembly here.

NOTE: The receiver and servos of different brand radios are not all the same size! Consequently, it is practically impossible for us to guarantee that every word and picture in this next sequence will pertain exactly to your installation. As you go along, you may notice some differences between your radio equipment and ours. Nonetheless, most of the radio system components will be close enough in size and appearance that you should be able to figure out for yourself how to handle any minor differences. Follow the instructions as closely as possible. If you have any questions, seek the advice of an experienced modeler. The installation of the control system in your new model is very important! It must be done correctly in order for your airplane to fly successfully.

RECEIVER BATTERY PACK

If you are using a receiver battery pack (which is all glow engine users, as well as electric motor users who are not using BEC, you will need to install your receiver battery pack inside the fuselage. Wrap the battery pack with a single layer of soft foam rubber (not supplied) to insulate it from vibration and shock. Use tape or rubber bands to hold the foam around the battery.

The battery pack can be located anywhere in the front of the fuselage that you can find room - from just behind the firewall on top of the fuel tank (if it is a thin flat pack); to the cabin floor just in front of the fuselage servos. The battery pack can actually be used as an aid to achieve proper "balance" of the airplane (coming up soon). For now, leave the receiver battery pack loose on the bottom of the fuselage in front of the servos. Later, when the Center of Gravity (CG) is established, the final position of the battery pack can be determined. At that time you can use the plastic cinch straps provided, or some other method, to secure the battery pack so it can't move around. Make sure the battery pack does no interfere with the operation of any pushrods.

RECEIVER ON/OFF SWITCH

If you are using a receiver battery pack you will also be using a receiver on/off switch. The switch needs to be mounted in the fuselage side, so that it can be operated from the outside of the airplane when the wing is installed. With a glow engine it is always a good idea to mount the switch on the side away from the engine exhaust port/muffler.

A switch location has been laser cut into the left fuselage side, in the cabin area, underneath the covering. Use a sharp hobby knife to trim the covering material away to open up the switch mount. Trial fit your switch. If necessary make alterations to the cutout to fit your switch. Then mount the switch in the fuselage side using the screws that came with the switch.

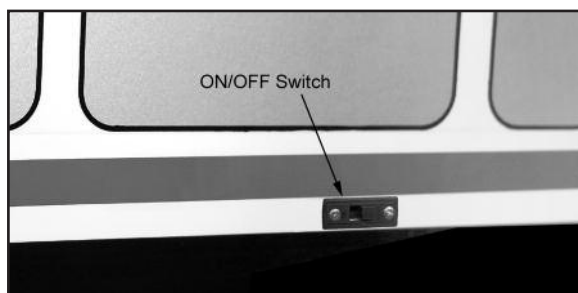

RECEIVER

Following the radio manufacturer's instructions, plug all the wires for the servos, battery pack, and switch harness into the receiver so the radio system is fully operational. Double check to be sure that each servo is plugged into its correct receiver port and that it is responding properly.

A standard "Y-harness" chord (not supplied) is needed to connect the two aileron servo chords to the receiver. Plug the single end of the Y-harness into the aileron port of the receiver. It will remain plugged into the receiver permanently, even when the wing is taken off the airplane. At the flying field, when putting the wing on the airplane, plug the two aileron servo chords into the twin plugs of the Y-harness. Then bolt on the wing.

Wrap the receiver in a layer of soft foam rubber to insulate it from engine vibration and shock. Use tape or rubber bands to hold the foam around the receiver. Secure the receiver in the cabin of the airplane. Mount the receiver antenna according to the radio manufacturer's directions.

CONGRATULATIONS!

Your KADET LT-40 is completely assembled. However, it is NOT ready for flight! There are a few very critical pre-flight tasks we must perform before flying. These are extremely important and should be approached with patience and care.

BALANCE YOUR AIRPLANE

This may be the single most important step in preparing your airplane for flight. All airplanes, model or full-size, must be accurately balanced in order to fly successfully. An airplane that is not properly balanced will be unstable and will most likely crash.

NOT ALL KADETS WILL BALANCE THE SAME

It is impossible to produce a model airplane kit that will automatically have the correct balance point. Not everyone uses the same engine/motor or radio gear - and all those items can vary in weight! You might be surprised to know that .40 size 2-stroke R/C engines can vary in weight from 11 oz. to 18 oz. - that's almost a half pound difference, way out on the nose of your model! There can even be as much as a 3/4 oz. difference in weight between different brands of propellers! So, that's why every model must be balanced before flying. Don't feel that whatever the balance point your model came out at is "good enough". Check carefully and make whatever adjustments are required. Trying to fly an out of balance model is dangerous!

Preliminary: To balance your KADET LT-40, all of the parts and components must be installed in their correct positions in the model. This includes all the radio gear, the propeller, muffler (if applicable), etc. Every piece of essential equipment must be installed, ready for flight. Always balance a glow powered model with the fuel tank empty. Always balance an electric powered model with the battery pack in place.

RECOMMENDED BALANCE RANGE Between 3-1/2" to 4-1/4" Behind The Leading Edge Of The Wing

(Anywhere within this range is acceptable.)

Using a ruler, measure back from the leading edge of the wing and mark the balance range on the bottom of the wing, next to the fuselage. Make the same marks on both sides of the fuselage. Place your fingertips within the balance range on both sides of the airplane and carefully lift it off the table. No part of the model should be touching anything except your fingertips! If the KADET LT-40 will sit on your fingertips in a level attitude, then it is properly balanced and ready to fly.

If the airplane sits on your fingertips in an extreme nose down attitude, then it is nose heavy. You will have to add weight to the rear of the airplane to get it to balance. NOTE: Before adding additional weight to the model, try simply moving the battery pack to a further aft location. The battery pack is relatively heavy and therefore makes a good balancing tool. You might try switching places between the battery and receiver. If you can't get your

model balanced simply by re-locating the battery pack, then you will have to purchase lead weights from your hobby dealer and glue them into the tail end of the fuselage.

If the airplane sits on your fingertips with the tail down, it is tail heavy. **DO NOT ATTEMPT TO FLY IT!** A tail heavy model is very dangerous and will most likely crash!! Weight will have to be added to the nose of the model to bring it into balance. The weights can be glued to the front of the firewall; or inside the cowling. There are also extra heavy spinner nuts available for tail heavy models. Wherever you put the balancing weight, make sure it cannot come loose in flight! Because the KADET LT-40 has so much wing area, adding balancing weight will have little effect on its flying ability.

CONTROL SURFACE TRAVEL

Double check the alignment and movement of all the controls one more time! Make sure none of the pushrods are binding or the servos stalling. Adjust all of your pushrod linkages so that the control surfaces are in their neutral position when the transmitter sticks and trim levers are centered. Make sure the control surfaces move in the proper direction when you move the sticks. You'd be amazed to know how many models have been destroyed on takeoff with one of the controls reversed. Don't let it happen to you! It's a good idea to get into the habit of checking for proper control response every time you get ready to fly.

Adjust your pushrod linkages and/or transmitter EPA (End Point Adjustment) settings as necessary to provide the recommended amount of control surface travel. **NOTE:** The rudder measurement is taken from the bottom of the rudder, at its widest point.

RECOMMENDED CONTROL SURFACE TRAVEL

AILERONS: 3/8" UP, 3/8" DOWN

ELEVATOR: 9/16" UP, 9/16" DOWN

RUDDER: 1" LEFT, 1" RIGHT

PRE-FLIGHT CHECKOUT

- Be certain to range check your radio equipment according to the manufacturer's instructions before attempting to fly.
- Run your engine for the first time on the ground. A lot of problems can be avoided if your new engine has been "broken in" by running at least two tanks of fuel through it on a test stand before you attempt to fly.
- Make sure all of the screws and bolts on your model are tight. Double check to see that all of the servos are secure, all of the servo control arms are screwed on firmly, all the R/C Links are clamped shut.
- Charge your radio batteries before every flying session!

FLYING

Do not try to fly your KADET LT-40 in your backyard, at the local school yard, or in any other heavily populated area! If you have never seen an R/C airplane of this size fly before, you probably don't realize how much room you really need. An area as big as three football fields, that is free of power lines, trees, poles, houses, and other obstructions is the minimum amount of room that you will need. A school yard may look inviting, but it is too close to people, buildings, and power lines.

The best place to fly your model is at a designated model airplane flying field. Ask your local hobby dealer or check online to

find out if there is an R/C club and flying field in your area. The local club field is the ideal place to fly your new Kadet! Joining the local flying club will not only give you access to a large, safe place to fly, but you will enjoy being around all types of R/C model airplanes and talking to their builders.

LEARNING TO FLY radio control model airplanes is not a skill you will learn in a few minutes. It's very similar to learning to fly a real airplane in that you should enlist the help of an instructor before you try to pilot the airplane yourself. A lot of things can go wrong with R/C airplanes, and if you are not prepared to deal with them instantly, you will lose your brand new airplane in a crash. To practically eliminate any chance that your first flight will end in disaster, we strongly recommend that you seek the assistance of a competent R/C pilot to help you with the first flights.

An instructor serves two purposes. First, he will take your model up for its first test flight to make sure it is performing properly before you try to fly it. When a brand new R/C model takes off for the first time, there is no way of knowing which way it is going to go. Some models will try to climb, while others may want to go down. Some will turn left, others right. Some models will be doing both at the same time! It doesn't mean that there is anything wrong with the model, but these minor differences must be "trimmed out" in order for the model to fly "hands-off" straight and level. An experienced pilot can instantly correct an out of trim model before it crashes to the ground. An inexperienced beginner has almost no chance of saving an out of trim model!

The second reason for an instructor is to have someone there who can correct any mistakes you make when you take over the controls for the first time. Let the instructor get the model airborne and flying straight and level at a safe attitude ("several mistakes high" as the old saying goes) before he turns the transmitter over to you. You will quickly find out that it is very easy to over control an R/C model and to get disoriented - **EVERYONE DOES IT AT FIRST!** If you get out of control on your first flight, quickly hand the transmitter back to your instructor so he can rescue the airplane. He will get it leveled off and then let you try it again. Without an instructor, you won't get a second chance!

In addition to not over controlling, another problem beginners need to overcome is the left/right control reversal that happens when a model is flying towards you one minute, away from you the next. For example, if you were seated in the cockpit of a full-scale airplane and moved the control stick to the right, the airplane would always turn to your right. Moving the control stick to the left, the airplane would always turn to your left. Well that's not always true with an R/C airplane! If the model is flying away from you, the controls are normal - right stick makes the airplane go right, left stick makes the airplane go left. But when the model is flying towards you, the controls are reversed - now when you move the stick to the right, the model turns to its right, but that means it turns to your left! This control reversal is very confusing to all first time R/C pilots! More than a few licensed full-scale pilots have found out that flying R/C airplanes is a lot different than flying full-scale airplanes because of this phenomenon.

It's not that learning to fly R/C is difficult, it's just a lot different than anything you have ever done before. Anyone can learn to fly the KADET LT-40 if they are willing to listen and learn!

Fly your KADET LT-40 as often as possible. After you get a few flights under your belt with an instructor at your side, you will begin to feel more comfortable at the controls. Soon you will be flying "solo" with little thought of the moves required. It will just come naturally! Don't get discouraged if you have a minor crack-up. Repair the damage and get back into the air as soon as possible.

GOOD LUCK AND SAFE FLYING!