

# ASSEMBLY MANUAL



# KADET SENIOR

**ALMOST READY TO FLY**



**KIT NO. SIGRC58EGARF**

**DESIGNED FOR ELECTRIC OR GLOW POWER**

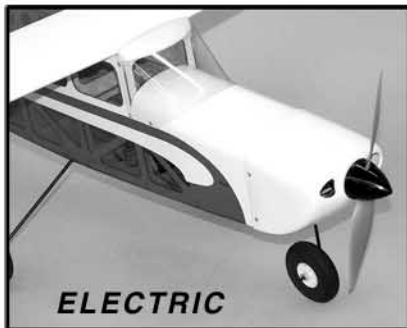

**ELECTRIC**

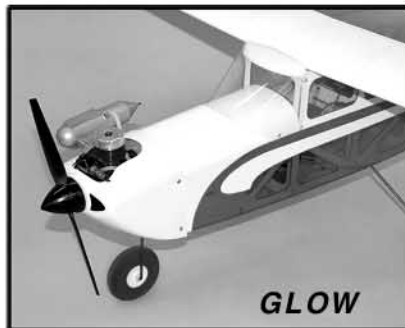

**GLOW**

**Wingspan:** 80.5 in. (2044.7 mm)  
**Wing Area:** 1180 sq.in. (76.1 dm<sup>2</sup>)  
**Length:** 64.75 in. (1644.6 mm)  
**Flying Weight:** 6 - 6.5 lbs. (2722-2948 g)  
**Wing Loading:** 11.7 - 12.7 oz./sq.ft. (36-39 g/dm<sup>2</sup>)

**Radio:** 4 Channel with 5 Standard Servos

**Glow:**

.40-.46 cu.in. (6.5-7.5 cc) 2-Stroke Engine  
.50-.61 cu.in. (8.1-10 cc) 4-Stroke Engine

**Electric:**

500 watt (3528-1000kv) Motor

# SIG MFG. CO., INC.

**PO Box 520 Montezuma, IA 50171-0520**

**www.sigmf.com**

**SIG**  
**KADET SENIOR**  
*ALMOST READY TO FLY* **EG**



**ASSEMBLY MANUAL**

**INTRODUCTION**

Congratulations on your purchase of the KADET SENIOR EG ARF. The KADET SENIOR has a long and illustrious history in R/C flying. It originally came on the scene in the early 1980s, designed by AMA Hall of Fame modeler Claude McCullough. The first KADET SENIOR was a build-it-yourself kit for 3-channel control - elevator, rudder, and throttle, with no ailerons.

The KADET SENIOR rapidly earned a reputation as the easiest to fly R/C trainer in the world. Tens of thousands of newcomers successfully learned to fly R/C with a KADET SENIOR. In addition, the versatile KADET SENIOR has been "kit bashed" for use in many other applications besides training - like float flying, banner and glider tow, aerial cameras, lights for night flying, etc. Many builders added ailerons to their wing for "full house" control. The KADET SENIOR'S light wing loading and slow flight characteristics are perfect for all these applications.

This ARF (almost ready to fly) version of the KADET SENIOR is 100% true to the original's outstanding flying characteristics, yet gets you into the air quickly. It also comes with ailerons as standard equipment! To make the ailerons more effective, the dihedral angle has been reduced from the original design. To make the airplane IMAA legal, the wingspan has been increased to 80-1/4". The increased span also increased the wing area to a huge 1180 sq. inches! The radio compartment in the fuselage is roomy enough for almost anything that you might want to carry aloft. All of this lifting capability still only requires a .40 - .46 2-stroke engine, a .50 - .61 4-stroke engine, or a 500 watt electric motor, to fly the airplane well.

We urge you to read this assembly manual completely before assembly. Familiarize yourself with the parts and their assembly sequences. The successful assembly and flying of this airplane is your responsibility. If you deviate from these instructions, you may wind-up with problems later on.

**If this is your first R/C Aircraft PLEASE READ THIS!**

As already mentioned, the KADET SENIOR ARF is a perfect model for learning to fly R/C. However, it is important to understand that if you have never flown an R/C model before, you will need to find a qualified R/C flight instructor to test fly the airplane and teach you how to fly it. If this is your first radio control model airplane, **DO NOT** attempt to fly it by yourself without a qualified instructor.

**ADDITIONAL ITEMS YOU WILL NEED TO PURCHASE**

In addition to this kit, you will need the following items to complete your KADET SENIOR and make it flyable.

**RADIO SYSTEM**

The KADET SENIOR ARF requires a standard 4-channel radio system and five standard servos. In addition, you'll need (2) 24" Servo Extensions and (1) servo Y-Harness for connection of the two aileron servos to the receiver.

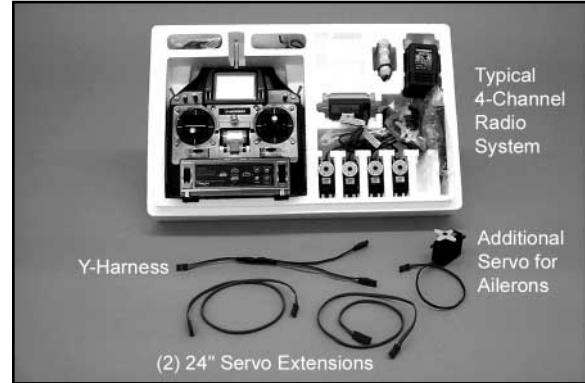

**POWER SYSTEM - GLOW OR ELECTRIC?**

The biggest decision you will have to make is whether to power your KADET SENIOR with a glow engine (2-stroke or 4-stroke) or an electric motor. We have flown the KADET SENIOR on a variety of both types of power systems, and we make the following recommendations based on our successful on-field experience.

**GLOW POWER RECOMMENDATIONS**

**ENGINE**

We recommend the following size for the KADET SENIOR ARF.

- 2-STROKE - .40 to .46 cu. in.**
- 4-STROKE - .50 to .61 cu. in.**

Don't let the large size of the KADET SENIOR fool you! Due to its huge wing area, very light wing loading, and slow flight envelope, these engines will provide ideal power for training or general sport flying the KADET SENIOR. In fact, we can tell you that we have flown a SENIOR carrying a half gallon of fuel on cross-country flights using a 1970s vintage classic K&B 40 (non-schnuerle) engine, without problem. Don't overpower the KADET SENIOR!

Whatever brand engine you choose, take the time to carefully break it in according to the manufacturer's instructions. A good running, reliable engine is a minimum requirement for the enjoyment of this or any R/C model aircraft.

**NOTE:** If you intend to use your KADET SENIOR for "heavy lifting", or choose a larger engine than listed above, please use caution. The light wing loading and light structure of the slow flying KADET SENIOR is designed to handle normal flight loads when using the above recommended engines for training and sport flying. If larger engines are used that result in higher speeds, or if heavy loads are being carried, the modeler is responsible for taking steps to reinforce the high stress points of the airplane to insure its structural integrity under those abnormal flight loads.

**PROPELLER FOR GLOW**

Refer to the engine manufacturer's instructions for recommendations on proper propeller size for their engine. In our experience, most 2-stroke .40-.46 glow engines will fly the KADET SENIOR very nicely with a 10x6 or 11-6 prop.

## ELECTRIC POWER RECOMMENDATIONS

### 500 watt BRUSHLESS OUTRUNNER MOTOR

We use the Maxx Products HC3528-1000 Brushless Outrunner Motor. dia.: 35mm  
length: 54mm  
weight: 197g (6.9 oz.)  
Kv = 1000  
Rm = .020  
Lo = 2.6

### MOTOR MOUNT

We use the Maxx Products #ACC3958 Large Motor Mount. This plastic cone-shaped mount provides the exact firewall-to-propeller distance needed to fit inside the KADET SENIOR cowling, without modifications. If you go shopping for another brand mount, you will need a mount that can provide 4-1/2" from the front of the firewall to the back of the propeller (or spinner if being used).

### 50-60 amp ESC (Electronic Speed Control)

We use the Castle Creations ICE 50 ESC or the Castle Creations Phoenix 60 ESC. We typically see amp draw of 30 to 48 amps, depending on whether a 3 cell or 4 cell lipo is being used, and the propeller size.

NOTE: The Castle Creations ESCs that we used, as well as the many of the other ESCs on the market, have a BEC (Battery Eliminator Circuit) built in. BEC allows you to use the same battery pack to power both your motor and your radio system, eliminating the normal radio battery pack. As the dual purpose battery runs down in flight, the BEC circuit in the ESC will shut down the motor and leave enough power to operate the radio while you land the model. However, the BEC feature in many ESCs does not work with 4 cell lipo battery packs - only 3 cell packs. Check the manual of your particular ESC to learn if this is true in your case.

If your ESC is only rated for 3 cell operation, you have three options: 1) fly only 3 cell lipo packs; 2) install the normal radio battery pack to run the radio full time; or 3) install an aftermarket BEC that is rated for 3 or 4 cells. We wanted to be able to fly both 3 cell and 4 cell packs interchangeably, so we elected to use the normal radio battery pack, since we already had it and the little bit of extra weight is no problem for the KADET SENIOR. We then disabled the BEC feature of our Castle ESC, since we no longer needed BEC. Disabling the BEC allows the speed control to be used with both 3 cell and 4 cell packs without problems. A common way to disable BEC in many ESCs is to remove or clip the middle wire from the plug on the ESC that goes into the radio receiver - see your ESC manual for more guidance.

### 3 or 4 cell 5300mah LITHIUM-POLYMER BATTERY PACK

With the Maxx Products HC3528-1000 motor we use 3 cell (3S1P) 5300mAh or 4 cell (4S1P) 5300mAh Li-po packs. A 3 cell pack (11.1 volts) provides flight performance similar to a .40 glow engine. A 4 cell pack (14.8 volts) provides flight performance similar to a .46 glow engine. We find that 5300mAh lipo packs provide between 10 to 18 minutes of flight time, depending on propeller selection and other factors (quality of pack, throttle management, outside temperature, etc.). CAUTION: You must match your propeller size to the cell count of your lipo pack, to avoid drawing too many amps and damaging your ESC or motor.

### PROPELLER FOR ELECTRIC

With a 3-cell (3S1P) 11.1v lipo pack, we recommend an APC 11x7E, APC 11x8E, or APC 12x6E propeller for the Maxx Products HC3528-1000 motor. All three sizes delivered good performance, very reminiscent of a 2-stroke .40 glow engine. For

a starting prop we recommend the APC 12x6E. Other brand propellers of same size and similar design can also be used. NOTE: Your results may vary due to other factors - the specs of your individual motor and battery pack, etc. You may need to experiment with different props to find your best combination.

With a 4-cell (4S1P) 14.8v lipo pack, we recommend an APC 10x6E, APC 10x7E, or APC 11x5.5E propeller for the Maxx Products HC3528-1000 motor. All three sizes delivered good performance, very reminiscent of a 2-stroke .46 glow engine. For a starting prop we recommend the APC 10x6E. Other brand propellers of same size and similar design can also be used.

### Hi-Maxx "COMBO 40" Complete System

Maxx Products, the manufacturer of the motor that we used in this manual, markets a "Combo 40" electric motor system. The Maxx "Combo 40" package consists of (1) Hi-Maxx HC3528-1000 Brushless Outrunner Motor; (1) Prop Adapter Assembly; (1) Castle Creations 50 Amp Speed Control (ESC); and (1) APC 12-6E Propeller. It's a good system for the KADET SENIOR.

Maxx Products, Inc.  
815 Oakwood Rd.  
Lake Zurich, IL 60047  
Web: www.maxxprod.com  
Ph: 847-438-2233

## REQUIRED TOOLS

For proper assembly, we suggest you have the following tools and materials available:

A selection of glues - SIG Thin, Medium, & Thick CA Glue  
CA Accelerator, CA Debonder  
SIG Kwik-Set 5-Minute Epoxy

Screwdriver Assortment  
Pliers - Needle Nose & Flat Nose  
Diagonal Wire Cutters  
Small Allen Wrench Assortment  
Pin Vise for Small Dia. Drill Bits  
Hobby Knife with Sharp #11 Blades  
Small Power Drill With Selection of Bits  
Dremel® Tool With Selection of Sanding & Grinding Bits  
Scissors  
Sandpaper  
Heat Iron & Trim Seal Tool  
Masking Tape  
Paper Towels  
Alcohol and/or Acetone For Epoxy Clean-up

## COMPLETE KIT PARTS LIST

The following is a complete list of all parts contained in this kit. Before beginning assembly, we suggest that you take the time to inventory the parts in your kit. Use the check-off boxes () provided in front of each part description. Please also note that the bolts and nuts required to mount your engine to the motor mounts are not included and must be purchased separately.

- (1) Fuselage
- (1) Right Wing Panel & Aileron, hinged
- (1) Left Wing Panel & Aileron, hinged
- (1) Horizontal Stabilizer & Elevator, hinged
- (1) Vertical Fin & Rudder, hinged
- (1) Cowling with (4) M2.6 x 10mm PWA Mounting Screws

Main Landing Gear

- (2) 5mm dia. Main Landing Gear Wires
- (2) 3-1/2" Dia. Main Wheels
- (2) Nylon Landing Gear Retaining Straps

- (4) M2.5 x 16mm PWA Screws
- (2) 5mm I.D. Plastic Wheel Spacers
- (2) 5mm I.D. Wheel Collars with Set Screws

#### Nose Gear Assembly

- (1) 4mm dia. Nose Gear Wire
- (1) 3-3/8" Dia. Nose Wheel
- (1) Nylon Nose Gear Steering Bracket
- (1) Nylon Nose Gear Steering Arm with Set Screw
- (4) M3 x 18mm Mounting Bolts
- (4) M3 Flat Washers
- (1) 4mm I.D. Plastic Wheel Spacer
- (1) 4mm I.D. Wheel Collar with Set Screw

#### Spinner Assembly

- (1) 2" dia. Black Spinner Cone
- (1) 2" dia. Black Spinner Backplate
- (1) Prop Adapter Rings
- (2) T3 x 10mm Phillips-Head Mounting Screws

#### Clear Plastic Side Windows

- (1) Side Window, Right Front
- (1) Side Window, Right Rear
- (1) Side Window, Left Front
- (1) Side Window, Left Rear

#### Aileron Servo Hatches

- (1) Right Aileron Servo Hatch, covered
- (1) Left Aileron Servo Hatch, covered
- (4) 3/8" x 3/4" x 3/4" Hardwood Servo Mounting Blocks
- (8) M2.6 x 8mm PWA Screws for servo hatches
- (4) M2 x 8mm PWA Screws for servo blocks

#### Control Horns

- (4) Nylon Control Horns; for ail(2); elev(1); rud(1)
- (2) Nylon Control Horn Bases; for elev(1); rud(1)
- (4) M2 x 20mm Mounting Bolts; for rud & elev control horns
- (4) M2.6 x 16mm PWA Screws; for aileron control horns

#### Pushrods

- (1) 3/8" dia. x 33-1/2" Wood Elevator Pushrod
- (1) 3/8" dia. x 22" Wood Rudder Pushrod
- (2) 1/8" O.D. x 19-3/4" Nylon Inner Pushrod Tubes; for throttle & nose gear
- (4) Heat Shrink Tubing
- (1) 2mm x 1-5/8" Pushrod Wire; threaded on one end, with "Z-bend" on other end; for nose gear
- (2) 2mm dia. x 3-5/8" Pushrod Wires; threaded on one end with "Z-bend" on other end; for ailerons
- (2) 2mm dia. x 4" Pushrod Wires; threaded on one end with "Z-bend" on other end; for rud & elev (servo end)
- (2) 2mm dia. x 11-3/4" Pushrod Wires; threaded on one end; for rud & elev (tail end)
- (3) M2 x 7/8" Threaded Studs; for nose gear pushrod (servo end) & throttle pushrod (both ends)
- (7) Metal R/C Links; for ail(2); rud(1); elev(1); thr(2); nose gear (1)

#### Miscellaneous

- (1) 5/16" x 3/4" x 4-9/16" Balsa Stick, for Fuel Tank Retainer
- (2) 1/4-20 x 1-1/2" Nylon Wing Bolts
- (1) Aluminum Front Wing Joiner Blade
- (1) Steel Rear Wing Joiner Pin
- (1) Decal Sheet

#### Fuel Tank for Glow Engine

- (1) Fuel Tank Body - 350cc (11.8 oz.)
- (1) Rubber Stopper
- (1) Metal Front Clamp
- (1) Metal Rear Clamp
- (1) M3 x 18mm Bolt
- (1) Metal Clunk Pick-Up
- (1) Fuel Tubing, inside tank
- (1) Aluminum Tube - 3mm od x 60mm
- (1) Aluminum Tube - 3mm od x 50mm
- (1) Aluminum Tube - 3mm od x 40mm

#### Engine Mounts for Glow Engine

- (1) Right Engine Mount
- (1) Left Engine Mount
- (4) M3 x 20mm Mounting Bolts
- (4) M3 Flat Metal Washers

*NOTE: "PWA Screws" are metal screws with a phillips/washer style head.*

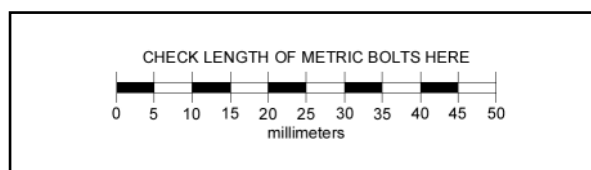

## COVERING MATERIAL

Your KADET SENIOR ARF is covered with Oracover™, a premium quality covering made in Germany, and sold in the U.S. by Hanger-9 as Ultracote™.

#### Colors

Oracover™ #10 White (Ultracote #HANU870)

and

Oracover™ #29 Transparent Red (Ultracote #HANU950)

or

Oracover™ #59 Transparent Blue (Ultracote #HANU954)

If sometime in the future you need replacement covering or matching paint for repairs, they are available from your local hobby dealer or online from Hanger-9.

#### How To Tighten Loose Covering

After you open your KADET SENIOR and take all the covered parts out of their plastic bags, the covering may begin to wrinkle. This is not unusual and is no cause for alarm.

Your airplane was built and covered in a part of the world which has relatively high humidity and therefore, the wood was likely carrying a fair amount of moisture. When exposed to drier air, the wood typically loses this moisture, dimensionally "shrinking" in the process. In turn, this may cause some wrinkles. However, wrinkles are easy to remove by just using a hobby type heat iron. Caution: Trying to remove the wrinkles by hastily going over them with a heat gun can lead to more problems. You should take your time to carefully go over the entire model with a covering iron, as we will describe.

We suggest using a model airplane covering iron for this process. Cover the iron's shoe with a thin cotton cloth, such as an old t-shirt, to prevent scratching the covering as you work.

After covering your iron, the next step is to set the iron to the

correct temperature. This is critical for achieving a good result! The iron should be set to about **220°F - 250°F (104°C - 121°C)** as measured on the bottom of the iron using a thermometer.

If you do not have a thermometer, you can find the correct temperature by trial and error. Set your iron to a medium setting. Glide the iron over some of the covering that is over solid wood, such as the sheeted wing center section. Observe the covering to see if any bubbles appear. If bubbles appear, the covering is getting too hot! Turn down the temperature of the iron and repeat the test.

If no bubbles appear, turn up the heat slightly and repeat the test. Keep adjusting until you "zero in" on the correct temperature. Find the temperature that will get the covering to stick down without forming bubbles or causing the seams to pull away.

Once your iron is set to the correct temperature, go over the entire framework of the airplane, making sure that the covering is securely bonded to the structure everywhere the covering comes in contact with the wood underneath. This takes some time, but is worth the effort.

After you have all the covering secured onto the solid areas, turn the temperature of the iron up to approximately **300°F - 320°F (149°C - 160°C)**. This is the correct temperature for shrinking the covering material.

Use the iron to tighten up any wrinkles in the "open" areas of the model (no wood underneath the covering). Glide the iron over the wrinkle for a few seconds, then remove. Repeat until the covering is tight with no wrinkles.



If wrinkles keep coming back on the tail surfaces, you may need to "ventilate" the areas between the ribs. Otherwise the air that is sealed in those relatively small areas will expand when the heat is applied and actually cause the covering to stretch instead of shrink. Use a pin to poke a tiny hole in the covering between each rib, on the bottom of the part. That will let the expanding air escape and the covering to shrink properly.

**Caution When Using Heat Guns:** You can also use a hobby-type heat gun to shrink the covering, but you must be careful around seams or color joints. Getting too much heat on the seams may cause them to "creep" or come loose. You must also be careful when using a heat gun when working around the windshield and side windows - heat will distort the clear plastic material.

**Recommended Temperatures:**

- To adhere the covering - 220°F - 250°F (104°C - 121°C)**
- To shrink the covering - 300°F - 320°F (149°C - 160°C)**

**WING ASSEMBLY**

Locate the following parts from the kit contents:

- (1) Right Wing Panel & Aileron
- (1) Left Wing Panel & Aileron
- (1) Right Aileron Servo Hatch, covered
- (1) Left Aileron Servo Hatch, covered
- (8) M2.6 x 8mm PWA Screws for servo hatches
- (4) 3/8" x 3/4" x 3/4" Hardwood Servo Mounting Blocks
- (4) M2 x 8mm PWA Screws for servo blocks
- (2) Nylon Control Horns
- (4) M2.6 x 16mm PWA Screws for control horns
- (2) 2mm dia. x 3-5/8" long Pushrod Wires; threaded on one end with "Z-bend" on the other end
- (2) Metal R/C Links
- (1) Aluminum Front Wing Joiner Blade
- (1) Steel Rear Wing Joiner Pin
- (2) 1/4-20 x 1-1/2" Nylon Wing Bolts

You will also need to acquire these items (not supplied):

- (2) Servos, standard size
- (2) 24" Servo Extension Chords
- (1) Y-Harness Servo Chord

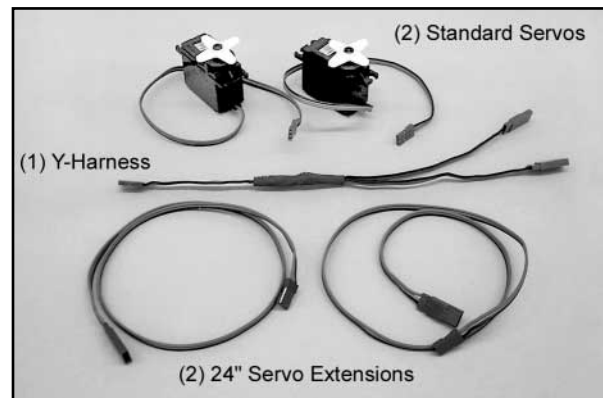

1) Note that the wing panels in your kit come with the ailerons permanently hinged in place. Give each aileron a gentle pull to the rear to double check that they are securely glued.

2) The aileron servos will be mounted on the back (uncovered) side of the plywood Servo Hatches.

a) To prepare the two hatches, use a ruler and sharp pencil to find the center of each hatch. Draw a center line all the way across each hatch, as shown.

b) Then draw two parallel lines, one on each side of the center line, exactly 1-7/32" away from the center line. The total distance between the two outer parallel lines should be 2-7/16". These lines mark the outer location limits for the two Hardwood Servo Mounting Blocks which will be mounted to each hatch.

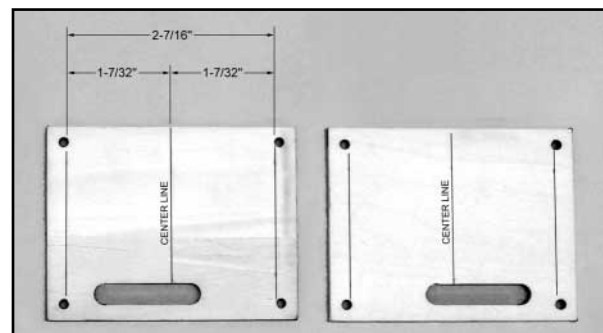

c) Hold one of the servos up against the back side of the hatch, with the servo arm centered in the pre-cut slot in the hatch. Mark the bottom of the servo grommets onto the hatch. Then draw a pencil line across the hatch at this mark (this line runs across the hatch, perpendicular to the other lines you drew).

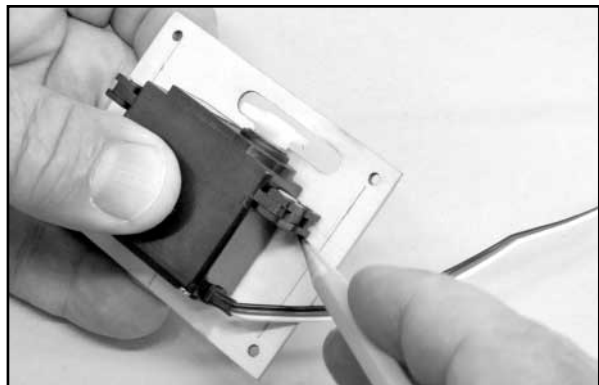

d) Use Medium CA or epoxy to glue two Hardwood Servo Mounting Blocks in position on the hatch, right up against the lines you drew on the hatch, as shown. Let dry.

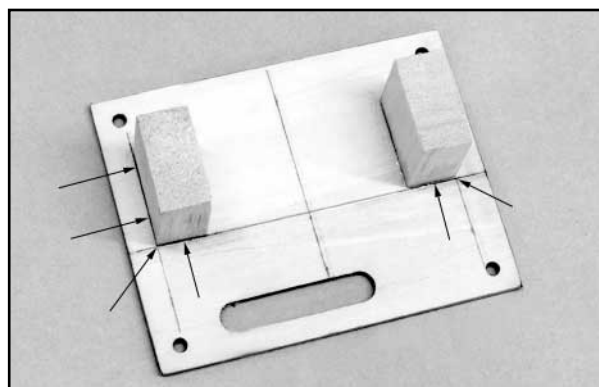

e) M2 x 8mm PWA Screws are provided to reinforce the mounting of the hardwood servo blocks to the hatch. Use a ruler to find the center of each block and mark it on the covered side of the hatch. Drill a 1/16" dia. pilot hole about 1/4" deep, through the hatch and into the mounting block. Install a screw in the hole. Repeat to install a screw in the other mounting block.

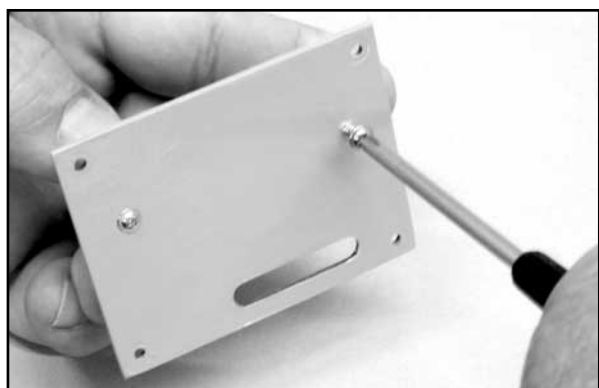

f) Mount your servo to the hatch, using the screws that were provided with the radio system. Be sure to drill pilot holes in the mounting blocks before screwing the servo in place.

g) Set up and turn on your radio system to center the servo and check servo travel. Install the servo arm. Check to see that the arm does not bind on the slot in the hatch at extremes of travel.

*NOTE: If you have a double-sided servo arm, cut off the side of the arm that you won't be using so that it cannot bind on the top of covering when the hatch/servo is installed in wing.*

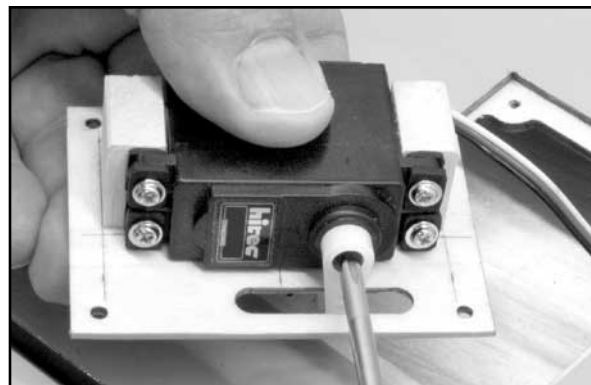

h) Repeat steps 2a) through g) to mount the other aileron servo to the other hatch.

3) Attach a 24" long servo extension chord onto the end of the aileron servo wire. Wrap the connection with a piece of plastic tape to insure that it won't come unplugged.

4) Inside the aileron servo bay in the bottom of the wing panel you will see a short balsa stick with a string tied to it. This string will be used to pull the aileron servo chord through the wing. You will find the other end of the string tied to another balsa stick that is inside the small round hole in the bottom wing sheeting, right next to the end rib.

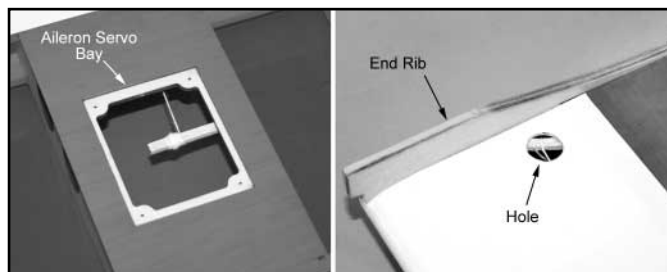

a) In the servo bay, gently break the small balsa stick loose from the wing structure. Pull it out and unwrap the extra string. Remove the wood from the string and discard it. Tie the end of the string securely to the end of the servo wire, as shown.

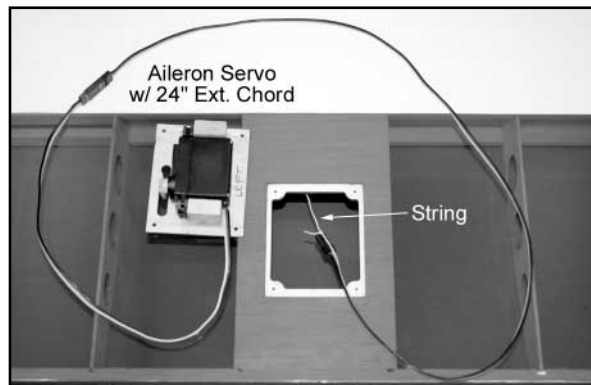

b) Break loose the balsa stick that has the opposite end of the string tied to it - from its location at the inboard end of the wing panel. Begin carefully pulling the string and the aileron chord through the wing towards the end of the wing panel. You may occasionally feel like the wire has become stuck inside the wing.

This is simply the plug on the end of the servo wire hitting the side of one of the holes in the wing ribs. Gently work the string back and forth from both ends until the plug slips through the hole. Sometimes the servo plug comes through all the ribs the first time without getting hung up, and other times it seem like it gets hung up on every rib. Be patient and don't try to force it. The holes in the ribs are large enough to get any common servo plug through.

c) When the servo plug appears in the round hole, reach in with a narrow needle nose pliers or a hemostat and grasp the plug and pull it out of the hole. Pull the servo lead fully out of the hole, leaving very little slack in the aileron servo bay. Remove the string from the servo plug and temporarily tape the plug to the wing surface so it can't fall back inside the wing.

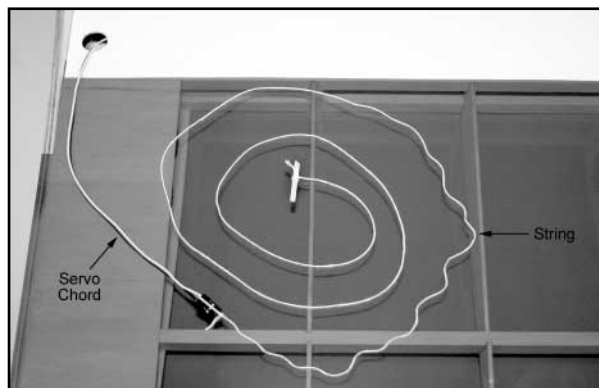

d) Repeat this step to pass the other aileron servo wire through the other wing panel.

e) Install the hatches/servos in place in the wing using the M2.6 x 8mm PWA Screws provided.

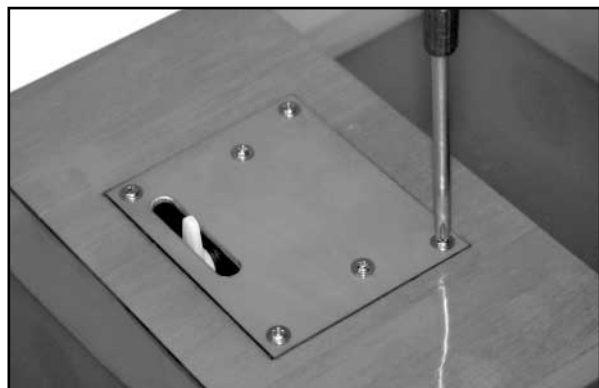

5) From the kit contents locate (2) Nylon Control Horns, (4) M2.6 x 16mm PWA Screws for mounting the control horns, (2) 2mm dia. x 92mm (3-5/8") long Pushrod Wires (threaded on one end with "Z-bend" on other end), and (2) Metal R/C Links.

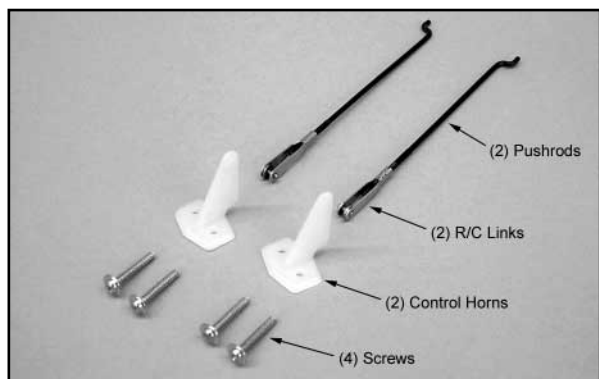

6) Install a Nylon Control Horn on the bottom of the aileron. Make sure the horn is directly in line with the servo arm, and that the base of the horn is right at the front edge of the aileron.

a) Hold the control horn in correct location on the aileron and use a pencil or sharp awl to mark the mounting hole locations for the control horn onto the surface of the aileron.

b) Drill a 3/62" dia. (or #56) pilot hole into the aileron at both marked locations. Do not drill completely through the aileron, just far enough to accept the mounting screws.

c) Mount the control horn in place using two M2.6 x 16mm PWA Screws.

d) Repeat this process for the other aileron.

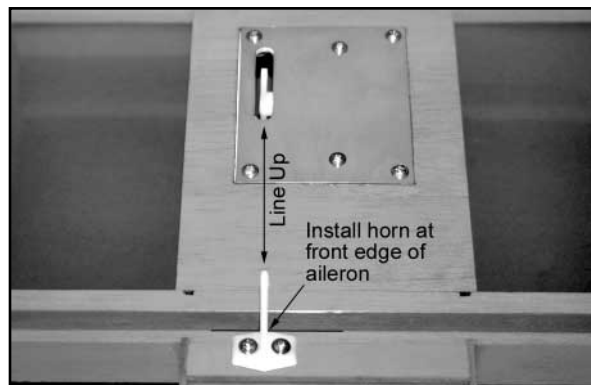

7) Before installing the pushrods you should hook your two aileron servos up to your radio system to check their operation.

a) Plug the two servo wires into the leads of a standard Y-Harness. Then plug the single end of the Y-Harness into the aileron slot in your receiver.

b) Turn on the radio system and center the aileron trim lever on the transmitter.

c) Check to see if the aileron servo arms are both perfectly centered on each servo - the arms should be perpendicular to the servo body when the servo is at neutral. If necessary take the servo arm off the servo and reposition to make it perpendicular. Don't forget to put the retaining screw back in the arm when done!

d) Now move the transmitter aileron stick to test for correct direction of travel and full motion of the servos. Note that the aileron servos should be moving in opposite directions to each other.

8) Installing the Aileron Pushrods

a) Thread the metal R/C Link on to the threaded end of the aileron pushrod. Thread it on about halfway for now, allowing for equal adjustment in either direction.

b) The end of the pushrod with the Z-Bend is the end that attaches to the servo arm. Install it in the last hole in the servo arm - the furthest hole from center. Note, you will need to drill out the hole in the servo arm with a drill bit to accept the pushrod wire. Use a #49 (.073") , a 5/64" , or a 2mm dia. drill bit.

c) With the aileron servo in neutral position, hold the R/C Link up against the side of the nylon control horn on the aileron. Determine if the length of the aileron pushrod needs to be adjusted so that the aileron is in neutral position when the servo is neutral. Adjust accordingly.

d) When you have the pushrod length approximately correct, snap the Metal R/C Link into control horn, using second hole from the bottom of the horn.

e) Turn the radio system on and double check that the aileron servo is in neutral position. Readjust the length of the aileron pushrod again if necessary so the aileron is also perfectly neutral.

f) Test the entire range of movement of the aileron. The movement should be smooth with good centering back to neutral.

If there is any binding, find the cause and fix it now.

g) Refer ahead in this manual to the section titled CONTROL SURFACE MOVEMENTS to learn the recommended amount of aileron travel. Use the EPA (End Point Adjustment) feature of your transmitter to achieve the recommended amount of aileron travel.

h) Don't forget to check that the ailerons are moving in the correct direction. Looking at the wing from the rear, moving the transmitter stick to the "left" aileron should cause the left aileron to move up and the right aileron to move down. If the movement is in the wrong direction, use the servo-reversing feature on your transmitter to reverse the direction of the aileron servos.

i) Repeat this process for the other aileron.

**SAFETY ISSUE:** After centering the servos and setting the control travel, "safety" each R/C Link by slipping a short length of fuel tubing (not supplied) over the link, as shown. This will prevent the R/C Link from opening up and becoming disconnected, which could lead to a tragic crash.



9) Test fit the two finished wing panels together with the Aluminum Front Wing Joiner Blade and the Steel Rear Wing Joiner Pin. Then test fit the wing assembly on the fuselage. The tab that is formed by the two panels at the center, leading edge, fits into the cutout in the windshield former. At the rear, two 1/4-20 x 1-1/2" nylon wing bolts secure the wing to the fuselage. If you encounter any difficulties mounting the wing to the fuselage, find the problem and fix it now. Then remove the wing from the fuselage and set it aside.

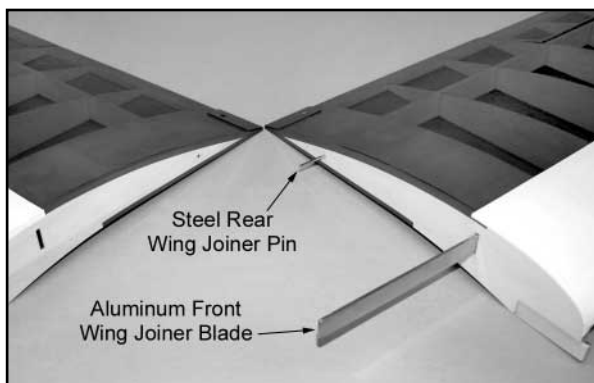

#### NOTE:

Any references to left or right, refers to your left and right as if you were seated in the cockpit of the airplane.

## GLOW ENGINE INSTALLATION

*Skip this section if you are planning to use an electric motor. Detailed instructions on installing an electric power system begin on page 11.*

The KADET SENIOR ARF is a large airplane and is very adequately powered with the 2-stroke or 4-stroke engine sizes suggested. The airplane does not benefit from being over-powered. Doing this tends to put undue stress on the airframe without any real gain in performance. This airplane was always intended to "fly on the wing", not on excessive power.

Note that the engine installation for either 2-stroke or 4-stroke powerplants is basically the same. The only differences being in the throttle arm locations on the carburetors and the muffler locations. The factory-installed throttle pushrod sleeve in the fuselage has been placed to exit the firewall on the right side of the fuselage. Note that it is not yet glued in place and is removable. This positioning is typical for the throttle arm location on most 2-stroke engines. If you plan to use a 4-stroke engine, it may be necessary to relocate the throttle pushrod sleeve over to the left side of the firewall to line-up with the 4-stroke engine's throttle arm. This is easy to do, using a long 1/4" dia. drill bit to drill a new hole (aligned with the engine's throttle arm) through the firewall and through the second fuel tank support former behind it.

Locate the following parts from the kit contents:

- (1) Right Glass-Filled Engine Mount
- (1) Left Glass-Filled Engine Mount
- (4) M3 x 20mm Phillips-Head Mounting Bolts
- (4) M3 Flat Metal Washers
- (1) 1/8" od x 19-3/4" Nylon Inner Throttle Pushrod Tube
- (2) M2 x 7/8" Threaded Studs for throttle pushrod
- (2) Metal R/C Links
- (1) 350cc (11.8 oz) Fuel Tank Assembly
- (1) 5/16" x 3/4" x 4-9/16" Balsa Stick
- (1) Cowling
- (4) M2.6 x 10mm PWA Screws for cowl mounting
- (1) Spinner Assembly, 2" dia., black

You will also need to acquire these items (not supplied):

- (1) R/C Engine and suitable Propeller
- (4) Socket-Head Engine Mounting Bolts
- (4) Lock Nuts for engine mounting bolts
- (4) Flat Metal Washers for engine mounting bolts
- (2) 6" lengths of Silicone Fuel Line Tubing
- (1) Silicone Sealer (common kitchen & bath type)

### ENGINE AND MOUNTS

The engine shown in these instructions, is a typical .46 size 2-stroke engine. The engine is mounted in the upright position, providing easy access for field adjustments.

1) Bolt the engine mounts in place on the front of the firewall with four M3 x 20mm mounting bolts and four M3 flat metal washers. Leave the mounting bolts slightly loose for the moment - do not tighten them until the next step.

2) Set your engine in place on the beams of the engine mounts. If the beams of the mounts are too far apart to fit your engine, slide the mounts closer together. If they are already too close together, slide them apart. Notice that the holes in the mounts for the bolts are slotted to allow you to adjust the mounts to fit your engine. After you get the mounts in correct position, tighten all four mounting bolts, securing the engine mounts on the firewall.



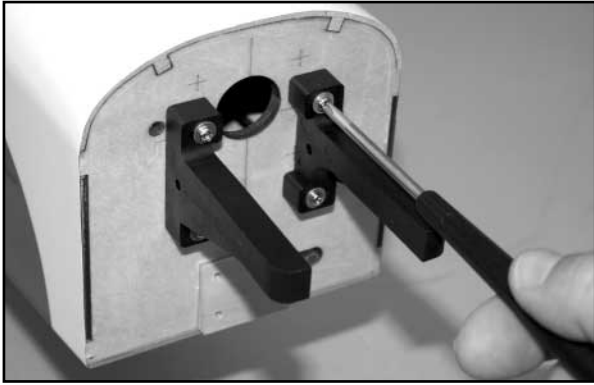

3) Slide the engine forward or aft on the engine mounts until the front of the engine's thrust washer is 4-1/2" from the front of the firewall.

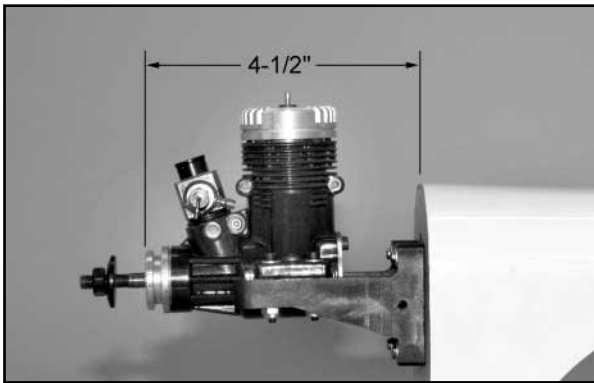

4) Double check to make sure that the engine is pointing exactly straight forward, and then mark the locations of the engine mounting holes onto the beams of the engine mounts, using a center punch or sharpened nail.

5) Unbolt the engine mounts from the firewall and drill holes thru the beams of the mounts at each location. We recommend that you secure the engine mounts in a vise while you drill the holes. Also, if at all possible, use a drill press to drill these holes. You can drill them by hand, but if you have access to a drill press, the job will be much easier and the holes will be straighter.

*NOTE: Engines in the .40 to .46 size range are right at the break point between using 4-40 size or 6-32 size mounting bolts. Some .40-.46 engines have small holes in their case for 4-40 bolts, while other .40-.46 engines have holes large enough to accommodate 6-32 bolts. Be sure to buy the size appropriate for your engine.*

Drill 1/8" dia. holes if you are using the 4-40 mounting bolts.  
Drill 5/32" dia. holes if you are using 6-32 mounting bolts.

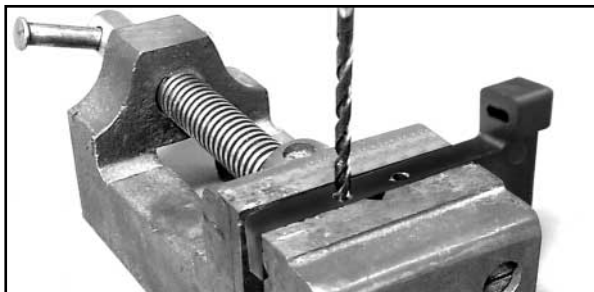

6) Re-assemble the engine on the engine mounts. Then bolt the entire engine and engine mount assembly in position on the

firewall. Tighten all bolts firmly. We suggest using a little thread lock compound (not supplied) on all the bolt threads to keep them firmly in place.

## FUEL TANK

We recommend that you plumb the fuel tank with a simple two-line fuel delivery setup. One fuel line will be connected from the carburetor to the fuel tank's pick-up or "clunk" line. To fuel or de-fuel the tank, this line is pulled off of the carburetor and attached to your fuel pump. The second fuel line will be connected from the fuel tank vent line to the pressure fitting on the muffler.

Note in the photos that the correct orientation of the fuel tank body in the airplane is with its neck towards the top of the tank.

1) Inside the tank is a piece of flexible fuel line tubing. Reach inside with a tweezers or needle nose pliers to get a hold of the fuel line tubing and pull it out. CAUTION: Don't squeeze too hard and put a hole in the tubing! Now shake the tank a few times to make sure there is no dirt or plastic shavings inside!



2) Take a close look at the rubber stopper. Notice that it has two open holes and one closed one. We will only be using the two open holes. Leave the third hole closed.

3) Assemble the front metal clamp, the rubber stopper, and the rear metal clamp with the bolt. Screw the bolt in, from the front, just enough to hold the front and rear clamps loosely against the rubber stopper. Do not tighten the bolt at this point. Rotate the front and rear metal clamps until their holes line up with the two open holes in the rubber stopper. You should be able to see daylight completely through the two holes.

4) Use the shortest of the three supplied aluminum tubes for the tank fuel feed tube. Use the longest of the supplied tubes for the tank vent tube. Carefully poke the aluminum tubes through the two open holes in the stopper assembly. Keep pushing the tubes in until 3/8" of tube sticks out in front of the stopper. PLAN AHEAD: The two aluminum tubes should end up horizontally opposed to each other at the top of the stopper.

5) Put the plain end of a #47 drill bit about 1/4" inside the back end of the vent tube. Using the drill bit for leverage, slowly bend the back end of the vent tube upwards at least 45°. Try not to put a kink in the aluminum tube.

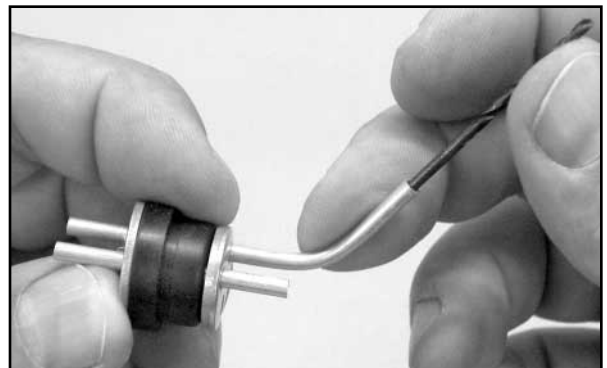

6) Test fit the completed stopper assembly into the neck of the fuel tank. Rotate the stopper so the aluminum tubes are horizontal at the bottom of the stopper. Hold the tank up to a strong light and look inside to see if the vent tube is close to the top of the tank. If not, adjust the bend in the vent tube as needed.

7) Take the stopper back out of the tank. Slide the piece of silicone tubing that came with the tank onto the inside end of the aluminum feed tube. Then add the metal clunk pickup to the other end of the silicone tubing. Test fit the stopper back in the tank to make sure the clunk can swing freely without hitting the back of the tank. If it hits the back end of the tank, shorten the silicone tubing in a small amount at a time until the clunk can swing freely inside the tank.

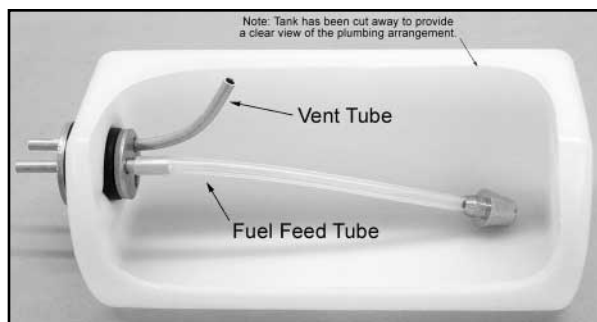

8) When everything is right, tighten the screw in the stopper cap until the cap is snug in the neck of the tank. Then test the fuel tank for leaks! Fill your kitchen sink with water. Slip a piece of fuel line tubing onto the tank vent tube. Submerge the tank in the water, holding your thumb firmly over the fuel feed tube. Blow air into the other end of the fuel tubing and watch for air bubbles coming around the cap of the tank. If it's leaking, tighten the screw in the cap a little at a time until the leaking stops.

9) Trial fit the tank in place inside the fuselage to familiarize yourself with how it mounts. The front of the tank should fit through the hole in the firewall. The main body of the tank is supported by the contoured hole in the fuselage former. Note: If your engine mounting bolts are protruding behind the firewall, it's a good idea to take them out and shorten them so they don't protrude. If they contact the tank, they might dig into the tank and cause a leak in the future. Cut them off or use shorter bolts.

10) Apply a generous bead of silicone sealer around the neck of the tank (regular household bathroom type silicone sealer, available at most hardware stores, is recommended). Slide the tank in place in the fuselage. Push the tank firmly up against the back side of the firewall, compressing the silicone sealer to make a good seal. If excess silicone sealer oozes out onto the front of the firewall, clean it off.



11) A 5/16" x 3/4" x 4-9/16" balsa stick is provided to keep the fuel tank in place. Install the balsa stick across the back of the tank, gluing it to the sides of the fuselage. This will keep the tank from sliding backwards in flight. If the tank ever has to be removed for service, you can break the balsa stick loose and get the tank out.

12) Cut two 6" lengths of silicone fuel tubing (not included), and install them on the two aluminum fuel tubes coming out of the firewall. Attach the fuel feed line to the engine's carburetor and the vent line to the pressure fitting on the muffler. (NOTE: Trim off any excess length of fuel line tubing. The fuel lines should be kept as short as possible for best fuel draw, but not so short that there is danger of them coming off in flight. Leave a little slack in the lines.)

#### FILLING THE FUEL TANK

To fill a fuel tank with this vent arrangement, first remove the fuel lines from the carburetor and the muffler pressure fitting. Pump the fuel into the tank through the fuel feed line (carb line). When the tank is full, fuel will begin to run out the vent line (muffler line). Stop pumping when you see the fuel start to come out the vent line! Re-connect the fuel lines and you are ready to start the engine.



13) When using a glow engine it is best to seal the bottom hatch to keep fuel and exhaust residue out of the fuselage. The reason we built a hatch into this airplane was to provide access to the battery compartment when using an electric motor. Obviously, you do not need access to that area. Simply glue the hatch in position, and then seal over the seams with either clear tape or the same color covering material.

#### COWLING

An opening needs to be made in the top of the cowling to clear the engine head and carburetor. Don't be tempted to quickly dive in with a knife and start removing large chunks of material. You will achieve a lot better result if you take the time to develop a pattern and mark it on the cowling for guidance when you are cutting.

1) Begin by marking a centerline on the top of the cowl, as shown.

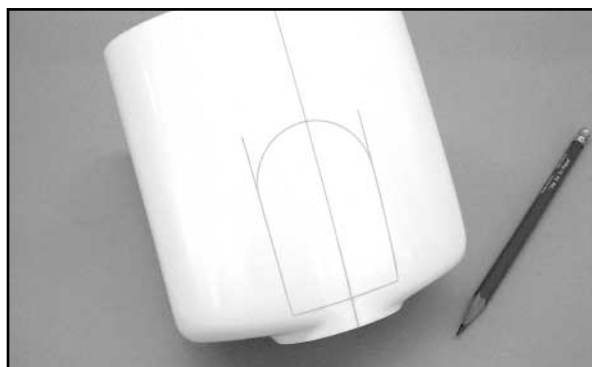

Then take width and length measurements off your engine and transfer them to the top of the cowl, using the centerline as the base reference point. The simple pattern shown in the previous photo was quickly made by measuring the diameter of the engine head and the overall length of the engine. It will serve as an undersize starting point for removal of material.

2) A Dremel® Tool, or similar powered hand-tool, with a 5/8" dia. coarse grit sanding drum is without a doubt the best tool to use for removing the material inside the lines quickly, easily and accurately. However, if you do not have access to such a power tool, you can cut the opening with a drill, a hobby knife, and a file - by first drilling a series of almost touching holes inside the pattern lines (1/8" dia. works well); then using the knife to cut through the connecting material between each hole; and finally finishing the edges of the opening with the file or a sanding block.

Be aware that there are no hard and fast "rules" for the exact perfect shape for openings in a cowling. Most important, make it big enough to provide the access you need to the engine. The best method is to "sneak up" on these openings, continually trial fitting the cowling over the engine until it finally fits properly. Once the opening is big enough for you to slip it over the engine and place it in correct location on the model, then continue modifying the opening as needed to provide access to the needle valve and the fuel line tubing at the carb.

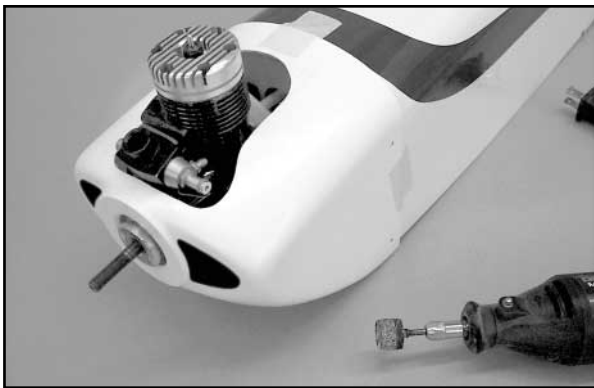

3) When satisfied with the opening in the cowling, mount the cowl to the fuselage with the four M2.6 x 10mm PWA Screws provided.

a) Start by placing the cowl over the engine and in correct position on the front of the fuselage.

b) Mount the 2" dia. spinner on the engine. Note that the spinner backplate may not fit tightly on the propeller shaft of your particular engine. Four different sizes of plastic adaptor rings are included with the spinner to "sleeve" the backplate. Try each ring until you find the one that fits your engine propeller shaft. It should fit smoothly with no play. Then fit the spinner backplate onto the prop shaft and over the adapter ring, all the way to the rear of the shaft, against the engine. To hold the backplate in place, mount a propeller on the shaft and hold it in place against the spinner backplate using the engine propeller washer and propeller nut.

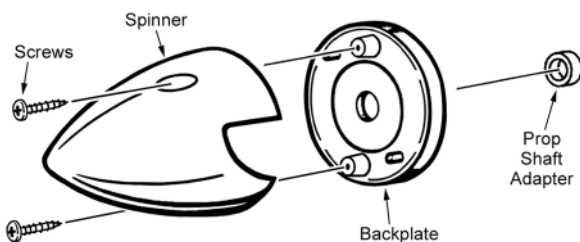

c) Move the cowling back into proper position on the fuselage, leaving a 3/32" to 1/8" gap between the front of the cowling and the back of the spinner, for clearance. Tape the cowling in correct position using a low-tack tape.

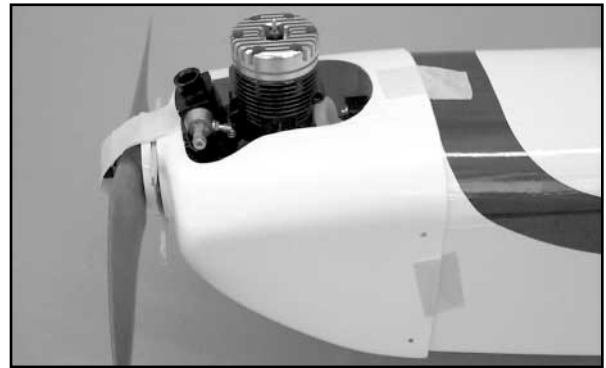

d) At the rear of the cowl there are four small pre-drilled mounting holes - two on each side of the airplane. Use a 1/16" drill bit to make a guide hole through one of the cowl mounting holes and into the fuselage side. Install an M2.6 x 10mm PWA Screw into the drilled hole and screw it in place - do not over-tighten the screw. Recheck the overall fit of the cowl and make any adjustments needed with tape to hold it in place. Then on the opposite side of the fuselage, drill another 1/16" guide hole and install a screw into that hole. Repeat this process for the remaining two cowl mounting holes. Remove the tape.

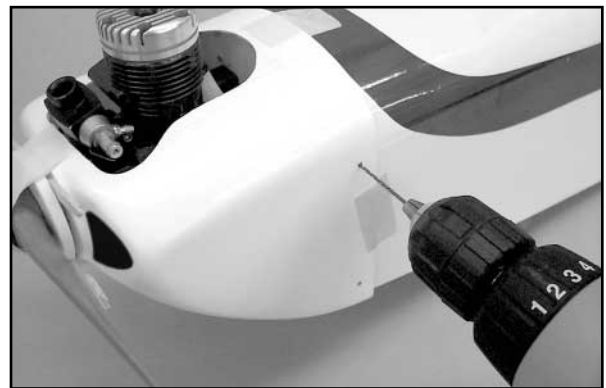

4) Remove the cowling and set it aside for now, while installing the throttle pushrod.

### THROTTLE PUSHROD

Locate the following parts from the kit contents:

- (1) Nylon Outer Pushrod Sleeve (already in the fuselage)
- (1) 1/8" od x 19-3/4" Nylon Inner Throttle Pushrod Tube
- (2) M2 x 7/8" Threaded Studs
- (3) Metal R/C Links

1) The first step is to install your throttle servo in the fuselage, using the rubber grommets, eyelets, and screws that came with the servo. Mount the servo in the front opening in the servo tray, lengthwise across the fuselage. The servo arm should be towards the right side of the airplane, as shown in the following picture.

2) The outer sleeve for the throttle pushrod is already installed in the fuselage, but not glued. Position the sleeve so the servo end is approximately 1/4" - 3/8" behind the fuselage former that is right in front of the throttle servo. Then glue the sleeve to the former.

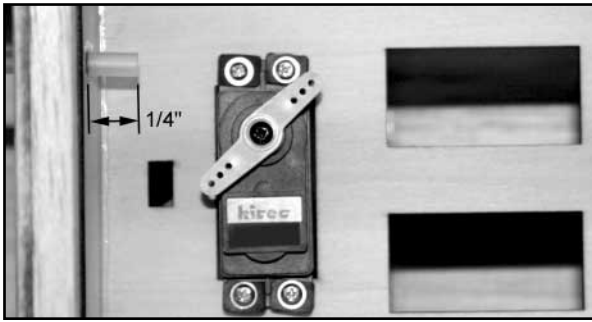

3) Cut off the front end of the sleeve approximately 1-1/2" away from the center of the throttle arm. Glue the sleeve to the firewall.

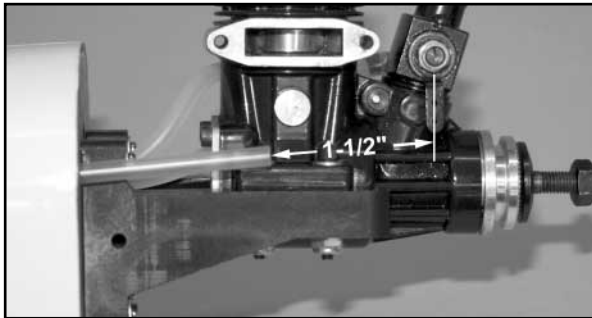

4) Screw an M2 x 7/8" threaded stud into one end of the 1/8" od x 19-3/4" nylon pushrod tube - thread it in at least 1/4" or more. Then screw a metal R/C link halfway onto the stud. NOTE: If the threaded stud screws into the plastic tube too easily, not getting a good "bite" in the plastic, put a little epoxy glue or medium CA on the threads and in the end of the tube before screwing it in.

5) From the front of the airplane, insert the unprepared end of the nylon pushrod tube inside the throttle pushrod sleeve and slide it all the way back. Snap the R/C link into the bottom hole in the engine throttle arm.



**NOTE:** Most 2-stroke R/C engine carburetors will provide low throttle when the throttle arm is pulled fully back toward the rear. Check your carburetor and confirm the correct direction of travel for "low" and "high" throttle movement and then check the throttle servo to be sure it also moves in the right direction.

6) a) Pull the carburetor throttle arm back to the full low throttle position and hold it in this position with a piece of tape.

b) Turn on the radio system - transmitter first and then the airborne system. Move the transmitter throttle stick to the full "low" throttle position, with the throttle trim lever centered.

c) In the fuselage, install an R/C link and threaded stud in the throttle servo arm. Position the throttle servo arm at about a 45°

back position.

d) Then use a marker pen to mark the nylon pushrod tube where it should be cut and still accept 1/4" of the threaded stud.

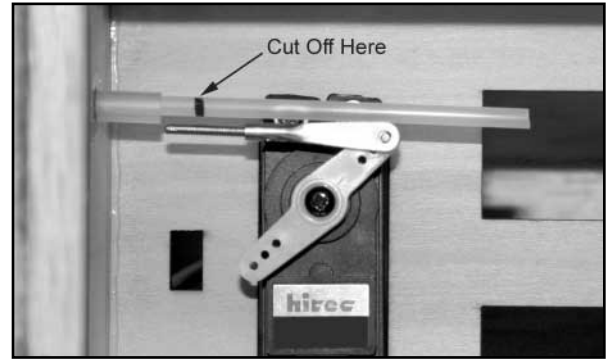

7) a) Remove the R/C link from the throttle arm, and then pull the throttle pushrod tube out of the sleeve. Use a razor blade to cut the pushrod tube at the mark made in the previous step.

b) Screw the M2 x 7/8" threaded stud into the servo end of the throttle pushrod tube.

c) Reinstall the pushrod back inside the sleeve. At the servo end, thread the R/C link back onto the threaded stud and then clip the link in the throttle servo arm.

d) At the engine end, clip the R/C link back in the throttle arm.

e) With the radio system turned on, test the operation of the throttle pushrod and carburetor. Make adjustments to one or both of the R/C links until you can achieve full range of throttle movement. Ideally, the range of moment you want is as follows:

STICK FORWARD  
TRIM FORWARD  
HIGH SPEED

STICK BACK  
TRIM FORWARD  
GOOD IDLE

STICK BACK  
TRIM BACK  
KILL ENGINE

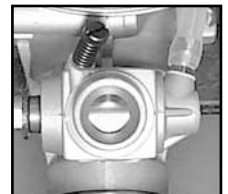
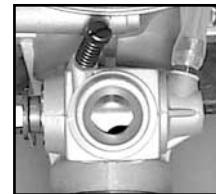
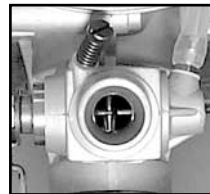

Use the EPA (End Point Adjustment) feature of your transmitter to accurately dial-in the desired servo travel. Also make sure there is no binding in the throttle linkage, which could cause unnecessary battery drain. Understand that the final throttle set-up will be done after the engine is broken-in and running.

*The installation of your glow engine is now completed. Skip the next section on electric motors and proceed directly to "Attaching The Tail Surfaces" on page 13.*

## ELECTRIC MOTOR INSTALLATION

If you are going to use an electric motor system in your KADET SENIOR, you will need to acquire these items (not supplied):

- (1) Electric Motor and suitable Propeller
- (1) Motor Mount
- (1) set of Mounting Bolts and Blind Nuts
- (1) ESC (Electronic Speed Control)
- (1) Battery Pack
- (1) set of Connectors (Battery-ESC)
- (1) 3/4" wide hook-and-loop sticky-back tape
- (1) 3/4" wide hook-and-loop strap

There are literally dozens of good electric motors and accessories on the market that are suitable for flying the KADET SENIOR. All of them have their own unique features and dimensions, making it impossible to write detailed instructions for every brand. As mentioned in the beginning of this manual, we will be installing a Maxx Products #HC3528-1000 brushless outrunner electric motor, with the Maxx Products #ACC3958 Motor Mount, and a Castle Creations ESC. Even if you use other brands, the following instructions should provide you with enough guidance to successfully install your electric power system.



**IMPORTANT NOTE ON MOTOR MOUNTS:** If you are using a different brand electric motor or motor mount, you need to make sure that the combination you select can provide exactly 4-1/2" distance from the front of the prop adaptor to the front of the firewall (i.e. back of the mount). 4-1/2" is the distance needed for the cowling to fit properly.

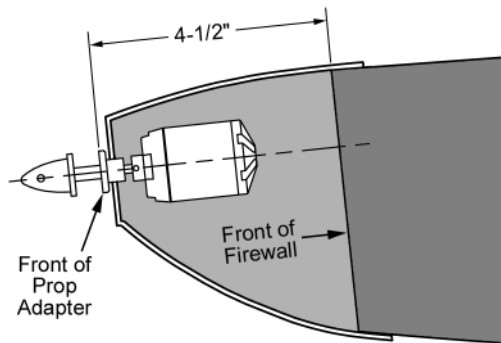

1) There are four sets of "cross-hairs" etched on the front of the plywood firewall to mark the locations of the mounting holes for the Maxx Products #ACC3958 Motor Mount. To install this mount on the firewall you will need to purchase (4) 4-40 x 1/2" Socket-Head Bolts, (4) #4 Flat Metal Washers, and (4) 4-40 Blind Nuts. Drill the four mounting holes with a 9/64" or #27 drill bit.

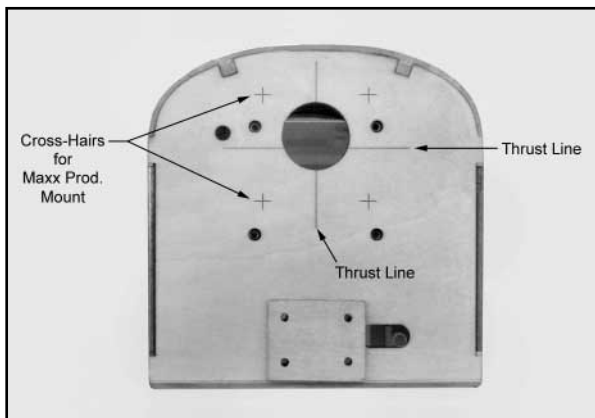

*NOTE: If you are using a different mount, line your mount up on the firewall according to the horizontal and vertical thrust lines that are etched in the plywood. Then drill appropriate holes where needed for your mounting bolts.*

2) Install the blind nuts on the back of the firewall. The best method is to use one of your mounting bolts, with a flat washer on it, from the front side of the firewall to "draw" the blind nut into the back side. Keep tightening the bolt until the prongs of the blind nut are completely locked into the plywood. After you get all four blind nuts in place, apply a little glue around the flanges of the blind nuts to keep them from coming loose. Be careful not to get any glue in the threads of the blind nuts.

*HELPFUL HINT: It's never easy putting a blind nut on the backside of the firewall of a pre-built model. Here's a handy trick! Take a stick of scrap balsa wood - 1/4" sq. x 10"-12" long works well in most cases - and put a piece of doubled-up tape on the end, and then stick the blind nut to the tape. With this stick you can reach inside the nose of the airplane and hold the blind nut in position while you screw in the mounting bolt from the front of the firewall. If the model structure doesn't allow a straight shot at the location, cut an angle on the end of the stick to allow you to hold the blind nut at the correct angle.*

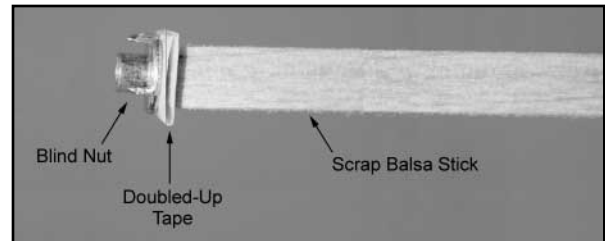

3) Additional holes are needed in the firewall to allow air to flow back inside the fuselage to cool the battery and the ESC in flight. We recommend drilling eight 3/8" dia. holes in the locations shown in this photo. Measure the locations of the holes off the vertical and horizontal thrust lines that are etched in the firewall.

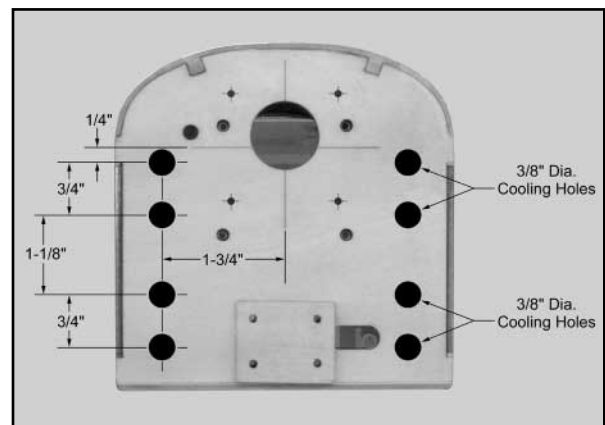

4) Bolt your motor and mount to the firewall. Use thread lock compound (not supplied) on all the bolt threads.

5) Solder the appropriate connectors (not supplied) to the battery leads of your ESC.

6) Mount your ESC inside the nose just behind the firewall, sticking it to the fuselage side with a 1-1/2" long piece of 3/4" wide "hook & loop" tape (not supplied).

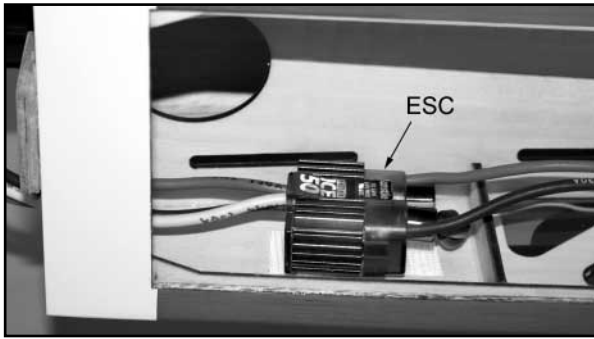

7) Pass the motor leads from the ESC through one of the cooling holes you made in Step 3. Connect the leads to your motor. Use the radio system to operate the motor and check the direction of rotation. If you need to reverse the rotation, refer to instructions that came with the motor and ESC.



8) Put a strip of 3/4" wide hook-and-loop tape (not supplied) on the battery compartment floor. Put a strip of the mating tape on each of your battery packs. This will keep your battery pack from shifting position in flight.

*Note: Hook-and-loop "tape" has either the hook or the loop on only one side of the strip. The other side is sticky back.*

9) Cut two 9" long pieces of 3/4" wide hook-and-loop strap material (not supplied). Install the two straps in the battery compartment as shown, running them through the slots in the plywood floor. Anchor the straps to the backside of the plywood with a few drops of glue. These straps will keep your battery pack from falling out of the airplane.

*NOTE: Hook-and-loop "strap" has the hook surface on one side of the strip and the loop surface on the other side. You can overlap the ends of the strip and stick them together, effectively creating a strap to hold your battery pack securely in position.*

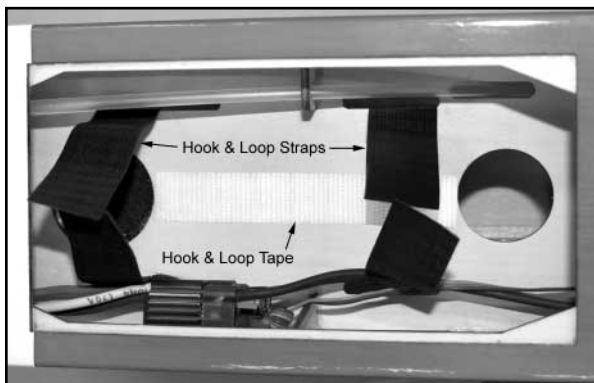

10) Mount the cowling to the fuselage with the four M2.6 x 10mm PWA Screws provided. Note that four holes for the screws are already in the cowling - two on each side. Tape the cowling in correct position on the fuselage, using a low-tack tape. Use a 1/16" drill bit to make a guide hole through one of the upper cowl mounting holes and into the fuselage side. Install an M2.6 x 10mm PWA Screw into the drilled hole and screw it in place - do not over-tighten the screw. Recheck the overall fit of the cowl and make any adjustments needed with tape to hold it in place. Then on the opposite side of the fuselage, drill another 1/16" guide hole and install a screw into that hole. Repeat this process for the remaining two cowl mounting holes. Remove the tape.

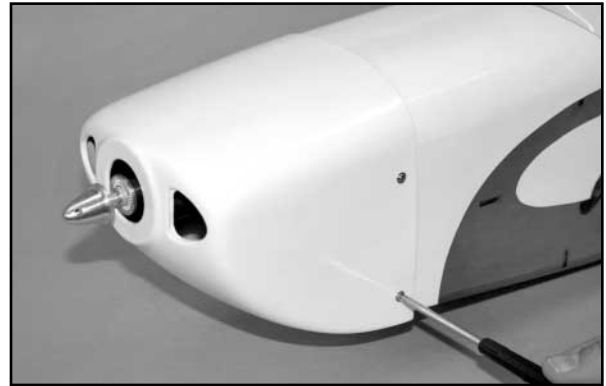

11) **OPTIONAL SPINNER:** A 2" dia. spinner is included in this kit. No doubt it will be used by almost everyone who is installing a glow engine. However with an electric motor you may prefer to not use the spinner in order to allow more cooling air to flow into the cowling. The opening between the prop shaft and the cowling (which a spinner would cover up) allows a significant amount of air to flow in directly onto the motor, to keep it running cool.

Nonetheless, many people do successfully use big spinners on fully cowled electric motors. If you do decide to use a spinner, you will need to make some additional openings in the front of the cowling for cooling air to enter. Also make sure you have plenty of exit area for the air. In any fully cowled installation (glow or electric), it is critical that you have slightly more exit area than incoming area. Having more exit area creates a positive air flow through the cowling - an actual suction effect - drawing the heated air out of the cowling so that more cool air can come in.

## ATTACH THE TAIL SURFACES

*Both glow engine and electric motor users resume assembly here.*

1) Trial fit the stabilizer/elevator assembly on the fuselage, without glue. Use a couple pins to hold it in position. Use a tape measure or yardstick to measure the distance from the rear corner of the stab to the rear edge of the wing saddle. Then, take the same measurement on the other side of the fuselage. The two measurements should be identical or within 1/8" of each other. If not, unpin the stabilizer and shift it as needed to get the two measurements the same. Once you have it squared up, use a fine felt time marker to give yourself some guide marks at the front and back of the stab, so you can quickly realign it later when glue is applied.

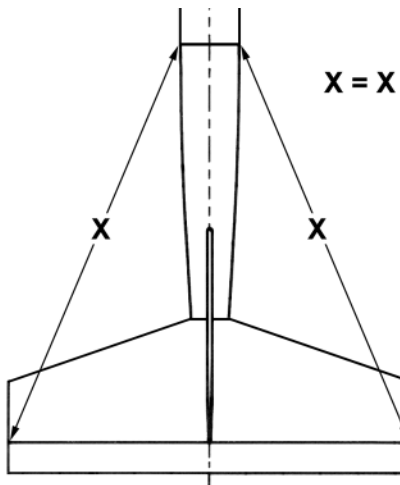

Also check the alignment of the stabilizer from the front view. Mount the wing to the fuselage, using the two 1/4-20 x 1-1/2" nylon wing bolts provided. Place the model on a flat surface and orient it to allow you to view the airplane from the front from a distance of 10 feet or so. With the stabilizer squarely in place and pinned, view the airplane from the front and rear. The stabilizer should be equally aligned with the wing - not tilting one way or the other. If it is tilting, correct it.

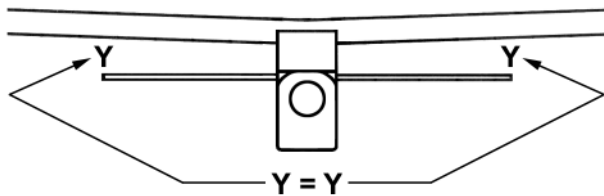

When satisfied with the alignment, remove the stabilizer from the fuselage in preparation for gluing on permanently.

2) We recommend gluing the stabilizer permanently onto the fuselage with slow-drying epoxy glue, which will provide plenty of time to get the stabilizer properly realigned with the fuselage and wing. Mix a batch of epoxy in sufficient quantity to cover the area of the fuselage where the stabilizer goes. Spread the glue evenly over the exposed wood of the stabilizer saddle. Carefully set the stabilizer back in position on the saddle. Press the stabilizer down firmly and pin it in correct position. Quickly recheck the alignment in both the top and front views before the glue dries. Use a paper towel and rubbing alcohol to wipe off any excess glue that oozes out of the joint. Let this joint dry completely before proceeding.

3) Trial fit the fin/rudder assembly on the fuselage, without glue. Hold the fin in place and use a sharp pencil to trace around its edges, where it contacts the top of the fuselage. Remove the fin and use a sharp hobby knife to cut and remove the covering from just inside of the pencil marks just made.

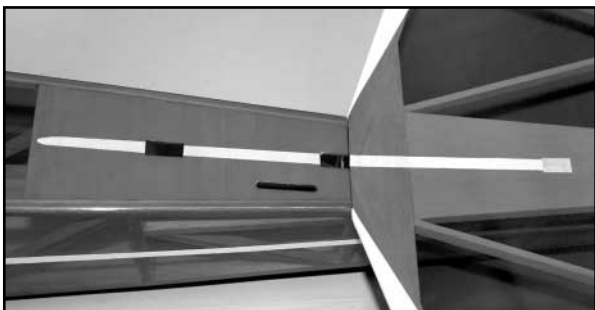

4) Use a very sharp blade (single-edge razor blade shown) to slice off any excess covering material on the bottom of the fin, in order to maximize the gluing area where it mates to the stab and fuselage.

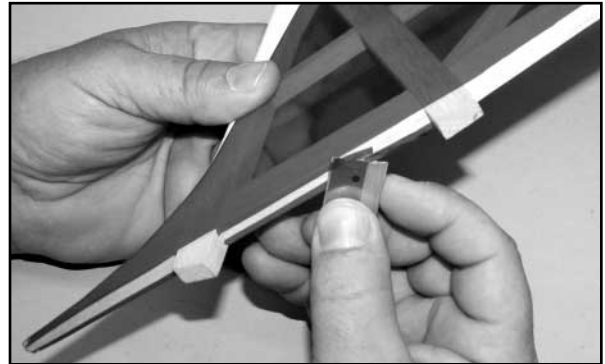

5) Apply epoxy glue to the bottom of the fin, including the tabs that fit into the slots in the stabilizer and fuselage. Press the fin/rudder assembly in place. Use masking tape to hold the fin in correct position. Double check the alignment of the fin - it should be perpendicular (90°) to the stabilizer. Adjust the tape as needed to hold it in position. Use alcohol and a paper towel to wipe off any excess glue. Allow the glue to dry completely before proceeding.

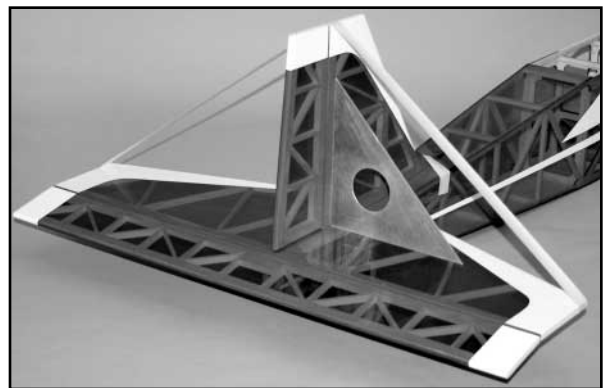

## RADIO INSTALLATION

The aileron servos and the throttle servo (glow only) are already installed and ready to use. The rest of the radio installation consists of mounting the elevator and rudder servos in the fuselage, along with the receiver, battery pack, and switch.

### 1) ON/OFF SWITCH

The switch can be mounted in any position provided its leads can reach the receiver and battery pack.

**Internal Mount:** There mounting location for the switch provided at the front of the plywood servo tray built into the fuselage. Installing the switch in this location keeps it inside of the fuselage and away from dirt and fuel. If you wish to mount your switch in this location, you will need to bend and install a push/pull wire that extends out of the fuselage side. To do this, just drill a 1/16" dia. hole through the top of the switch lever and use a piece of 1/16" dia. music wire to activate the switch, as shown in the photo.

**External Mount:** The switch can also be mounted directly into the side of the fuselage, using the hardware and plastic parts that are included by the radio manufacturer. Typically, an externally mounted switch is placed on the left side of the fuselage. Start by

using the switch cover plate as a template to mark the location of the two mounting holes and the opening needed for the switch to operate. Be sure there is solid sheet balsa under the covering in the area you are putting the switch. Use a modeling knife to cut the opening. Use a 1/16" dia. drill to make the holes for the bolts. Install the switch.

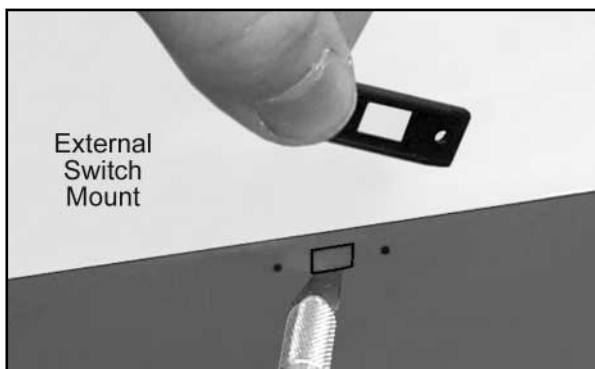
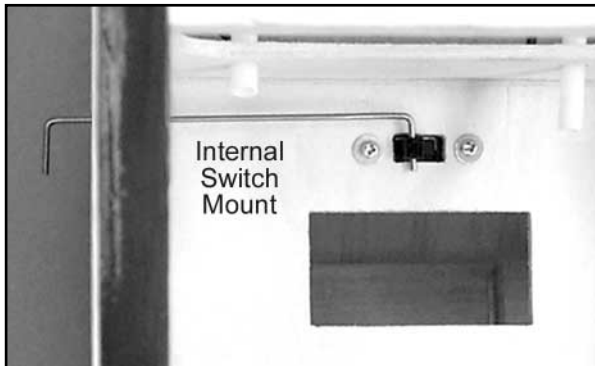

## 2) ELEVATOR & RUDDER SERVOS

Mount the elevator and rudder servos in the plywood servo tray using the screws and rubber grommets that came with your radio system. The elevator servo should be mounted in the right rear opening of the servo tray. The rudder servo should be mounted in the left rear opening. Be sure to drill pilot holes in the plywood servo tray before trying to screw the servo in place.

## 3) RECEIVER

a) Drill a 1/16" dia. hole completely through the bottom of the fuselage, just ahead of the middle cabin former. This hole is for the receiver antenna to exit the fuselage. Put a single drop of thin CA on the hole to harden the edges and keep the covering from coming loose. Let the CA dry completely, then run your drill bit by hand through the hole again to tidy up the edges.

*NOTE: These instructions describe running the antenna outside along the bottom of the fuselage. There are a lot of other ways to handle the routing of a receiver antenna, such as mounting it in a tube (not supplied) you mount inside the fuselage. If you prefer a different method, by all means use it.*

b) Following the radio manufacturer's instructions, plug all the wires for the servos, battery pack, and switch harness into the receiver so the radio system is fully operational. Double check to be sure that each servo is plugged into its correct receiver terminal and that it is responding properly.

c) Wrap the receiver in a single layer of 1/2" thick soft foam rubber to insulate it from vibration and shock. Use tape or rubber bands to hold the foam around the receiver. Stuff the receiver directly beneath the servo tray and use additional foam, or a plastic "cinch" strap, to hold it in place.

d) Poke the receiver antenna wire down through the 1/16" hole you made in the bottom of the fuselage (use an "antenna strain relief" fitting if one came with your radio). Make sure the antenna wire is not tangled up in the servo and battery wires! Continue pulling the antenna out of the fuselage and towards the rear of the airplane.

e) Anchor the antenna to the bottom of the fuselage with tape, or with a small rubber band and a T-Pin (not supplied). We prefer the rubber band and T-Pin method, as shown in the next photo.

Stick the T-Pin into one of the wood cross-pieces in the bottom of the fuselage (pick a cross-piece that is a couple inches past the end of the stretched out antenna wire). Don't push the pin all the way in - leave it sticking out about 1/8" or so. Put a drop or two of CA glue on the pin to keep it in place. Loop the rubber band onto the end of the antenna wire. Then loop the other end of the rubber band over the T-Pin. If the antenna hangs loose, move the rubber band forward on the antenna wire.

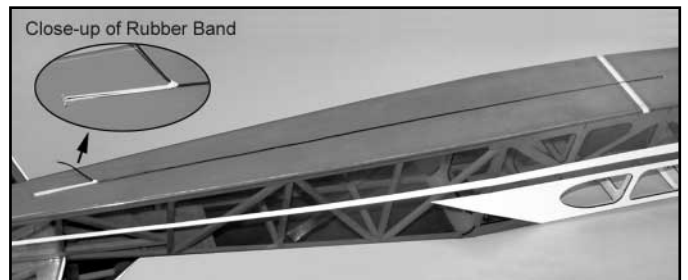

## 4) RECEIVER BATTERY PACK

a) If you are using a receiver battery pack (all glow and some non-BEC electric motor installations) wrap the battery pack with a single layer of 1/2" thick soft foam rubber to insulate it from vibration and shock. Use tape or rubber bands to hold the foam around the battery.

b) For now, leave the receiver battery pack loose on the bottom of the fuselage in front of the servos. Later, when the Center of Gravity (CG) is established, the final position of the battery pack will be determined.

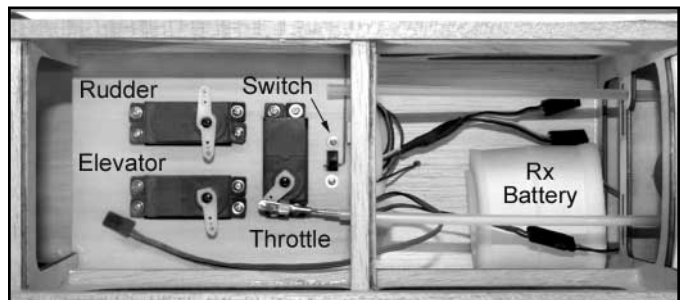

## ELEVATOR & RUDDER PUSHRODS

Locate the following parts from the kit contents:

- (1) 3/8" dia. x 22" long Wood Rudder Pushrod
- (1) 3/8" dia. x 33-1/2" long Wood Elevator Pushrod
- (1) 1/8" od x 19-3/4" Nylon Nose Gear Inner Pushrod Tube
- (3) Metal R/C Links; elev(1), rudd(1), nose gear(1)
- (4) Heat Shrink Tubing
- (2) 2mm x 4" long Pushrod Wires; threaded on one end with "Z-bend" on other end; for rud & elev (servo end)
- (2) 2mm x 11-3/4" long Pushrod Wires; threaded on one end; for rud & elev (tail end)



- (1) 2mm x 1-5/8" long Pushrod Wire; threaded on one end, with "Z-bend" on other end; for nose gear
- (1) M2 x 7/8" Threaded Stud; nose gear pushrod (servo end)
- (2) Nylon Control Horns; for elevator and rudder
- (2) Nylon Control Horn Bases
- (4) M2 x 20mm Mounting Bolts; for rud & elev control horns

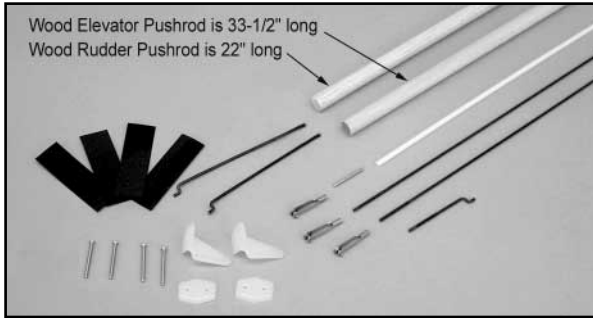

- 1) Mount a nylon control horn on the bottom of the elevator with two M2 x 20mm bolts and a nylon control horn base.
  - a) Start by holding the control horn in place on the bottom of the elevator. Make sure it is aligned with the center of the opening at the very rear of the fuselage, and that it is all the way forward so that the holes in the arm line up with the hinge line. Use a pencil or pointed tool to mark the location of the two mounting holes onto the elevator.
  - b) Drill a 1/16" dia. hole at both of the marks, all the way through the elevator.
  - c) Poke two M2 x 20mm bolts through the control horn, and then press or screw the assembly on the bottom of the elevator.
  - d) As the bolts come through the top of the elevator, engage the bolt ends into the holes in the nylon control horn base. Tighten the bolts until the horn and the base are both up against the elevator. Do not over-tighten and crush the wood.
  - e) Use diagonal cutting pliers to trim-off the excess exposed ends of the bolts.

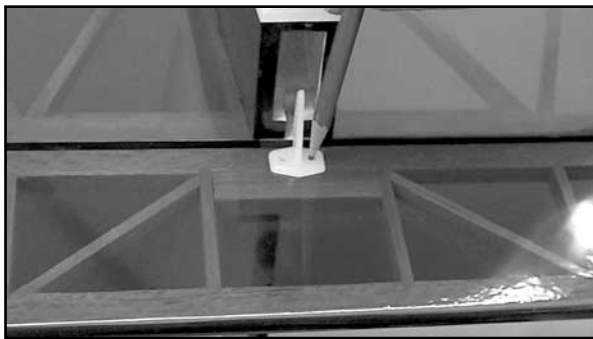

- 2) Mount a nylon control horn on the left side of the rudder with two M2 x 20mm bolts and a nylon control horn base, using the same techniques you did in the previous step for the elevator horn.

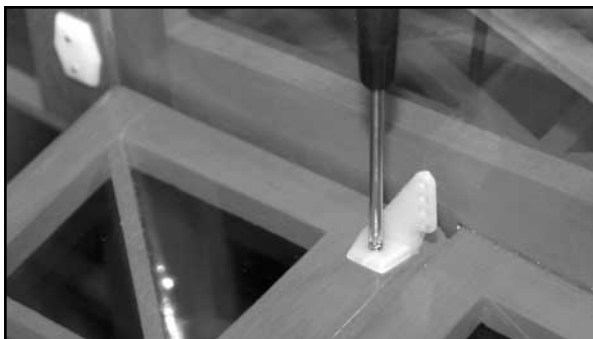

- 3) The front ends of both the elevator and rudder pushrods, where they connect to the servos, are identical. Repeat each of the following steps 2a-2f to assemble the servo end of both pushrods.
  - a) Start by using a ruler to measure and mark a point 1" in from one end of both 3/8" dia. wood pushrods.

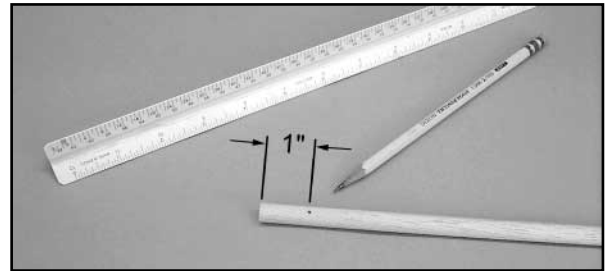

- b) Use a 5/64" drill bit to drill a hole all the way through the pushrod at the mark just made.

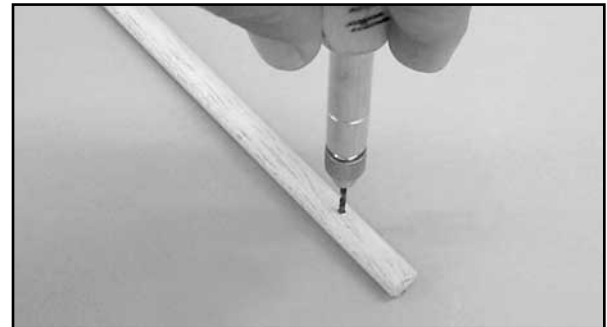

- c) Use a single-edge razor blade or hobby knife to make a 3/32" wide x 3/32" deep "channel", from the hole to the end of the pushrod. This channel is for the metal pushrod wire.

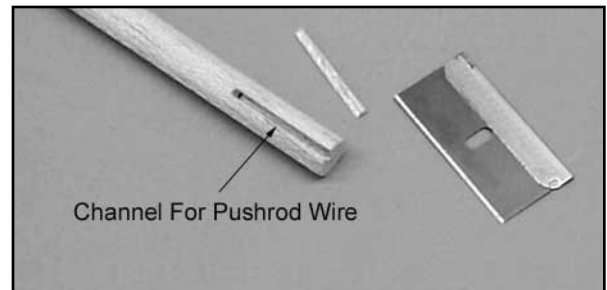

- d) Prepare a 2mm x 4" long pushrod wire for mounting in the channel. Use a ruler to measure exactly 3" back from the z-bend. At this mark, use pliers to bend the wire downward 90°, inline with the z-bend. Use diagonal cutters to trim the bent end, leaving 3/8".

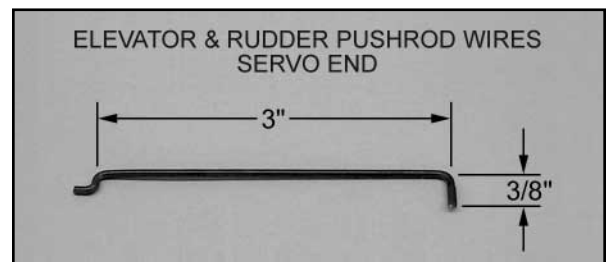

- e) Mix a small amount of 5-minute epoxy. Apply the glue in the channel and in the hole in the pushrod. Also apply epoxy to the 90° bent end of the wire pushrod. Insert this end into the hole and channel, pressing it firmly in place. Wipe off any excess glue and allow the glue to set.

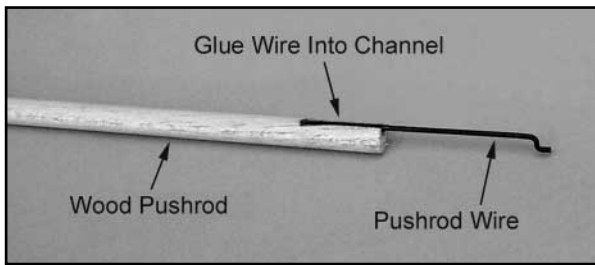

f) Slip a piece of heat shrink tubing over the glued wire and pushrod. Leave about 1/16" of the heat shrink tubing hanging over the end of the wood pushrod. Use a heat gun to shrink the tubing tight.

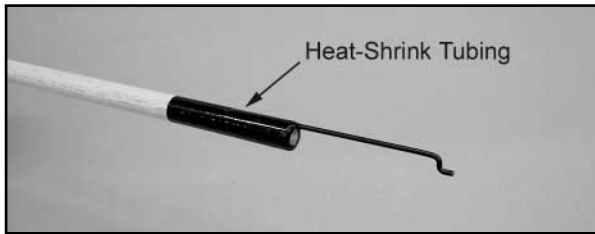

4) With the servo ends of both the elevator and rudder pushrods completed, the opposite ends are now assembled. This is where the two pushrods become different. In this step, we will complete the ELEVATOR PUSHROD and install it in the airplane.

a) Begin by cutting a 2mm x 11-3/4" long metal pushrod to a total length of 3-3/4". Cut the excess off the unthreaded end of the wire - not the threaded end! Then at the unthreaded end, measure and bend 3/8" of the wire to a 90° angle, as shown.

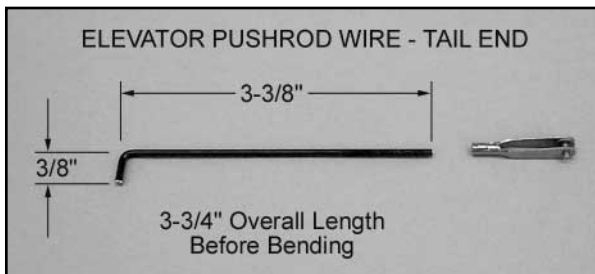

b) At the tail end of the wood elevator pushrod, measure and mark a point 1-1/8" from the end. Drill a 5/64" dia. hole completely through the pushrod at this point. Make this hole parallel with the hole drilled earlier at the other end of the pushrod.

c) After drilling the hole, again use a single edge razor blade to cut a 3/32" channel from the hole to the end of the pushrod. As before, this channel should be about 3/32" deep.

d) Epoxy the pushrod wire in place and allow the glue to dry.

e) Slide a piece of heat shrink tubing in place over the glued wire and pushrod, leaving about 1/16" of its length hanging over the end of the wood dowel. Use a heat gun to shrink the tubing tight.

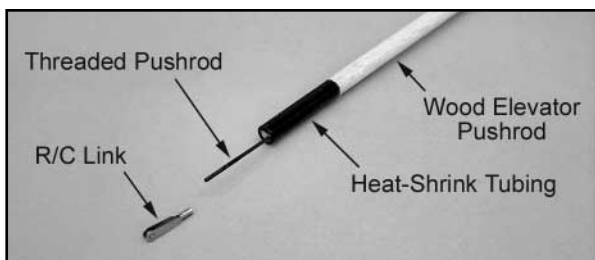

f) The elevator pushrod is ready to be installed in the airplane. Thread a metal R/C link onto the threaded pushrod wire, about

halfway up the threads. Insert the pushrod (z-bend end first) into the opening at the rear of the fuselage, and slide it forward until you can clip the R/C link into the bottom hole of the nylon elevator control horn.



g) Turn on your radio system and make sure the elevator trim is centered. Then check to see that the elevator servo arm is also centered, at 90° to the servo. If not, reposition the servo arm.

h) Now remove the servo arm and install it on the z-bend at the end of the elevator pushrod. Press the arm back onto the servo in the correct 90° position.

i) With the elevator servo at neutral, check position of the elevator itself. If not level, adjust the overall length of the elevator pushrod until it is. This can be done by lifting the arm off the servo and rotating the entire pushrod on the threads of the R/C link, thus adjusting its length as needed.

j) After adjusting the length of the elevator pushrod, press the servo arm back in place on the elevator servo. Don't forget to put the screw back in the servo arm, so the arm can't come off in flight. Turn off the radio system.

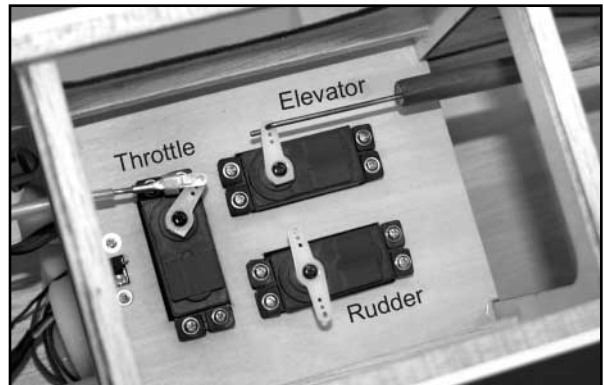

5) Next, we will complete the RUDDER PUSHROD and install it in the airplane.

a) Begin by cutting a 2mm x 11-3/4" long metal pushrod to a total length of 11-7/16". Cut the excess off the unthreaded end of the wire - not the threaded end! Then at the unthreaded end, measure and bend 3/8" of the wire to a 90° angle, as shown.

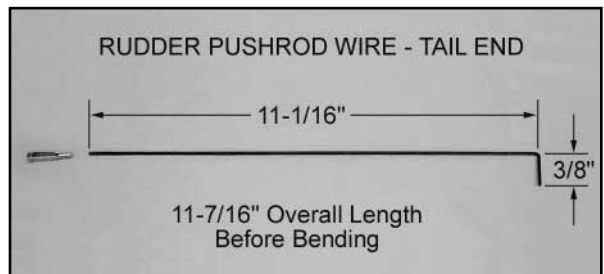

b) At the tail end of the wood rudder pushrod, measure and mark a point 1-3/4" from the end. Drill a 5/64" dia. hole completely through the pushrod at this point. Make this hole parallel with the hole drilled earlier at the other end of the pushrod.

c) Use a single edge razor blade to cut a 3/32" wide x 3/32" deep channel from the hole to the end of the pushrod.



d) Epoxy the pushrod wire in the channel and allow to dry.

e) Slide a piece of heat shrink tubing in place over the glued wire and pushrod, leaving about 1/16" of its length hanging over the end of the wood dowel. Use a heat gun to shrink the tubing tight.

f) The rudder pushrod is ready to be installed in the airplane. Feed the pushrod (threaded end first) into the fuselage through the cabin area. Watch for the threaded end of the pushrod to reach the slot on the top left of the fuselage, just ahead of the stabilizer. When it reaches the slot, reach in the slot with a small flat blade screwdriver to guide the threaded end of the wire up and through the slot.

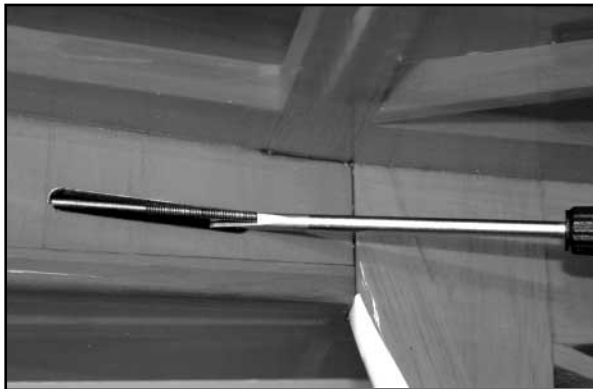

g) Thread a metal R/C link onto the pushrod wire, about halfway up the threads. Clip the R/C link into the 3rd hole of the nylon rudder control horn.

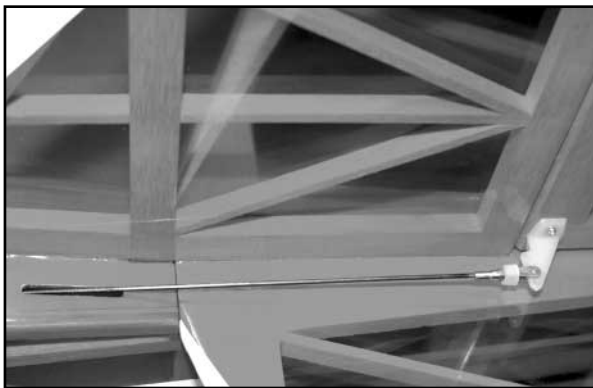

h) Turn on your radio system and make sure the rudder trim is centered. Remove the rudder servo arm and install it on the z-bend at the end of the rudder pushrod. Press the arm back onto the servo in the correct neutral position, at 90° to the servo.

j) With the rudder servo at neutral, check the position of the rudder itself. If not straight with the fin, adjust the overall length of the rudder pushrod until it is. This can be done by lifting the arm off the servo and rotating the entire pushrod on the threads of the R/C link, thus adjusting its length as needed.

k) After adjusting the length of the rudder pushrod, test the action of the rudder with the transmitter. It should be smooth with

no binding. Also make sure that the rudder is traveling in the correct direction! When satisfied, turn off the radio system.

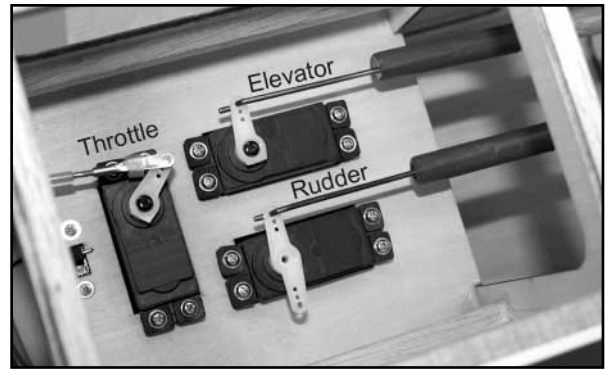

## NOSE GEAR

Locate the following parts from the kit contents:

- (1) Formed Nose Gear Wire (4mm dia. wire)
- (1) 3-3/8" Dia. Wheel
- (1) Nylon Nose Gear Steering Bracket
- (1) Nylon Nose Gear Steering Arm with Set Screw
- (4) M3 x 18mm Mounting Bolts
- (4) M3 Flat Washers
- (1) Plastic Wheel Spacer (4mm I.D.)
- (1) Wheel Collar with Set Screw (4mm I.D.)
- (1) 1/8" O.D. x 19-3/4" Nylon Inner Pushrod Tube
- (1) 2mm x 1-5/8" Pushrod Wire; threaded on one end, with "Z-bend" on other end
- (1) M2 x 7/8" Threaded Stud
- (1) Metal R/C Link

1) Install the plastic wheel spacer, the wheel, and the wheel collar on the axle of the nose gear wire (double check to make sure you have the 4mm I.D. spacer and collar - not the larger ones that go on the main landing gear). Make sure the wheel turns freely after you tighten the wheel collar.

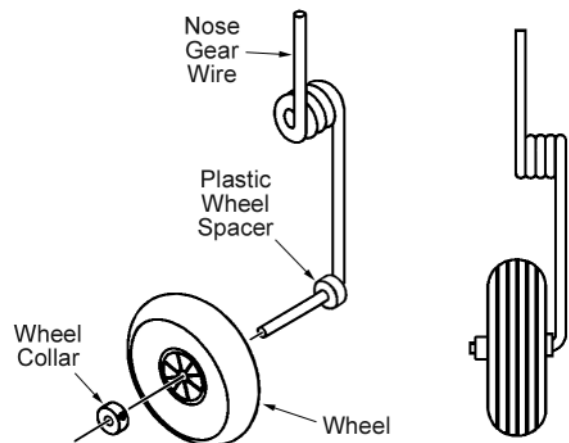

2) Bolt the nylon nose gear steering bracket in place on the firewall with the M3 x 18mm mounting bolts and flat washers provided. Note that M3 blind nuts are pre-mounted in the back of the firewall for the nose gear bracket. Use a little thread locking compound on the bolt threads to keep them firmly in place.



3) a) Drill out the last hole in the nylon steering arm so it will accept the Z-bend of the 2mm x 1-5/8" pushrod wire. Use a #49 (.073"), a 5/64", or a 2mm drill bit.

b) Thread the 2mm x 1-5/8" formed pushrod wire into one end of the 1/8" O.D. x 19-3/4" nylon pushrod tube. Screw it in as far as you can - approx. 3/4". NOTE: If the wire screws into the plastic very easily, put a little epoxy glue or medium CA on the threads and in the end of the tube before screwing it in.

c) Install the "Z-bend" end of the pushrod wire into the steering arm. Notice in the following photo that the steering arm has a bottom and a top - the arm is closer to the top. Install the z-bend in the arm from the bottom.

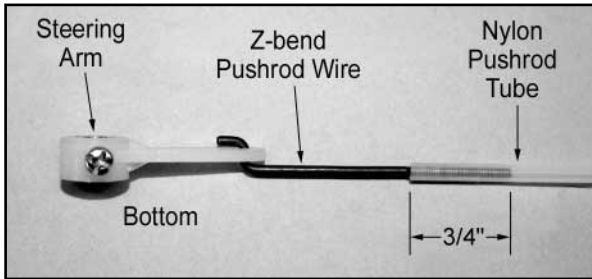

4) The outer sleeve for the nose gear pushrod is already installed in the fuselage, but not glued. Position the sleeve so the front end sticks out in front of the firewall about 1/8". Mark and cut off the servo end about 1-3/4" aft of the fuselage former in front of the servos. Secure the sleeve by gluing it to the two formers that it passes through inside the fuselage.

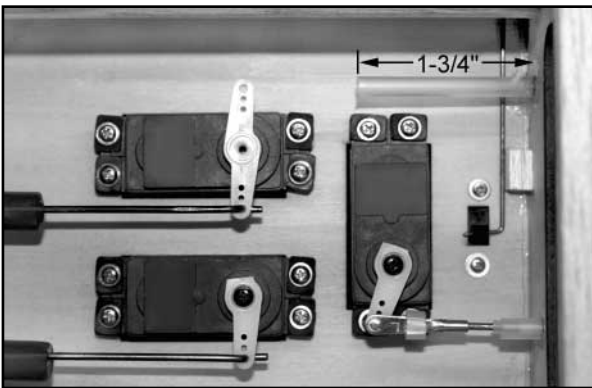

5) a) From the front of the airplane, insert the plain end of the nose gear pushrod inside the outer sleeve and slide it all the way back.

b) Hold the steering arm in position in the center opening of the nose gear bracket while you insert the nose gear wire up through the holes in the bracket and steering arm. Push the wire in until the top of wire is flush with the top of the steering bracket.

c) Snug up the set screw in the steering arm just enough to get a slight grip on the nose gear wire (keep it loose enough that you can adjust the steering arm position in the next step).



6) Align the nose wheel so it points straight ahead. Adjust the steering arm position on the nose gear wire so that the outer hole in the arm is about 7/8" away from the front of the firewall when the wheel is pointed straight ahead.

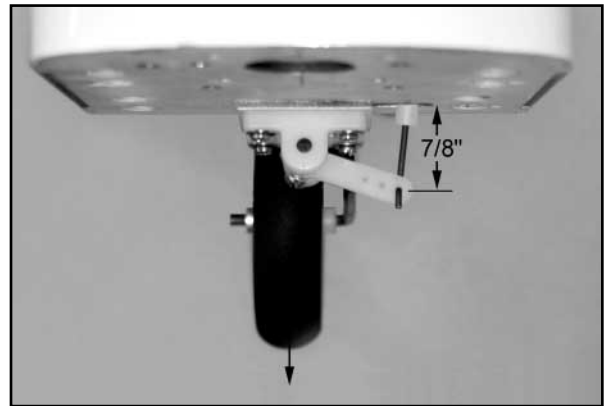

7) Use a marker pen to mark the location of the set screw on the nose gear wire. Remove the wire and file or grind a flat spot in the wire for the set screw to rest in. Then reassemble the parts, tightening the set screw securely. The flat spot will help insure that your nose gear steering doesn't slip.

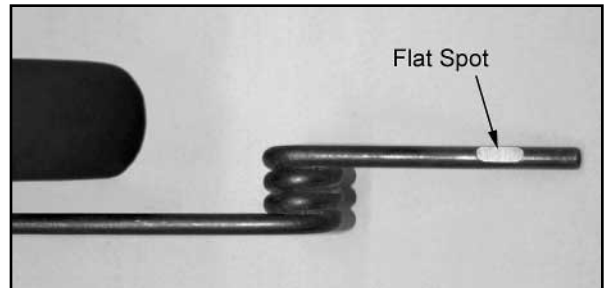

8) Test the action of the nose gear steering by moving the servo end of the pushrod by hand. It should be smooth and free. If there is any binding, fix it before proceeding.

9) a) Screw a metal R/C link onto the remaining M2 x 7/8" threaded stud.

b) Clip the R/C link into the outermost hole of the rudder servo arm, on the side opposite the rudder pushrod.

c) Make sure the rudder servo is centered and the nose wheel is pointing straight ahead, and then mark the nylon pushrod tube where it needs to be cut to accept 1/4"-5/16" of the threaded stud.

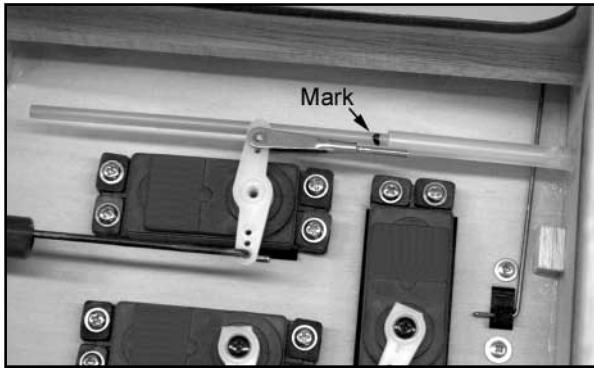

d) Take the R/C link and stud off the servo arm and screw the stud into the pushrod tube. NOTE: It's easier to do this if you remove the steering arm so you can take the pushrod out of the sleeve. That makes it easier to screw the threaded stud (alone, without the R/C link attached) into the servo end of the pushrod tube. When done, put everything back together and re-attach the R/C link. Make sure everything is tight, and that you've got all the servo arm screws installed.

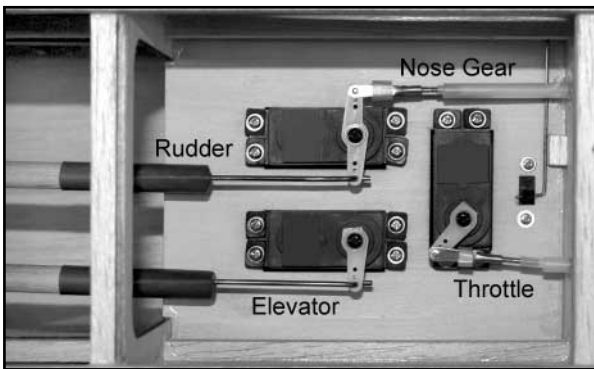

10) Turn on your radio and test the action of the steerable nose gear. It should be smooth and free of any binding. You can refer ahead in this manual to the section on "Control Surface Travel" and adjust the rudder and nose wheel travel now.

*NOTE: The exact amount of nose wheel travel is not as critical as the other flight control surfaces will be. A good rule of thumb, especially for new pilots, is that less travel of the nose wheel is better than more! You do not need any more than 10°-15° travel each way.*

## MAIN LANDING GEAR

Locate the following parts from the kit contents:

- (2) 5mm dia. Main Landing Gear Wires
- (2) 3-1/2" Dia. Wheels
- (2) Nylon Landing Gear Retaining Straps
- (4) M2.5 x 16mm PWA Screws
- (2) Plastic Wheel Spacers (5mm I.D.)
- (2) Wheel Collars with Set Screws (5mm I.D.)

1) Press the two 4.5mm plastic wheel spacers onto the two axles of the main landing gear wires. These are pressed all the way in place back to the bend. Note that these spacers are meant to be a tight fit. If necessary, use sandpaper to remove any burrs from the axle ends and, if needed, use a pliers to rotate the spacers onto the axles.

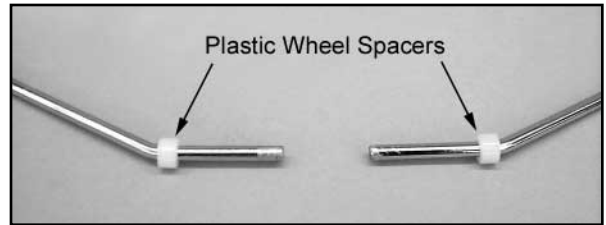

2) Install a 3-1/2" dia. wheel on the axle and slide it up against the plastic spacer. Then install a wheel collar and tighten the set screw. Make sure the wheel turns freely. Repeat the process to mount a wheel on the other main gear wire.

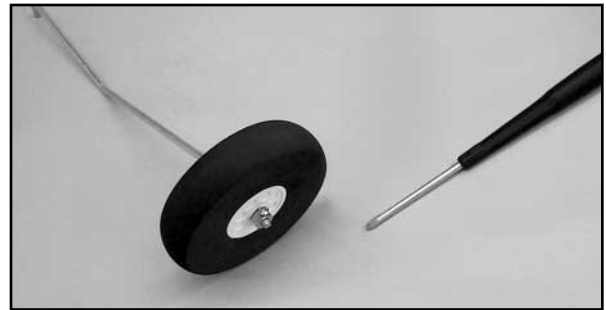

3) Turn the fuselage upside down on a padded work surface for installing the main landing gear. If your receiver antenna is over the landing gear slot, remove the rubber band holding it in place and move it out of the way temporarily. Fit the two main landing gear wires into the holes and slot in the bottom of the fuselage.

*NOTE: If you are doing a glow powered installation, be sure to fuel proof the bare wood in the landing gear slot in the fuselage. Use fuel proof paint, or simply flow thin CA glue onto the bare wood and let it dry thoroughly before installing the landing gear wires.*

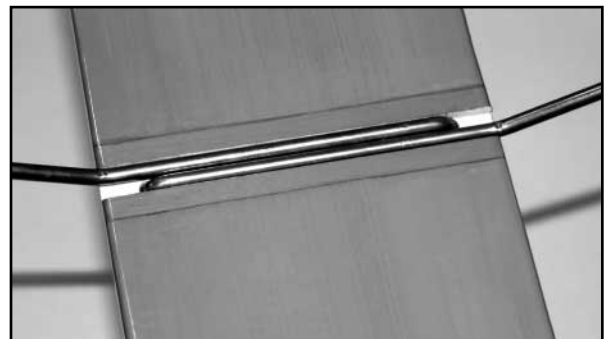

4) Place the two nylon landing gear retaining straps over the main gear wires as shown in the picture. Mark, then drill four 1/16" dia. pilot holes for the screws. Use four M2.5 x 16mm PWA Screws to mount the straps.

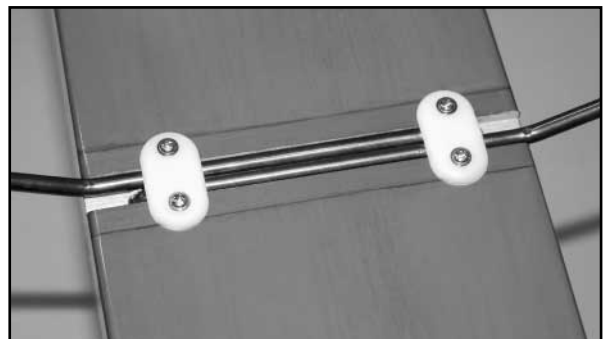

## INSTALL SIDE WINDOWS

From the kit contents, locate the bag containing the molded clear plastic side windows. These windows are molded to fit into the fuselage window frames from the inside. Note that each window has a ledge all the way around the outside perimeter to provide a easy gluing surface.

Glue the windows in place with 5-minute epoxy or RC-56 type glue. **Do not** use thin CA glue because it can cloud the plastic. Apply a thin bead of glue around the edge of the window and press the window in place from the inside of the fuselage. Don't use too much glue or it may ooze out onto the outside surface of the window. Use a few small pieces of masking tape to hold the window in place until the glue dries.



## DECAL APPLICATION

The decals supplied in your kit are sticky-back with a very aggressive adhesive. They are **NOT** water-activated. These decals are not die-cut and need to be cut from their sheets with a sharp hobby knife or scissors. A straight edge makes this easier when straight lines are involved. Trim as close to the image as possible.

Putting sticky-back decals on a model can be tricky, especially medium to large size ones, like some of those in this kit. If you don't do it right, you will end up with unsightly air bubbles trapped underneath the decal. The best method is to put large decals on "wet". This technique involves using a "soapy water" mixture to float the decal on the surface of the model until you get it in correct position, and then use a squeegee to press the decal permanently in place.

The soapy water mixture can simply be water mixed with a very small amount of dish soap, or SIG Pure Magic Model Airplane Cleaner, or Fantastic®, or Windex®, or 409® type household cleaners - they all work great. For a squeegee, we recommend the SIG 4" Spreader #SIGSH678, or simply use some scraps of sheet balsa. You will also want to have some soft paper towels or clean soft cloths (old tee shirts are great) handy.

First, spray the surface of the model where the decal is to be placed with a soapy water mixture. Then, carefully peel the decal completely off the backing sheet, being careful not to let the sticky side double over and adhere to itself. Then, spray the adhesive side of the decal as well. Lightly position the decal in place on the wet surface of the model. Do not push down! The liquid allows you to slide the decal into the desired final position, as long as you don't press down on it. Once you have it in position, gently squeegee the excess liquid out from under the decal, starting from

the middle and working out towards the edges. Mop up the liquid with a dry cloth. Squeegee repeatedly to get as much of the water out from under the decal as possible. Allow the decals to set overnight to finish drying. Once dry, they will be solidly adhered to the model.



## CONGRATULATIONS!

Your KADET SENIOR is completely assembled. However, it is **NOT** ready for flight! There are a few very critical pre-flight tasks we must perform before flying. These are extremely important and should be approached with patience and care.

## BALANCE YOUR AIRPLANE

This may be the single most important step in preparing your airplane for flight. All airplanes, model or full-size, must be accurately balanced in order to fly successfully. An airplane that is not properly balanced will be unstable and will most likely crash.

### **NOT ALL KADETS WILL BALANCE THE SAME**

It is impossible to produce a model airplane kit that will automatically have the correct balance point. Not everyone uses the same engine/motor or radio gear - and all those items can vary in weight! You might be surprised to know that .40 size 2-stroke R/C engines can vary in weight from 11 oz. to 18 oz. - that's almost a half pound difference, way out on the nose of your model! There can even be as much as a 3/4 oz. difference in weight between different brands of propellers! So, that's why every model must be balanced before flying. Don't feel that whatever the balance point your model came out at is "good enough". Check carefully and make whatever adjustments are required. Trying to fly an out of balance model is dangerous!

Preliminary: All the parts and components that will be in the airplane in flight must be installed in their correct positions. This includes all the radio gear, the propeller, spinner, muffler (if applicable), etc. Every piece of essential equipment must be installed, ready for flight. Always balance a glow powered model with the fuel tank empty. Always balance an electric powered model with the battery pack in place.

**RECOMMENDED BALANCE RANGE**  
**Between 4" to 5" Behind The Leading Edge Of The Wing**  
(Anywhere within this range is acceptable.)

Using a ruler, measure back from the leading edge of the wing and mark the balance range on the bottom of the wing, next to the fuselage. Make the same marks on both sides of the fuselage. Place your fingertips within the balance range on both sides of the airplane and carefully lift it off the table. No part of the model

should be touching anything except your fingertips! If the KADET SENIOR will sit on your fingertips in a level attitude, then it is properly balanced and ready to fly.

If the airplane sits on your fingertips in an extreme nose down attitude, then it is nose heavy. You will have to add weight to the rear of the airplane to get it to balance. NOTE: Before adding additional weight to the model, try simply moving the battery pack to a further aft location. The battery pack is relatively heavy and therefore makes a good balancing tool. You might try switching places between the battery and receiver; or move the battery right in front of the servos; or in extreme situations, move it behind the servos. If you can't get your model balanced simply by re-locating the battery pack, then you will have to purchase lead weights from your hobby dealer and glue them into the tail end of the fuselage.

If the airplane sits on your fingertips with the tail down, it is tail heavy. DO NOT ATTEMPT TO FLY IT! A tail heavy model is very dangerous and will most likely crash!! Weight will have to be added to the nose of the model to bring it into balance. The weights can be glued to the front of the firewall; or inside the cowling. There are also "spinner weights" available for tail heavy models. Wherever you put the balancing weight, make sure it cannot come loose in flight!

Because the KADET SENIOR EG ARF has so much wing area, adding balancing weight will have little effect on its flying ability.

## CONTROL SURFACE TRAVEL

Double check the alignment and movement of all the controls one more time! Adjust all of your pushrod linkages so that the control surfaces are in their neutral position when the transmitter sticks and trim levers are centered. Make sure the control surfaces move in the proper direction when you move the sticks. You'd be amazed to know how many models have been destroyed on takeoff with one of the controls reversed. Don't let it happen to you! In fact, it's a good idea to get into the habit of checking for proper control response every time you get ready to fly.

Adjust your pushrod linkages and/or transmitter EPA (End Point Adjustment) settings as necessary to provide the recommended amount of control surface travel. NOTE: The rudder measurement is taken from the bottom of the rudder, at its widest point.

### RECOMMENDED CONTROL SURFACE TRAVEL

**AILERONS: 1" UP, 1" DOWN**  
**ELEVATOR: 3/4" UP, 3/4" DOWN**  
**RUDDER: 1" LEFT, 1" RIGHT**

## FLYING

The KADET SENIOR is designed to give you the best possible chance to succeed in learning to fly R/C. However, learning to fly model airplanes is not a skill you can learn overnight. It's very similar to learning to fly a real airplane in that you should go through a learning phase with an instructor before you try to pilot the airplane yourself. A lot of things can go wrong with these machines, and if you are not prepared to deal with them instantly, you will lose your brand new airplane in a crash. To practically eliminate any chance that your first flight will end in disaster, we strongly recommend that you seek the assistance of a competent R/C pilot to help you with your first flights.

An instructor serves two purposes. First, he will take your model up for its first test flight to make sure it is performing properly before you try to fly it. When a brand new R/C model takes off for the first time, there is no way of knowing which way it is going to go. Some models will try to climb steeply, while others may want to go down. Some will try to turn left, others right. Some models will be doing both at the same time! It doesn't mean that there is anything wrong with the model, but these minor differences must be "trimmed out" in order for the model to fly "hands-off" straight and level. An experienced pilot can instantly correct for out of trim conditions before the model crashes into the ground. An inexperienced beginner has almost no chance of saving an out of trim model!

The second reason for an instructor is to have someone there who can correct any mistakes you make when you take over the controls for the first time. Let the instructor get the model airborne and flying straight and level at a safe attitude ("several mistakes high" as the old saying goes) before he turns the transmitter over to you. You will quickly find out that it is very easy to over control an R/C model and to get disoriented - EVERYONE DOES IT AT FIRST! If you get out of control on your first flight, quickly hand the transmitter back to your instructor so he can rescue the airplane. He will get it leveled off and then let you try it again. Without an instructor, you would not get a second chance!

It's not that learning to fly R/C is difficult, it's just a lot different than anything you have ever done before. Anyone can learn to fly the KADET SENIOR if they are willing to listen and learn! Remember the first time you tried to ride a bicycle? It seemed completely awkward the first time, but once you learned how, it quickly became very easy. Learning to fly R/C model airplanes also comes quickly to many people. Fly your KADET SENIOR as often as possible. After you get a few flights under your belt with an instructor at your side, you will begin to feel more comfortable at the controls. Soon you will be flying "solo" with little thought of the moves required.

Because of its large size and relatively light wing loading, the KADET SENIOR is best flown in light or no wind conditions. For initial test flights, we strongly recommend that you choose a calm day with little wind. That way the airplane can be much more easily and accurately trimmed. The goal is to trim the airplane for "hands off" level flight at cruising speed.

On the initial test flight, you may find that you need a little "down" trim in the elevator to get your KADET SENIOR to fly level. This is not uncommon and is perfectly normal for a flat-bottom airfoil airplane. Flat bottom airfoils are very speed sensitive - i.e. the faster the airplane flies, the more it wants to climb. Airplanes like the KADET SENIOR, with a very light wing loading, also have a very wide speed range. The speed at which you fly the KADET will determine the elevator trim setting you need to achieve hands-off level flight. You will also find that everytime you change your throttle setting (and thus your airspeed) you need to change your elevator trim. So don't be alarmed if you need a little down elevator trim to fly hands-off level at your cruising speed. It's not uncommon for this type of airplane. Most KADET SENIORS will fly level at "normal" cruising speed with the elevator drooped down about 1/8" or so.

The KADET SENIOR is capable of mild aerobatics, such as loops, Immelman turns, stall turns, slow rolls, etc. However, the design is really all about training beginning pilots and leisurely slow flying.

Good luck and safe flying!

## **WARNING! THIS IS NOT A TOY!**

Flying machines of any form, either model-size or full-size, are not toys! Because of the speeds that airplanes must achieve in order to fly, they are capable of causing serious bodily harm and property damage if they crash. **IT IS YOUR RESPONSIBILITY AND YOURS ALONE** to assemble this model airplane correctly according to the plans and instructions, to ground test the finished model before each flight to make sure it is completely airworthy, and to always fly your model in a safe location and in a safe manner. The first test flights should only be made by an experienced R/C flyer, familiar with high performance R/C aircraft.

The governing body for radio-control model airplanes in the United States is the **ACADEMY OF MODEL AERONAUTICS**, commonly called the **AMA**. The **AMA SAFETY CODE** provides guidelines for the safe operation of R/C model airplanes. While AMA membership is not necessarily mandatory, it is required by most R/C flying clubs in the U.S. and provides you with important liability insurance in case your R/C model should ever cause serious property damage or personal injury to someone else. For more information, contact:

**ACADEMY OF MODEL AERONAUTICS**  
5161 East Memorial Drive  
Muncie, IN 47302  
Phone: (765) 287-1256  
**AMA WEB SITE:** [www.modelaircraft.org](http://www.modelaircraft.org)

## **CUSTOMER SERVICE**

SIG MFG. CO., INC. is totally committed to your success in both assembling and flying the KADET SENIOR EG ARF kit. Should you encounter any problem building this kit or discover any missing or damaged parts, please feel free to contact us by mail or telephone.

**SIG MFG. CO., INC.**  
PO Box 520  
401 South Front Street  
Montezuma, IA 50171-0520

**PHONE:** (641) 623-5154  
**FAX:** (641) 623-3922

**SIG WEB SITE:** [www.sigmfg.com](http://www.sigmfg.com)  
**SIG E-MAIL:** [mail@sigmfg.com](mailto:mail@sigmfg.com)

## **LIMIT OF LIABILITY**

The craftsmanship, attention to detail, and actions of the builder/flyer of this model airplane kit will ultimately determine the airworthiness, flight performance, and safety of the finished model. SIG MFG. CO.'s obligation shall be to replace those parts of the kit proven to be defective or missing. The user shall determine the suitability of the product for his or her intended use and shall assume all risk and liability in connection therewith.