

ASSEMBLY MANUAL



RASCAL 72 EG

KIT NO. SIGRC83EGARF

ALMOST READY TO FLY



Fly With Electric Or Glow Power!

Wingspan: 72 in. (1829 mm)
Wing Area: 720 sq.in. (46.5 dm²)
Length: 51-3/4 in. (1315 mm)
Flying Weight: 5 - 5.5 lbs. (2268 - 2495 g)
Wing Loading: 16 - 17.6 oz./sq.ft. (49 - 54 g/dm²)
Radio Required: 4 Channel with 5 Standard Servos
Glow Power: 2-Stroke .40 - .46 cu.in. (6.5 - 7.5 cc)
4-Stroke .40 - .54 cu.in. (6.5 - 8.8 cc)
Electric Power: 500-800 watt Brushless Motor
50 - 60 amp ESC; Lipo Battery Pack

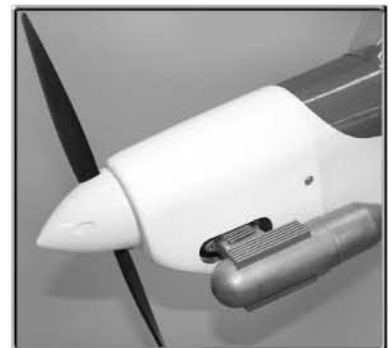
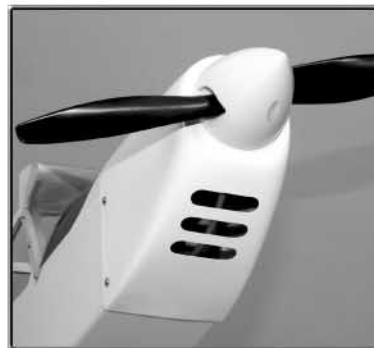

SIG MFG. CO., INC. PO Box 520 Montezuma, IA 50171-0520
www.sigmfg.com



INTRODUCTION

Congratulations on your purchase of the SIG RASCAL 72 EG ARF kit. The legend of the RASCAL began with a small rubber-powered free-flight model in the 1950s. Adapted for modern radio control, the RASCAL's classic good looks and dream-come-true flying characteristics have made it the favorite everyday airplane of thousands of R/C pilots.

SIG offers the RASCAL design in several sizes. This 72 inch wingspan version gives you the option of using either glow or electric power. Whichever power system you choose, you'll find that this RASCAL flies as good as it looks. Streamlining and a high performance airfoil allow the RASCAL to do aerobatic maneuvers better than most typical high wing designs. This will very likely become your favorite everyday R/C airplane!

Assembly of the RASCAL 72 EG ARF is fast and simple when following the detailed instructions in this manual. A low parts count and professional engineering ensure quick and easy assembly. All parts are CAD-drawn, laser-cut, and jig assembled, which means that everything fits the way it should!

We urge you to read this assembly manual completely before assembly. Familiarize yourself with the parts and the assembly sequences. The successful assembly and flying of this airplane is your responsibility. If you deviate from these instructions, you may wind-up with problems later on.

Good luck with the RASCAL. Let's get started!

ADDITIONAL ITEMS YOU WILL NEED TO PURCHASE

In addition to this kit, you will need the following items to complete your RASCAL 72 EG ARF and make it flyable.

❑ RADIO SYSTEM

The RASCAL 72 EG requires a standard 4-channel radio system and five standard size servos. In addition, you'll need two 12"-24" long Servo Extension Chords (actual length needed will depend on how long the wires are coming off your servos - plan accordingly), and one Y-Harness Chord for connection of the two aileron servos to the receiver.

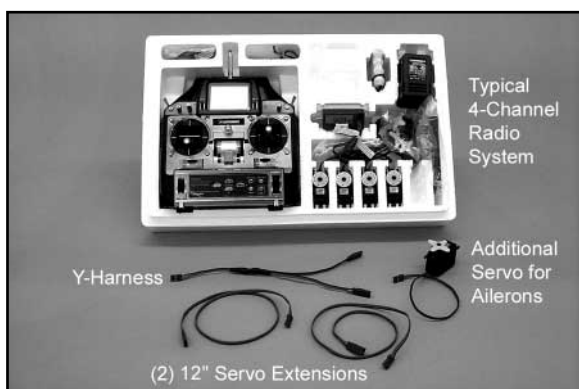

POWER SYSTEM - GLOW OR ELECTRIC?

The biggest decision you will have to make is whether to power your RASCAL 72 with a glow engine (2-stroke or 4-stroke) or an electric motor. We have flown the RASCAL 72 on a variety of both types of power systems, and we make the following recommendations based on our successful on-field experience.

GLOW POWER RECOMMENDATIONS

❑ ENGINE

We recommend the following size for the RASCAL 72.

- 2-STROKE - .40 to .46 cu. in.
- 4-STROKE - .40 to .54 cu. in.

Whatever brand engine you choose, take the time to carefully break it in according to the manufacturer's instructions. A good running, reliable engine is a minimum requirement for the enjoyment of this or any R/C model aircraft.

❑ PROPELLER FOR GLOW

Refer to the engine manufacturer's instructions for recommendations on proper propeller size for their engine. In our experience, most 2-stroke .40-.46 glow engines will fly the RASCAL 72 very nicely with a 10x6 or 11-6 prop.

ELECTRIC POWER RECOMMENDATIONS

❑ 500 - 800 watt BRUSHLESS OUTRUNNER MOTOR

There are many fine 500 to 800 watt electric outrunner motors on the market that will fly the RASCAL 72. We use the Maxx Products Himaxx HC3528-1000 Brushless Outrunner Motor.

- Specs: case diameter: 35mm
- case length: 54mm
- stator diameter: 28mm
- magnet length: 28mm
- weight: 197g (6.9 oz.)
- Kv = 1000
- Rm = .020
- Lo = 2.6

❑ MOTOR MOUNT

We use the Maxx Products #ACC3958 Large Motor Mount. This plastic cone-shaped mount provides the exact firewall-to-propeller distance needed to fit inside the RASCAL 72 cowling, without modifications. If you go shopping for another brand mount, you will need a mount that can provide 4-1/2" from the front of the firewall to the back of the propeller (or spinner if being used).

❑ 50-60 amp ESC (Electronic Speed Control)

We use the Castle Creations ICE 50 ESC or the Castle Creations Phoenix 60 ESC. We typically see amp draw of 30 to 48 amps, depending on whether a 3 cell or 4 cell lipo is being used, and the propeller size.

NOTE: The Castle Creations ESCs that we used, as well as the many of the other ESCs on the market, have a BEC (Battery Eliminator Circuit) built in. BEC allows you to use the same battery pack to power both your motor and your radio system, eliminating the normal radio battery pack. As the dual purpose battery runs down in flight, the BEC circuit in the ESC will shut down the motor and leave enough power to operate the radio while you land the model. However, the BEC feature in many ESCs does not work with 4 cell lipo battery packs - only 3 cell packs. Check the manual of your particular ESC to learn if this is true in your case.

If your ESC is only rated for 3 cell operation, you have three options: 1) fly only 3 cell lipo packs; 2) disable the BEC and install a normal receiver battery pack to run the radio full time; or 3) install an aftermarket BEC that is rated for 3 or 4 cells. We wanted to be able to fly both 3 cell and 4 cell packs interchangeably, so we chose option #2; using a normal receiver battery pack. The little bit of extra weight is no problem for the RASCAL 72. We then dis-

abled the BEC feature of our Castle ESC, since we no longer needed BEC. Disabling the BEC allows the speed control to be used with both 3 cell and 4 cell packs without problems. A common way to disable BEC in many ESCs is to remove or clip the middle wire from the plug on the ESC that goes into the radio receiver - see your ESC manual for more guidance.

3 or 4 cell 5300mah LITHIUM-POLYMER BATTERY PACK

With the Maxx Products HC3528-1000 motor we use 3 cell (3S1P) 5300mah or 4 cell (4S1P) 5300mah Li-po packs. A 3 cell pack (11.1 volts) provides flight performance similar to a .40 glow engine. A 4 cell pack (14.8 volts) provides flight performance similar to a .46 glow engine. We find that 5300mAh lipo packs provide between 10 to 18 minutes of flight time, depending on propeller selection and other factors (quality of pack, throttle management, outside temperature, etc.). CAUTION: You must match your propeller size to the cell count of your lipo pack, to avoid drawing too many amps and damaging your ESC or motor.

PROPELLER FOR ELECTRIC

With the Maxx Products HC3528-1000 motor and a 3-cell (3S1P) 11.1v lipo pack, we recommend a APC 11x7E, APC 11x8E, or APC 12x6E propeller. All three sizes delivered good performance, very reminiscent of a 2-stroke .40 glow engine. For a starting prop we recommend the APC 12x6E. Other brand propellers of same size and similar design can also be used. NOTE: Your results may vary due to other factors - the specs of your individual motor and battery pack, etc. You may need to experiment with different props to find your best combination.

With the Maxx Products HC3528-1000 motor and a 4-cell (4S1P) 14.8v lipo pack, we recommend a APC 10x6E, APC 10x7E, or APC 11x5.5E propeller. All three sizes delivered good performance, very reminiscent of a 2-stroke .46 glow engine. For a starting prop we recommend the APC 10x6E. Other brand propellers of same size and similar design can also be used.

Hi-Maxx "COMBO 40" Complete System

Maxx Products, the manufacturer of the motor that we used in this manual, markets a "Combo 40" electric motor system. The Maxx "Combo 40" package consists of (1) Hi-Maxx HC3528-1000 Brushless Outrunner Motor; (1) Prop Adapter Assembly; (1) Castle Creations 60 Amp Speed Control (ESC); and (1) APC 12-6E Propeller. It's a good system for the RASCAL 72.

Maxx Products, Inc.
815 Oakwood Rd.
Lake Zurich, IL 60047
www.maxxprod.com
Ph: 847-438-2233

BATTERY CHARGER

FOR SAFETY AS WELL AS PERFORMANCE, CHARGE LIPO BATTERIES ONLY WITH A LIPO BATTERY CHARGER!

In addition to providing the critical charging profile needed to safely charge lipo batteries, a lipo battery charger also includes the capability of "balancing" the available voltage in the cells, ensuring that the battery pack is at peak capacity at the end of the charge cycle. This translates to better flight times and a longer life from the battery pack.

REQUIRED TOOLS

For proper assembly, we suggest you have the following tools and materials available:

A selection of glues - SIG Thin, Medium, & Thick CA Glue
CA Accelerator, CA Debonder
SIG Kwik-Set 5-Minute Epoxy

Screwdriver Assortment
Pliers - Needle Nose & Flat Nose
Diagonal Wire Cutters
Small Allen Wrench Assortment
Pin Vise for Small Dia. Drill Bits

Hobby Knife with Sharp #11 Blades
Small Power Drill With Selection of Bits
Dremel® Tool With Selection of Sanding & Grinding Bits
Scissors
Sandpaper
Covering Iron & Trim Seal Tool
Masking Tape
Paper Towels
Alcohol and/or Acetone For Epoxy Clean-up

COMPLETE KIT PARTS LIST

The following is a complete list of all parts contained in this kit. Before beginning assembly, we suggest that you take the time to inventory the parts in your kit. Use the check-off boxes (q) provided in front of each part description. Please also note that the bolts and nuts required to mount your engine to the motor mounts are not included and must be purchased separately.

- (1) Fuselage
- (1) Right Wing Panel & Aileron, hinged
- (1) Left Wing Panel & Aileron, hinged
- (1) Horizontal Stabilizer & Elevator, hinged
- (1) Vertical Fin & Rudder, hinges not glued
- (1) Cowling with (4) M2.6 x 10mm PWA Mounting Screws
- (1) Right & Left Molded Clear Plastic Side Windows

Main Landing Gear

- (1) Formed Aluminum Main Landing Gear
- (2) 2-3/4" dia. Main Wheels
- (1) Right Fiberglass Wheel Pant
- (1) Left Fiberglass Wheel Pant
- (2) M4 x 40mm Mounting Bolts, for axles
- (4) M3 x 8mm Mounting Bolts, for wheel pant mounting
- (4) M3 Split-Ring Lock Washers, for wheel pant mounting
- (4) M4 Lock Nuts, for wheel and wheel pant mounting
- (4) M4 Flat Metal Washers, for wheel & wheel pant mounting
- (2) M4 x 20mm Mounting Bolts, for landing gear mounting
- (2) M4 Split-Ring Lock Washers, for landing gear mounting

Tailwheel Assembly

- (1) Leaf-Spring Assembly with Steering Arm & Tailwheel
- (1) 3-Arm Rudder Steering Horn, Metal
- (2) M2 x 10mm PWA Screws, for Rudder Steering Horn
- (3) M2.6 x 12mm PWA Screws, for Tailwheel Assembly
- (2) Coil Steering Springs

Spinner Assembly

- (1) 2-1/4" dia. White Spinner Cone
- (1) 2-1/4" dia. White Spinner Backplate
- (1) Prop Adapter Rings
- (2) T3 x 10mm Phillips-Head Mounting Screws

Aileron Servo Hatches

- (1) Right Plastic Aileron Servo Hatch
- (1) Left Plastic Aileron Servo Hatch
- (4) 5/16" X 1/2" X 7/8" Hardwood Servo Mounting Blocks
- (8) M2.6 x 8mm PWA Screws for servo hatches
- (4) M2 x 6mm PWA Screws for servo blocks

Control Horns, Etc.

- (4) Nylon Control Horns; for ail(2); elev(1); rud(1)
- (8) M2 x 20mm Mounting Bolts; for control horns
- (2) 1/4-20 x 1-1/2" Nylon Wing Bolts
- (1) 5/16" x 3/4" x 3-3/16" Balsa Fuel Tank Retainer

Pushrods

- (2) 1/8" dia. x 25-1/2" Nylon Inner Pushrod Tubes, rud. & ele.
- (1) 1/8" dia. x 16" Nylon Inner Pushrod Tubes, for throttle

- (8) Metal R/C Links, for ail(2), elev(2), rud(2), throttle(2)
- (6) M2 x 22mm Threaded Studs
- (2) 3" Aileron Pushrods, threads one end, "Z-bend" other end

Miscellaneous

- (1) Aluminum Front Wing Joiner Blade
- (1) 3/16" dia. x 2-3/8" Steel Rear Wing Locating Pin
- (1) Decal Sheet

Fuel Tank for Glow Engine

- (1) Fuel Tank Body - 260cc (8.8 oz.)
- (1) Rubber Stopper
- (1) Metal Front Clamp
- (1) Metal Rear Clamp
- (1) M3 x 18mm Bolt
- (1) Metal Clunk Pick-Up
- (1) Fuel Tubing (inside tank)
- (1) Aluminum Tube - 3mm od x 60mm
- (1) Aluminum Tube - 3mm od x 50mm
- (1) Aluminum Tube - 3mm od x 40mm

Engine Mounts for Glow Engine

- (1) Right Engine Mount
- (1) Left Engine Mount
- (4) M3 x 20mm Mounting Bolts
- (4) M3 Flat Metal Washers
- (4) M3 Blind Nuts
- (4) M3 Split-Ring Lock Washers

NOTE: "PWA Screws" are metal screws with a phillips/washer style head.

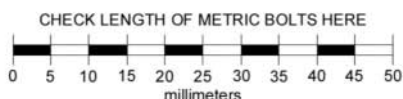

COVERING MATERIAL

Your RASCAL ARF is covered with ORACOVER®, a premium quality covering made in Germany, and sold in the U.S. by Hanger-9 as Ultracote®.

Colors Used On Your Airplane

ORACOVER® #10 White (Ultracote® #HANU870)

and

ORACOVER® #29 Transparent Red (Ultracote® #HANU950)

or

ORACOVER® #59 Transparent Blue (Ultracote® #HANU954)

If sometime in the future you need replacement covering or matching paint for repairs, they are available from your local hobby dealer or online from Hanger-9.

How To Tighten Loose Covering

After you open your RASCAL 72 and take all the covered parts out of their plastic bags, the covering may begin to wrinkle. This is not unusual and is no cause for alarm.

Your airplane was built and covered in a part of the world which has relatively high humidity and therefore, the wood was likely carrying a fair amount of moisture. When exposed to drier air, the wood typically loses this moisture, dimensionally "shrinking" in the process. In turn, this may cause some wrinkles. However, wrinkles are easy to remove by just using a hobby type heat iron. Caution: Trying to remove the wrinkles by hastily going over them with a heat gun can lead to more problems. You should take your time to carefully go over the entire model with a covering iron, as we will describe.

We suggest using a model airplane covering iron for this process. Cover the iron's shoe with a thin cotton cloth, such as an old t-shirt, to prevent scratching the covering as you work.

After covering your iron, the next step is to set the iron to the correct temperature. This is critical for achieving a good result! The iron should be set to about **220°F - 250°F (104°C - 121°C)** as measured on the bottom of the iron using a thermometer.

If you do not have a thermometer, you can find the correct temperature by trial and error. Set your iron to a medium setting. Glide the iron over some of the covering that is over solid wood, such as the sheeted wing center section. Observe the covering to see if any bubbles appear. If bubbles appear, the covering is getting too hot! Turn down the temperature of the iron and repeat the test.

If no bubbles appear, turn up the heat slightly and repeat the test. Keep adjusting until you "zero in" on the correct temperature. Find the temperature that will get the covering to stick down without forming bubbles or causing the seams to pull away.

Once your iron is set to the correct temperature, go over the entire framework of the airplane, making sure that the covering is securely bonded to the structure everywhere the covering comes in contact with the wood underneath. This takes some time, but is worth the effort.

After you have all the covering secured onto the solid areas, turn the temperature of the iron up to approximately **300°F - 320°F (149°C - 160°C)**. This is the correct temperature for shrinking the covering material.

Use the iron to tighten up any wrinkles in the "open" areas of the model (no wood underneath the covering). Glide the iron over the wrinkle for a few seconds, then remove. Repeat until the covering is tight with no wrinkles.

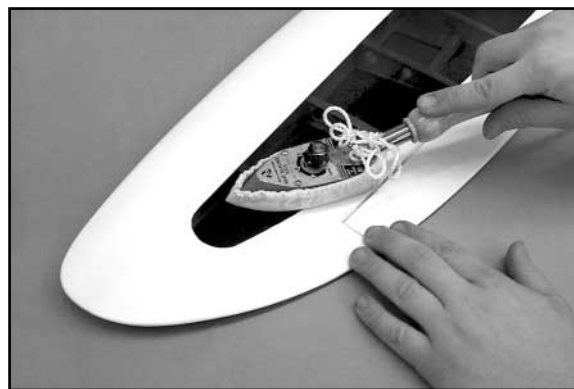

If wrinkles keep coming back on the tail surfaces, you may need to "ventilate" the areas between the ribs. Otherwise the air that is sealed in those relatively small areas will expand when the heat is applied and actually cause the covering to stretch instead of shrink. Use a pin to poke a tiny hole in the covering between each rib, on the bottom of the part. That will let the expanding air escape and the covering to shrink properly.

Caution When Using Heat Guns: You can also use a hobby-type heat gun to shrink the covering, but you must be careful around seams or color joints. Getting too much heat on the seams may cause them to "creep" or come loose. You must also be careful when using a heat gun when working around the windshield and side windows - heat will distort the clear plastic material.

Recommended Temperatures:

To adhere the covering - 220°F - 250°F (104°C - 121°C)

To shrink the covering - 300°F - 320°F (149°C - 160°C)

NOTE: In this manual, any references to right or left, refer to your right or left as if you were seated in the cockpit of the airplane.

WING ASSEMBLY

The wings are designed as a 2-piece system, with separate right and left wing panels joined by an aluminum blade Front Wing Joiner and a steel Locating Pin at the rear. This system has proven to be very tough. An obvious benefit is the fact that the wing panels can be easily transported or stored, requiring a minimum of space. Also, you might want to consider using 5-minute epoxy to permanently install the aluminum blade wing joiner and the rear steel locating pin into one of the wing panels. Doing this prevents accidentally losing these parts - your call. Note that the ailerons have been factory-hinged. Flex them up and down a few times to loosen them up and they are ready to use.

For the following steps you will need two standard-size Servos for the ailerons, two 12"-24" Servo Extension Chords and one dual servo Y- Harness for your particular radio system.

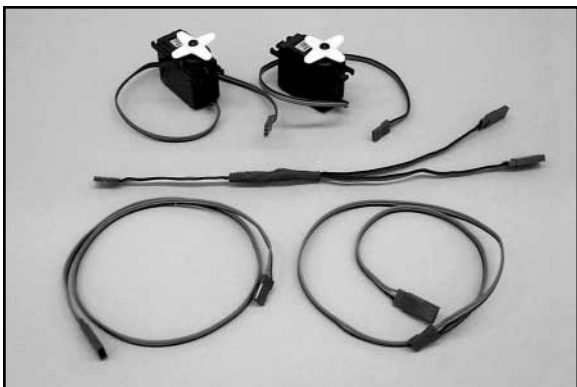

□ 1) The aileron servos will be mounted in the bottom of each wing panel. Notice the servo bay openings located just in front of the ailerons, in the bottom of each wing panel. Inside the servo bay opening you will see a short length of balsa wood with a string tied to it. This string will be used later to pull the aileron servo chord through the wing - leave it in place for now.

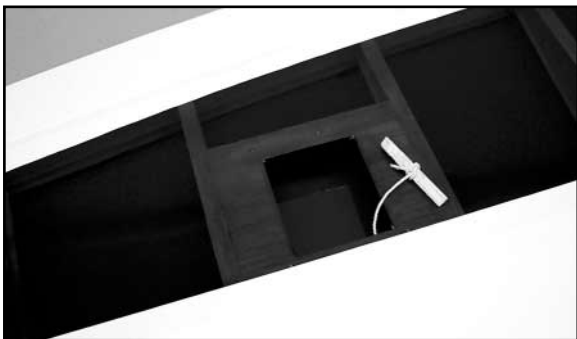

Also on the bottom of each wing panel, near the front at the center, you will see an oblong opening. This is the exit hole for the servo chord. Inside this opening you will see another piece of wood with a string tied to it - this is the other end of the string in the aileron servo bay. Leave the string in place for now.

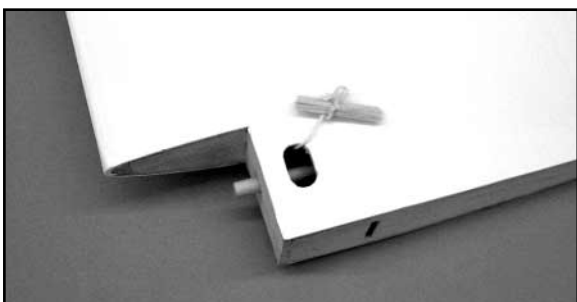

□ 2) First we will mount the aileron servos onto the molded plastic Aileron Servo Hatches.

a) Begin by installing the rubber grommets and brass eyelets (supplied with your radio system) into each servo.

b) Use epoxy to glue two Hardwood Servo Mounting Blocks to the inside surface of the plastic Hatch. Use the servo to determine the correct spacing and location for the blocks. Be sure to locate the servo with the output arm directly in the center of the pushrod fairing that is molded into the hatch, as shown. Allow the epoxy to dry.

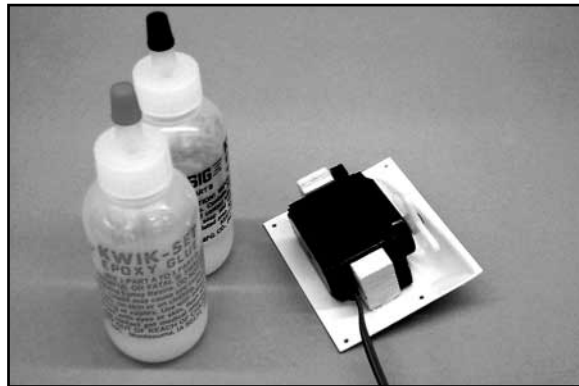

c) M2 x 6mm PWA Screws are provided to reinforce the mounting of the hardwood servo blocks to the plastic hatch. Mark the center of both blocks on the top (plastic) side of the hatch. Tip: Hold the hatch up to a light (blocks towards the light), and you will be able to see a shadow on the plastic side indicating where the blocks are located.) Drill a 1/16" dia. pilot hole about 1/4" deep, through the hatch and into the mounting block. Install a screw in the hole. Repeat to install a screw in the other mounting block.

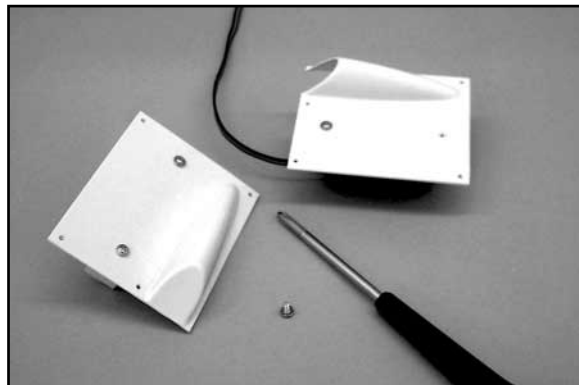

d) Use a Dremel® Tool and a tapered sanding drum bit to open the end of the pushrod fairing in the plastic hatch, where the pushrod will pass through from the servo arm to the aileron horn.

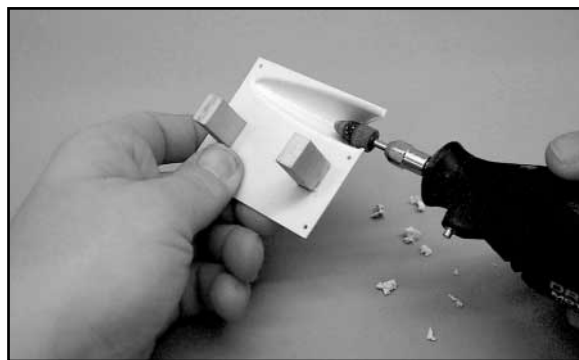

e) Mount your aileron servo to the hatch, using the screws that were provided with the radio system. Be sure to drill pilot holes in the mounting blocks before screwing the servo in place.

f) Repeat steps 2a) through e) to mount the other aileron servo to the other plastic hatch.

- 3) Next we install the servo wires inside the wing panels.
 - a) Plug a 12"-24" long servo extension chord onto the end of the aileron servo wire. Wrap the connection with a piece of plastic tape to insure that it won't come unplugged.

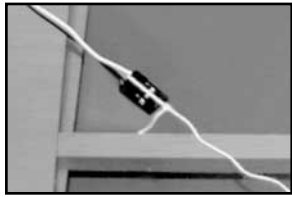

- b) Reach into the aileron servo bay and gently break the small balsa stick loose from the wing structure. Pull it out and unwrap the extra string. Remove the string from the wood. Tie the end of the string securely to the end of the servo wire plug. Tie it in such a manner that the plug will be pulled narrow end first through the wing. Wrap a piece of tape around the plug to keep the string in place.

- c) Break loose the balsa stick that has the opposite end of the string tied to it - from its location at the inboard end of the wing panel. Begin carefully pulling the string and the aileron chord through the wing towards the end of the wing panel. You may occasionally feel like the wire has become stuck inside the wing. This is simply the plug on the end of the servo wire hitting the side of one of the holes in the wing ribs. Gently work the string back and forth from both ends until the plug slips through the hole. Sometimes the servo plug comes through all the ribs the first time without getting hung up, and other times it seem like it gets hung up on every rib. Be patient and don't try to force it. The holes in the ribs are large enough to get any common servo plug through.

- d) When the servo plug appears in the round hole, reach in with a narrow needle nose pliers or a hemostat and grasp the plug and pull it out of the hole. Pull the servo lead fully out of the hole, leaving very little slack in the aileron servo bay. Remove the string from the servo plug and temporarily tape the plug to the wing surface so it can't fall back inside the wing. Repeat this step to pass the other aileron servo wire through the other wing panel.



- 4) Fit the plastic Aileron Servo Hatch, with servo mounted, in place in the wing. Check carefully to make sure the servo arm can operate properly without binding on the wing structure. Use pieces of masking tape to hold the servo tray in final position. Using the pre-drilled mounting holes in the servo tray as your guide, drill four 1/32" dia. pilot holes through the sheeting in the bottom of the wing. Then mount the hatch using the provided M2.6 x 8mm PWA Screws. Repeat this step to mount the other servo hatch in the other wing panel.

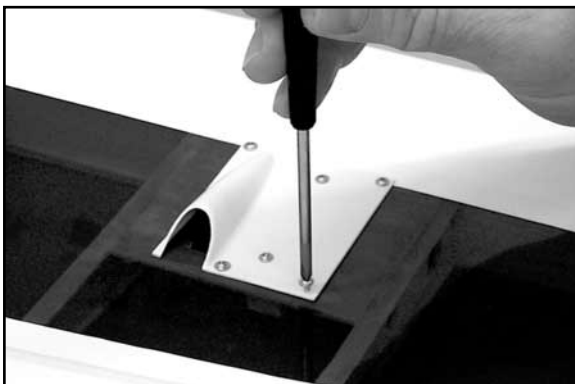

- 5) From the kit contents locate two Nylon Control Horns, four M2 x 20mm Mounting Bolts and two wire Aileron Pushrods (threaded at one end, "Z"-bend at the other end), and two metal R/C Links.

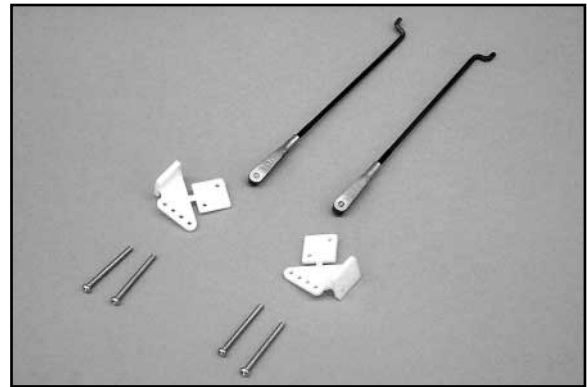

You will likely need to use a small drill to open the holes in the servo arm in order to accept the .070" dia. pushrod wire. Slip the "Z"-bend end of the wire pushrod into the outer hole in the servo arm and then install the arm on the servo with the arm facing 90° down into the pushrod fairing of the servo hatch, as shown (this is the ideal "neutral" position for the servo with the radio system on). Thread a metal R/C Link halfway onto the aileron pushrod, allowing an equal amount of adjustment in either direction.



Now is a good time to check the movement and centering of the aileron servos with your radio system. Connect the aileron servo chords to the Y-Harness and plug it into the aileron receptacle in your receiver. Connect the battery and turn the system on. First check for the correct direction of travel. Reverse the servo direction on your transmitter if necessary. Next, check the centering of the servo arms, with the trim lever in neutral. Remember that the output arm should be facing directly into the molded fairing in the servo hatch, at 90° to the servo. Take off and reposition the output arm as needed to achieve this. With these two issues addressed, install and tighten the servo output arm screws in both servos. Carefully re-install the servo and hatch back into the wing panel and secure it with the screws.

Next, use a couple of pieces of masking tape to hold the ailerons in neutral position for the next step.

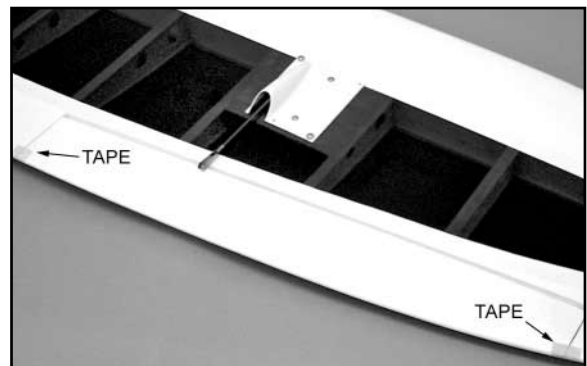

GLOW ENGINE INSTALLATION

❑ 6) Use a sharp blade to separate the nylon Control Horn and its Mounting Plate. With the wing panel upside down on the workbench, clip one of the control horns into the metal R/C Link on the end of the aileron pushrod (use the second from the top hole of the control horn). Then hold the base of the control horn down flat against the aileron. Ideally we want the base of the control horn to be right up against the front edge of the aileron, which should put the R/C Link/Control Horn pivot point directly over the aileron hinge line. If the base of the control horn is too far back or forward, screw the R/C Link in or out on the pushrod as needed to achieve the correct location for the control horn. When satisfied with the pushrod length, use a pencil to mark the two holes in the control horn base onto the aileron. Then remove the control horn from the metal R/C Link for the next step.

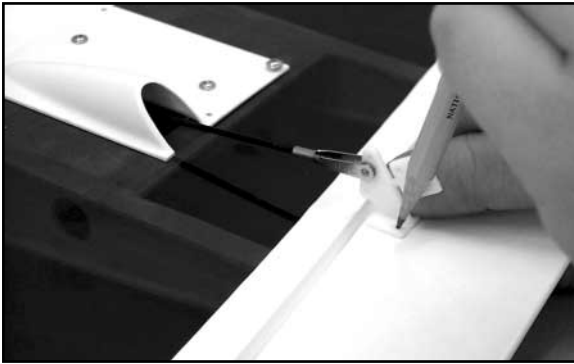

❑ 7) At one of the marks just made, drill a 3/32" dia. hole all the way through the aileron, perpendicular to the bottom surface. Slip a M2 x 20mm Bolt through the appropriate hole in the nylon control horn and push the bolt through the aileron. Position the horn and drill the remaining bolt hole, again perpendicular to the bottom surface of the aileron. Thread another M2 x 20mm Bolt through the control horn base and the aileron. Adjust the drilled holes as needed to line-up with the holes in the nylon Mounting Plate. Align the holes in the mounting plate with the tips of the bolts protruding from the top of the aileron. With a small phillips screwdriver, thread the bolts into the holes in the mounting plate, securing the horn to the aileron. Do not over-tighten the bolts and crush the balsa wood aileron. Repeat this procedure with the remaining wing panel. When done, re-connect the R/C Links to the control horns.

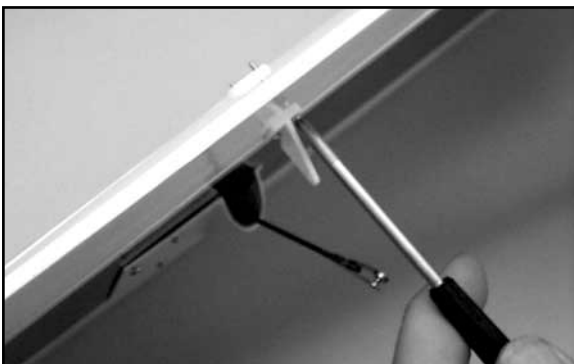

Skip this section if you are planning to use an electric motor. Detailed instructions on installing an electric power system begin on page 11.

The basic design of the RASCAL 72 EG is intended for mounting your glow engine inverted in the nose. Over the years there have been stories about inverted engines and how they run, primarily having to do with "flooding" during starting. In our considerable experience with running engines in the inverted position, we've found that both two and four-stroke engines work perfectly fine in the inverted position, with no more tendency to "flood" than engines mounted in other positions. The difference can generally be found in the starting procedures used by individual modelers. Flooding can be minimized by remembering to keep the carburetor closed between flights and during fueling. When first starting the engine, keep the throttle in the low position. Using an electric starter is recommended. Avoid "choking" fuel through the line by placing your finger over the carburetor. Allow muffler pressure and your starter to draw a small amount of fuel to the carburetor. Incorporating these simple precautions into your starting routine should make it easy to start your inverted engine every time.

Installing your engine in the RASCAL 72 will require some custom installation work, based on the particular engine you've chosen. While the installation of either a 2-stroke or 4-stroke glow engine is basically the same, there are small differences. The primary difference will probably be in the throttle arm location (4-stroke engines will usually have the throttle arm on the opposite side compared to a 2-stroke engine). Also the muffler style and location is different between the two types of engines. Notice that a plastic throttle pushrod sleeve is factory-installed in the RASCAL fuselage, but it is not yet glued in place. Also, note that there are identical holes in the firewall and formers to allow the throttle pushrod to be installed on either the right or left side of the airplane, depending on which side is correct for your engine.

Locate the following parts from the kit contents:

- ❑ (1) Right Glass-Filled Engine Mount
- ❑ (1) Left Glass-Filled Engine Mount
- ❑ (4) M3 x 20mm Mounting Bolts
- ❑ (4) M3 Flat Metal Washers
- ❑ (4) M3 Blind Nuts
- ❑ (4) M3 Split-Ring Lock Washers
- ❑ (1) 1/8" od x 16" Nylon Inner Throttle Pushrod Tube
- ❑ (2) M2 x 7/8" Threaded Studs for throttle pushrod
- ❑ (2) Metal R/C Links
- ❑ (1) 260cc (11.8 oz) Fuel Tank Assembly
- ❑ (1) 5/16" x 3/4" x 3-3/16" Balsa Stick
- ❑ (1) Cowling
- ❑ (4) M2.6 x 10mm PWA Screws for cowl mounting
- ❑ (1) Spinner Assembly, 2-1/4" dia., white

You will also need to acquire these items (not supplied):

- ❑ (1) R/C Engine and suitable Propeller
- ❑ (4) Socket-Head Engine Mounting Bolts
- ❑ (4) Lock Nuts for engine mounting bolts
- ❑ (4) Flat Metal Washers for engine mounting bolts
- ❑ (2) 6" lengths of Silicone Fuel Line Tubing
- ❑ (1) Silicone Sealer (common kitchen & bath type)

ENGINE AND MOUNTS

The engine shown in these instructions, is a typical .46 size 2-stroke engine. It is being mounted in the inverted position.

- ❑ 1) There are four sets of "circled cross-hairs" etched on the front of the plywood firewall to mark the locations of the mounting holes for the glow engine mounts. These hole locations should

accommodate any standard glow engine in the specified size range. Drill the four mounting holes with a 9/64" or 5/32" drill bit.

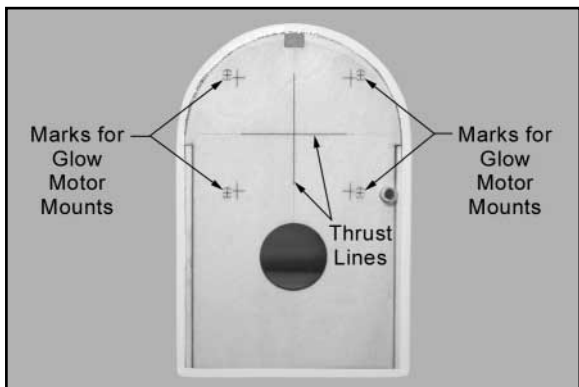

□ 2) Install the M3 blind nuts on the back of the firewall. The best method is to use one of your mounting bolts, with a flat washer on it, from the front side of the firewall to "draw" the blind nut into the back side. Keep tightening the bolt until the prongs of the blind nut are completely locked into the plywood. After you get all four blind nuts in place, apply a little glue around the flanges of the blind nuts to keep them from coming loose. Be careful not to get any glue in the threads of the blind nuts.

HELPFUL HINT: It's never easy putting a blind nut on the backside of the firewall of a pre-built model. Here's a handy trick! Take a stick of scrap balsa wood - 1/4" sq. x 10"-12" long works well in most cases - and put a piece of doubled-up tape (any kind) on the end, and then stick the blind nut to the tape. With this stick you can reach inside the nose of the airplane and hold the blind nut in position while you screw in the mounting bolt from the front of the firewall. If the model structure doesn't allow a straight shot at the location, cut an angle on the end of the stick to allow you to hold the blind nut at the correct angle.

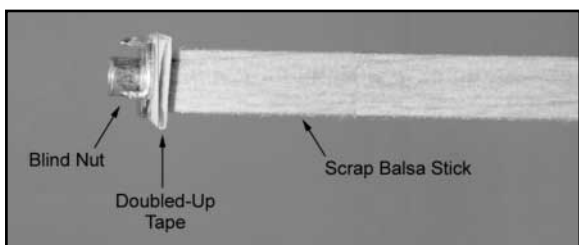

□ 3) Bolt the engine mounts in place on the front of the firewall with four M3 x 20mm mounting bolts, four M3 flat metal washers, and four M3 split-ring lock washers. Leave the mounting bolts slightly loose for now - do not tighten them until the next step.



□ 4) Set your engine in place on the beams of the engine mounts. If the beams of the mounts are too far apart to fit your engine, slide the mounts closer together. If they are already too close together, slide them apart. Notice that the holes in the mounts for the bolts are slotted to allow you to adjust the mounts to fit your engine. After you get the mounts in correct position,

tighten all four mounting bolts, securing the engine mounts on the firewall.

□ 5) Slide the engine forward or aft on the engine mounts until the front of the engine's thrust washer is 4-1/2" from the front of the firewall.

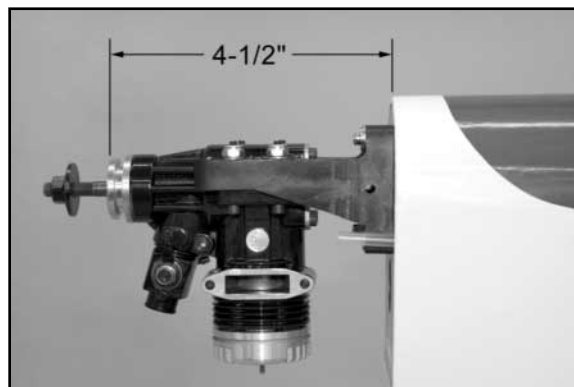

□ 6) Double check to make sure that the engine is pointing exactly straight forward, and then mark the locations of the engine mounting holes onto the beams of the engine mounts, using a center punch or sharpened nail.

□ 7) Unbolt the engine mounts from the firewall and drill holes thru the beams of the mounts at each location. We recommend that you secure the engine mounts in a vise while you drill the holes. Also, if at all possible, use a drill press to drill these holes. You can drill them by hand, but if you have access to a drill press, the job will be much easier and the holes will be straighter.

NOTE: Engines in the .40 to .46 size range are right at the break point between using 4-40 size or 6-32 size mounting bolts. Some .40-.46 engines have small holes in their case for 4-40 bolts, while other .40-.46 engines have holes large enough to accommodate 6-32 bolts. Be sure to buy the size appropriate for your engine.

Drill 1/8" dia. holes if you are using the 4-40 mounting bolts.
Drill 5/32" dia. holes if you are using 6-32 mounting bolts.

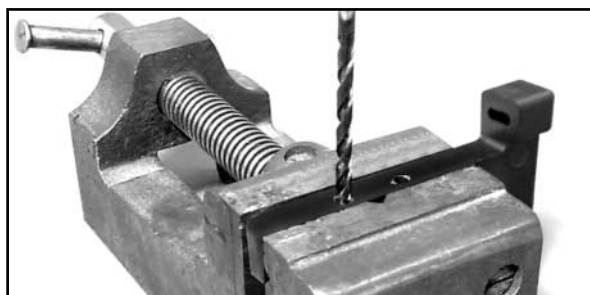

□ 8) Re-assemble the engine on the engine mounts. Then bolt the entire engine and engine mount assembly in position on the firewall. Tighten all bolts firmly. We suggest using a little thread lock compound (not supplied) on all the bolt threads to keep them firmly in place.

FUEL TANK

Next figure out how you want to fuel and de-fuel your airplane, in light of the fact that you have a full cowling surrounding the engine. There are basically two choices.

Method 1

You can use traditional 2-line plumbing inside your tank, along with an after market fueling valve. The 2-line plumbing has a fuel feed line with clunk and a vent line to the top front of the tank.

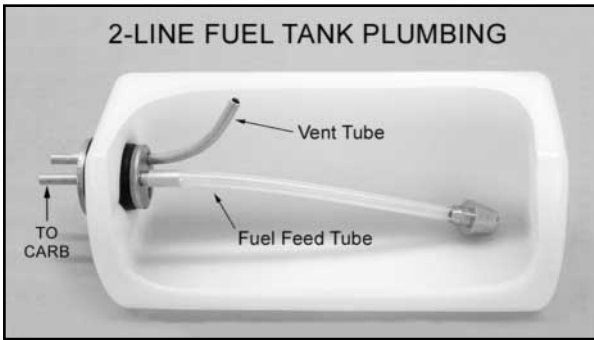

We've used and can recommend the Du-Bro #334 Kwik-Fill Fueling Valve (not supplied). The fueling valve is installed in the main fuel feed line, between the tank and the carburetor. You fill and de-fuel the airplane through the valve. Specific instructions will come with the valve. Mount the fueling valve on the firewall, just under the surface of the cowling, using a SIG #SIGSH759 Fueling Valve Bracket (not supplied). Make a 5/16" dia. hole in the cowling, directly over the fuel valve, to allow the fueling probe to be inserted into the valve.

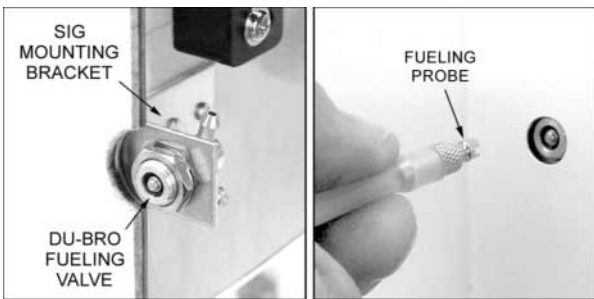

Method 2

You can use 3-line plumbing inside your tank to provide a dedicated 3rd line for filling and de-fueling. The 3rd line is bent down to just reach (but not touch) the bottom front of the tank. This is the line that you will hook up to your fuel pump to fill and empty the tank. This line must be capped after filling to keep the fuel from siphoning back out of the tank. You can cap it with a simple bolt of the correct size, or with an after market "fuel dot".

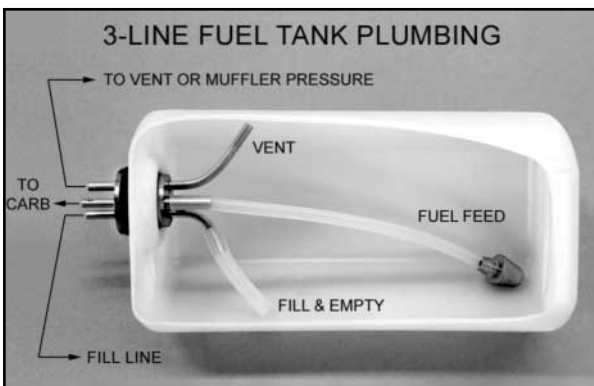

Note in the photos that the correct orientation of the fuel tank body in the airplane is with its neck towards the top of the tank.

TANK ASSEMBLY

❑ 1) Inside the tank is a piece of flexible fuel line tubing. Reach inside the tank with a tweezers or needle nose pliers to get a hold of the fuel line tubing and pull it out. CAUTION: Don't squeeze too hard and put a hole in the tubing! Now shake the tank a few times to make sure there is no dirt or plastic shavings inside!

❑ 2) Take a close look at the rubber stopper. Notice that it has two open holes and one closed one.

a) Assemble the front metal clamp, the rubber stopper, and the rear metal clamp with the bolt. Screw the bolt in, from the front,

just enough to hold the front and rear clamps loosely against the rubber stopper. Do not tighten the bolt at this point. Rotate the front and rear metal clamps until their holes line up with the two open holes in the rubber stopper. You should be able to see daylight completely through the two holes.

b) Using the two shortest of the three supplied aluminum tubes, carefully poke the tubes through the two open holes in the stopper assembly. Keep pushing the tubes in until 3/8" of tube sticks out in front of the stopper assembly.

Note: If you are planning a 3-line tank system, you will be using all three of the holes. Use a sharp hobby knife blade to pierce the front wall of the closed hole. Install the 3rd tube in that hole, again with 3/8" of tube sticking out in front of the stopper assembly.

❑ 3) Put the plain end of a #47 drill bit about 1/4" inside the back end of the vent tube. Using the drill bit for leverage, slowly bend the back end of the vent tube upwards at least 45°. Do not put a kink in the aluminum tube.

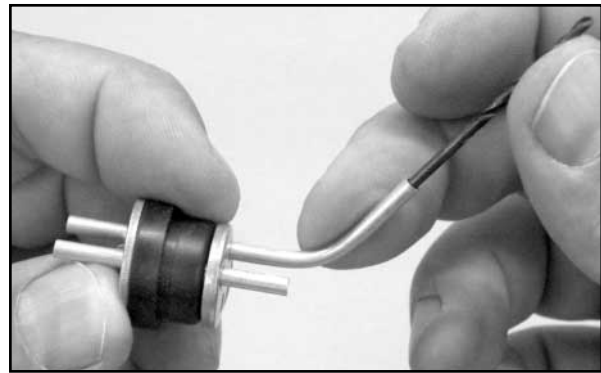

❑ 4) Test fit the completed stopper assembly into the neck of the fuel tank. Hold the tank up to a strong light and look inside to see if the vent tube is close to the top of the tank. If not, take the stopper back out of the tank and adjust the bend in the vent tube as needed. The metal tube should not touch the tank, or vibration may cause it to wear a hole in the plastic tank over time.

❑ 5) Take the stopper back out of the tank. Slide the piece of silicone tubing that came with the tank onto the inside end of the aluminum feed tube. Then add the metal clunk pickup to the other end of the silicone tubing. Test fit the stopper back in the tank to make sure the clunk can swing freely without hitting the back of the tank. If it hits the back end of the tank, shorten the silicone tubing in a small amount at a time until the clunk can swing freely inside the tank.

Note: If you are using a 3rd line for filling the tank, repeat steps 3 and 4 to bend the fill tube towards the bottom of the tank. Make sure it does not actually touch the bottom of the tank.

❑ 6) When everything is right, tighten the screw in the stopper cap until the cap is snug in the neck of the tank. Then test the fuel tank for leaks! Fill your kitchen sink with water. Slip a piece of fuel line tubing onto the tank vent tube. Submerge the tank in the water, holding your thumb firmly over the fuel feed tube. Blow air into the other end of the fuel tubing and watch for air bubbles coming around the cap of the tank. If it's leaking, tighten the screw in the cap a little at a time until the leaking stops.

❑ 7) Trial fit the tank in place inside the fuselage to familiarize yourself with how it mounts. The front of the tank should fit through the hole in the firewall. The main body of the tank is supported by the contoured hole in the fuselage former. Note: If your engine mounting bolts are protruding behind the firewall, it's a good idea to take them out and shorten them so they don't protrude. If they contact the tank, they might dig into the tank and cause a leak in the future. Cut them off or use shorter bolts.

❑ 8) Apply a generous bead of silicone sealer around the neck of the tank (regular household bathroom type silicone sealer, available at most hardware stores, is recommended). Slide the tank in place in the fuselage. Push the tank firmly up against the back side of the firewall, compressing the silicone sealer to make a good seal. If excess silicone sealer oozes out onto the front of the firewall, clean it off.



❑ 9) A 5/16" x 3/4" x 3-3/16" balsa stick is provided to keep the fuel tank in place. Install the balsa stick across the back of the tank, gluing it to the sides of the fuselage. This will keep the tank from sliding backwards in flight. If the tank ever has to be removed for service, you can break the balsa stick loose and get the tank out.

❑ 10) Finish your tank installation by connecting the fuel tank tubes to the appropriate engine, filling valve or fuel dot, fittings, etc. Use only silicone fuel tubing (not included) for all connections. Trim off any excess length of silicone tubing. The fuel lines should be kept as short as possible for best fuel draw, but not so short that there is danger of them coming off in flight. Leave a little slack in the lines.

❑ 11) When using a glow engine it is best to seal the bottom hatch to keep fuel and exhaust residue out of the fuselage. The reason we built a hatch into this airplane was to provide access to the battery compartment when using an electric motor. Obviously, you do not need access to that area. Simply glue the hatch in position, and then seal over the seams with either clear tape or the same color covering material.

COWLING

❑ 1) You will most likely need to make a large opening in the bottom of the cowling to clear the engine cylinder head and carburetor. Don't be tempted to quickly dive in with a knife and start removing large chunks of material. You will achieve a lot better result if you take the time to develop a pattern and mark it on the cowling for guidance when you are cutting.

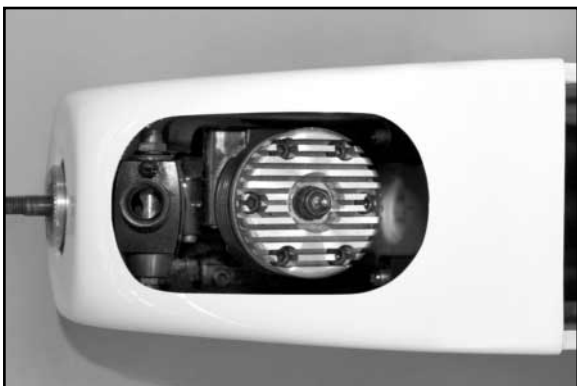

Be aware that there are no hard and fast "rules" for the exact perfect shape for openings in a cowling. Most important, make it big enough to provide the access you need to the engine. The best

method is to "sneak up" on these openings, continually trial fitting the cowling over the engine until it finally fits properly. Once the opening is big enough for you to slip it over the engine and place it in correct location on the model, then continue modifying the opening as needed to provide access to the needle valve and the fuel line tubing at the carb.

Note: A Dremel® Tool, or similar powered hand-tool, with an assortment of sanding bits is without a doubt the best tool to use for making holes in the fiberglass cowling. However, if you do not have access to such a power tool, you can cut the opening with a drill, a hobby knife, and a file - by first drilling a series of almost touching holes inside the pattern lines (1/8" dia. works well); then using the knife to cut through the connecting material between each hole; and finally finishing the edges of the opening with the file or a sanding block.

❑ 2) Mount the cowling on the fuselage with the four M2.6 x 10mm PWA Screws provided.

a) Start by placing the cowl over the engine and in correct position on the front of the fuselage.

b) Mount the spinner backplate on the engine. To hold the backplate in place, mount a propeller on the shaft and hold it in place with a propeller nut (a piece of hardwood with the appropriate size hole drilled in it can substitute for a whole propeller, as in the photo) .

c) Move the cowling back into proper position on the fuselage, leaving a 3/32" to 1/8" gap between the front of the cowling and the back of the spinner, for clearance. Tape the cowling in correct position using a low-tack tape.

d) At the rear of the cowl there are four small pre-drilled mounting holes - two on each side of the airplane. Use a 1/16" drill bit to make a guide hole through one of the cowl mounting holes and into the fuselage side. Install an M2.6 x 10mm PWA Screw into the drilled hole and screw it in place - do not over-tighten the screw. Recheck the overall fit of the cowl and make any adjustments needed with tape to hold it in place. Then on the opposite side of the fuselage, drill another 1/16" guide hole and install a screw into that hole. Repeat this process for the remaining two cowl mounting holes. Remove the tape.



❑ 3) Make additional holes in the cowling as needed for your muffler and to access the engine's needle valve.



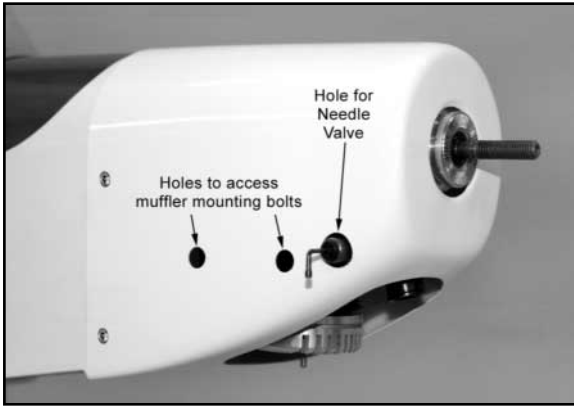

- ❑ 4) Remove the cowling and set it aside for now, while installing the throttle pushrod.

THROTTLE PUSHROD

Locate the following parts from the kit contents:

- ❑ (1) Nylon Outer Pushrod Sleeve (already in the fuselage)
- ❑ (1) 1/8" od x 16" Nylon Inner Throttle Pushrod Tube
- ❑ (2) M2 x 7/8" Threaded Studs
- ❑ (2) Metal R/C Links

Note: Most 2-stroke engines provide low throttle when the throttle arm is pulled fully back toward the rear. High throttle is forward. Check your carburetor and confirm the correct direction of travel for "low" and "high" throttle movement and then check the throttle servo to be sure it also moves in the right direction.

- ❑ 1) Install your throttle servo in the fuselage, using the rubber grommets and screws that came with the servo. Mount the servo in the front opening in the servo tray, lengthwise across the fuselage. For a 2-stroke engine like ours, the servo arm should be towards the left side of the airplane, as shown in the photo below.
- ❑ 2) The outer sleeve for the throttle pushrod is already installed in the fuselage, but not glued. Position the sleeve so the servo end is approximately 1/4" behind the fuselage former that is right in front of the throttle servo. Then glue the sleeve to the former.
- ❑ 3) Screw a M2 threaded stud into one end of the 1/8" od x 16" nylon inner pushrod tube - thread it in at least 1/4" or more. Then screw an R/C link halfway onto the stud. NOTE: If the stud screws into the plastic tube too easily, not getting a good "bite" in the plastic, put some epoxy glue or medium CA on the threads and in the end of the tube before screwing it in.
- ❑ 4) Insert the unprepared end of the nylon inner pushrod tube inside the pushrod sleeve, starting at the servo end inside the fuselage. Slide the inner pushrod tube all the way forward until you can snap the R/C link into the last outermost hole of the throttle servo arm. Note: You will need an extra long or adjustable arm on the throttle servo, so that the outermost hole is in line with the pushrod sleeve.



- ❑ 5) Finish the engine end of the throttle pushrod as follows:
 - a) Turn on your radio system and move the transmitter throttle stick to full high throttle position.
 - b) Clip an R/C link and threaded stud into the bottom hole of the carburetor throttle arm.
 - c) Put the carburetor in full high throttle position.
 - d) Use a marker pen to mark the nylon pushrod tube where it should be cut and still accept 1/4" of the threaded stud.
 - e) Use a sharp blade to cut the pushrod tube at the mark.
 - f) Take the R/C link and threaded stud off the carburetor throttle arm. Screw the end of the threaded stud at least 1/4" into the end of the nylon pushrod tube.
 - g) Reattach the R/C link to the carburetor.
 - h) Turn on the radio system and test the operation of the throttle pushrod and carburetor. Use the EPA (End Point Adjustment) feature of your transmitter to accurately dial-in the desired amount of pushrod travel. Make adjustments to one or both of the R/C links until you can achieve full range of throttle movement. Also make sure there is no binding in the throttle linkage, which could cause unnecessary battery drain.

The installation of your glow engine is now completed. Skip the next section on electric motors and proceed directly to "Attach The Tail Surfaces" on page 14.

ELECTRIC MOTOR INSTALLATION

If you are going to use an electric motor system in your RASCAL 72 EG, you will need to acquire these items (not supplied):

- ❑ (1) Electric Motor and suitable Propeller
- ❑ (1) Motor Mount
- ❑ (1) set of suitable Mounting Bolts and Blind Nuts
- ❑ (1) ESC (Electronic Speed Control)
- ❑ (1) Battery Pack
- ❑ (1) set of Connectors (Battery-ESC)
- ❑ (1) 3/4" wide Hook-and-Loop (Velcro®) sticky-back Tape
- ❑ (1) 3/4" wide Hook-and-Loop (Velcro®) Strap

There are literally dozens of good electric motors and accessories on the market that are suitable for flying the RASCAL. All of them have their own unique features and dimensions, making it impossible to write detailed instructions for every brand. As mentioned in the beginning of this manual, we will be installing a Maxx Products #HC3528-1000 brushless outrunner electric motor, with the Maxx Products #ACC3958 Motor Mount, and a Castle Creations ESC. Even if you use other brands, the following instructions should provide you with enough guidance to successfully install your electric power system.

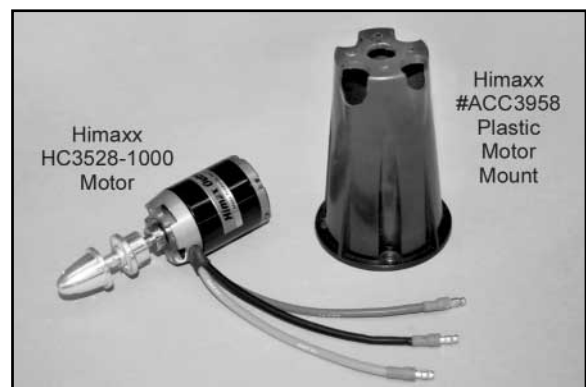

IMPORTANT NOTE ON MOTOR MOUNTS: If you are using a different brand electric motor or motor mount, you need to make sure that the combination you select can provide exactly 4-1/2" distance from the front of the prop adaptor to the front of the firewall (i.e. back of the mount). 4-1/2" is the distance needed for the cowling to fit properly.

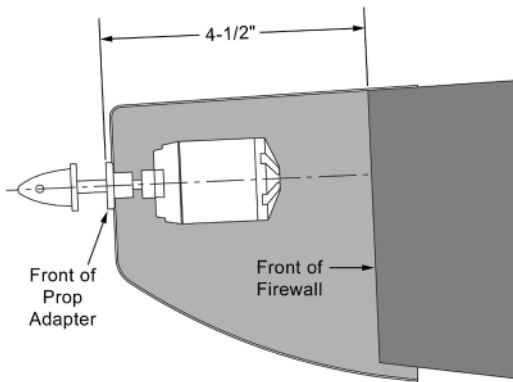

□ 1) There are four sets of “cross-hairs” etched on the front of the plywood firewall to mark the locations of the mounting holes for the Maxx Products #ACC3958 Motor Mount. To install this mount on the firewall you will need to purchase (4) 4-40 x 1/2” Socket-Head Bolts, (4) #4 Flat Metal Washers, and (4) 4-40 Blind Nuts. Drill the four mounting holes with a 9/64” or #27 drill bit.

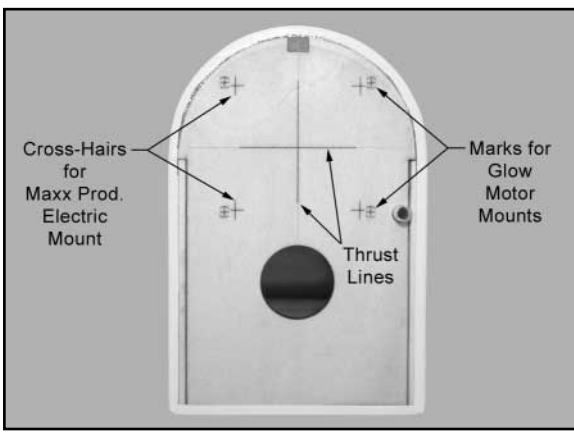

NOTE: If you are using a different mount, line your mount up on the firewall according to the horizontal and vertical thrust lines that are etched in the plywood. Then drill appropriate holes where needed for your mounting bolts.

□ 2) Install the blind nuts on the back of the firewall. The best method is to use one of your mounting bolts, with a flat washer on it, from the front side of the firewall to “draw” the blind nut into the back side. Keep tightening the bolt until the prongs of the blind nut are completely locked into the plywood. After you get all four blind nuts in place, apply a little glue around the flanges of the blind nuts to keep them from coming loose. Be careful not to get any glue in the threads of the blind nuts.

HELPFUL HINT: It's never easy putting a blind nut on the backside of the firewall of a pre-built model. Here's a handy trick! Take a stick of scrap balsa wood - 1/4" sq. x 10"-12" long works well in most cases - and put a piece of doubled-up tape on the end, and then stick the blind nut to the tape. With this stick you can reach inside the nose of the airplane and hold the blind nut in position while you screw in the mounting bolt from the front of the firewall. If the model structure doesn't allow a straight shot at the location, cut an angle on the end of the stick to allow you to hold the blind nut at the correct angle.

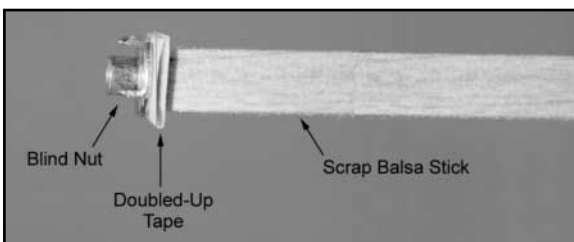

□ 3) Additional holes are needed in the firewall to allow air to flow back inside the fuselage to cool the battery and the ESC in flight. We recommend drilling three new 3/8” dia. holes in the lower part of the firewall, as shown in the photo. These three new holes, in addition to the laser-cut hole that is already in the firewall, should provide enough cooling air flow to keep the battery pack and ESC cool in flight. An electric drill with a 3/8” dia. drill bit is the simplest way to make these new holes.

Note: If using the plastic Maxx Products #ACC3958 Motor Mount, we recommend that you also make a new 7/8” dia. hole right at the intersection of the thrust lines, as shown, which will be directly behind the motor mount. This hole will allow air that flows into the front of the plastic mount to continue on back into the fuselage, where it will eventually exit the airplane near the tail. This will keep the motor cool in flight.

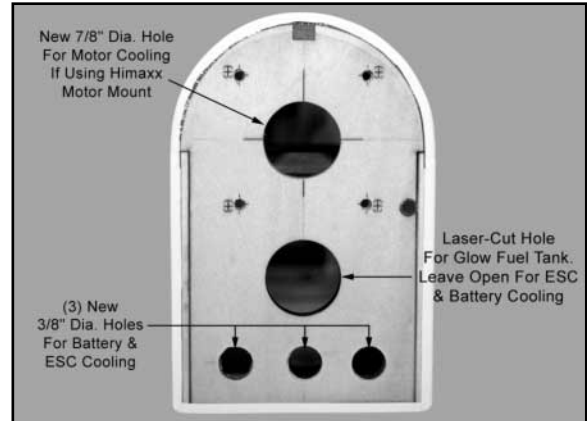

□ 4) The cooling air must have a place to exit the fuselage. There is an opening already cut in the fuselage bottom wood for this purpose. You will have to remove the white covering material to open this hole. The hole is located approximately 11-1/2” from the end of the fuselage - see photo. You should be able to easily make out the edges of the hole by sight and feel. Using a sharp new blade in your hobby knife, carefully cut the covering away over the hole. After removing the covering, seal and toughen the edges of the bare balsa wood with a coat of Thin CA glue.

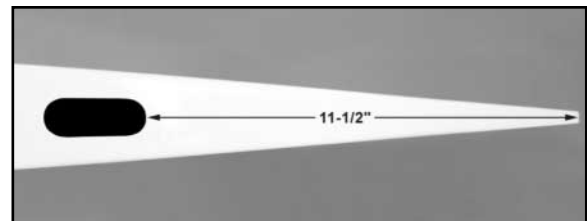

□ 5) Bolt your motor and mount to the firewall. Use thread lock compound (not supplied) on all the bolt threads.



□ 6) Install your Speed Controller (ESC).
a) Solder appropriate connectors (not supplied) to the battery leads of your ESC.

b) Insert your ESC up inside the nose of the airplane, in the area above the built-in plywood battery tray.

c) Pass the motor leads of the ESC through the firewall and connect the leads to the motor. Operate the motor and check the direction of rotation. If you need to reverse the rotation, refer to the instructions that came with the motor and ESC.

□ 7) Put a strip of 3/4" wide hook-and-loop tape (commonly called Velcro® - not supplied) on the battery compartment floor. Put a strip of the mating tape on each of your battery packs. This will keep your battery pack from shifting position in flight.

Note: Hook-and-loop "tape" has either the hook or the loop on only one side of the strip. The other side is sticky back.

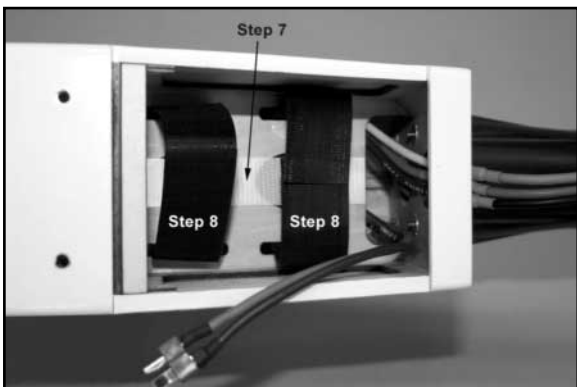

□ 8) Cut two 9" long pieces of 3/4" wide hook-and-loop strap material (commonly called Velcro® - not supplied). Install the two straps in the battery compartment as shown, running them through the slots in the plywood floor. Anchor the straps to the backside of the plywood with a few drops of glue. These straps will keep your battery pack from falling out of the airplane.

NOTE: Hook-and-loop "strap" has the hook surface on one side of the strip and the loop surface on the other side. You can overlap the ends of the strip and stick them together, effectively creating a strap to hold your battery pack securely in position.

□ 9) Mount the cowling to the fuselage with the four M2.6 x 10mm PWA Screws provided. Note that four holes for the screws are already in the cowling - two on each side. Tape the cowling in correct position on the fuselage, using a low-tack tape. Use a 1/16" drill bit to make a guide hole through one of the upper cowl mounting holes and into the fuselage side. Install an M2.6 x 10mm PWA Screw into the drilled hole and screw it in place - do not over-tighten the screw. Recheck the overall fit of the cowl and make any adjustments needed with tape to hold it in place. Then on the opposite side of the fuselage, drill another 1/16" guide hole and install a screw into that hole. Repeat this process for the remaining two cowl mounting holes. Remove the tape.



□ 10) **COOLING IS IMPORTANT!**
With a fully cowled in electric motor, it is very important to make sure your power system is getting proper cooling. You must have

air flowing into the front of the cowling and then out the back. This air flow keeps your motor running cool. Previously in Step 3 of this section we made 3 additional holes in the firewall to allow the cooling air to flow from the cowling into the fuselage and past the battery pack and ESC. In Step 4 we made a hole in the bottom of the rear fuselage to finally let the air back outside of the airplane. This flow of air through the entire length of the fuselage is vital to good performance of your electric power system.

The exact size and shape of the holes you should make in the front of the cowling is a matter of personal preference, cosmetically. A round hole(s), square hole, or slots - it's your choice. We made three slots in the bottom of our prototype cowling, as shown. The slots are approximately 3/8" wide and 1-5/8" long.



OPTIONAL SPINNER: A 2-1/4" dia. plastic spinner is included in this kit. No doubt it will be used by almost everyone who is installing a glow engine. However with an electric motor you may prefer to not use the spinner in order to allow additional cooling air to flow into the cowling. The opening between the prop shaft and the cowling (which a spinner would cover up) allows a significant amount of air to flow directly onto the motor.



However, this does not mean that you cannot use a spinner on this airplane. Many people do successfully use big spinners on fully cowled electric motors. You simply need to make some additional openings in the front of the cowling for cooling air to enter, perhaps a couple more slots in the top of the cowling, as shown.

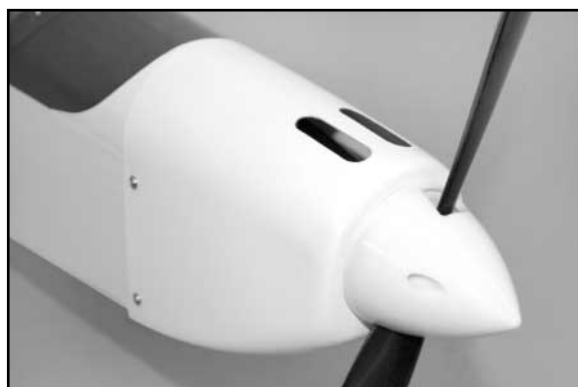

Also make sure you have plenty of exit area for the air to flow out of the cowling. In any fully cowled installation (glow or electric), it is critical that you have slightly more exit area than incoming area. Having more exit area creates a positive air flow through the cowling - an actual suction effect - drawing the heated air out of the cowling so that more cool air can come in.

ATTACH THE TAIL SURFACES

Both glow engine and electric motor users resume assembly here.

Locate the following parts from the kit contents:

- (1) Stabilizer and Elevator assembly
- (1) Fin and Rudder assembly

Note that the elevator hinges are glued in at the factory. Flex the elevators up and down a few times to free their movement. However, the rudder hinges are not glued. That will be done during the assembly steps.

1) Bolt the wing in place on the fuselage. Place the model on a flat surface and orient it to allow you to view the airplane from the front from a distance of 10 feet or so.

2) Trial fit the stabilizer/elevator assembly on the fuselage, without glue. Use a couple pins to hold it in position. Use a tape measure or yardstick to measure the distance from the rear corner of the stab straight ahead to the wing. Then, take the same measurement on the other side of the fuselage. The two measurements should be identical or within 1/8" of each other. If not, unpin the stabilizer and shift it as needed to get the two measurements the same. Once you have it squared up, use a fine felt tip marker to give yourself some guide marks at the front and back of the stab, so you can quickly realign it later when glue is applied.

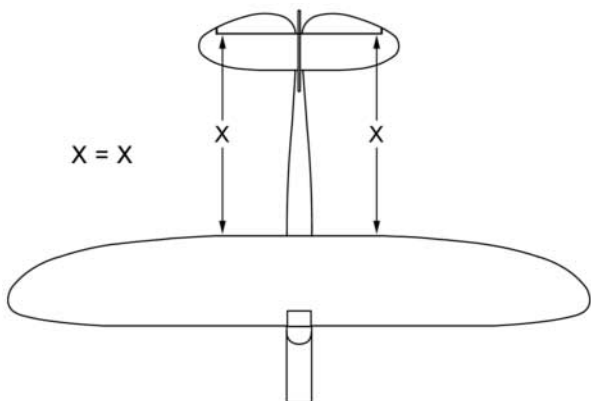

3) Also check the alignment of the stabilizer from the front view. With the stabilizer squarely in place and pinned, view the airplane from the front and rear. The stabilizer should be equally aligned with the wing - not tilting one way or the other. If it is tilting, correct it. When satisfied with the alignment, remove the stabilizer from the fuselage in preparation for gluing on permanently.

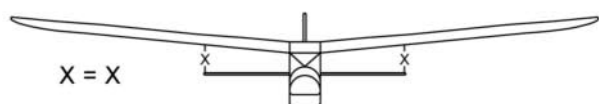

4) We recommend gluing the stabilizer permanently onto the fuselage with slow-drying epoxy glue, which will provide plenty of time to get the stabilizer properly realigned with the fuselage and wing. Mix a batch of epoxy in sufficient quantity to cover the area of the fuselage where the stabilizer goes. Spread the glue evenly over the exposed wood of the stabilizer saddle. Carefully set the stabilizer back in position on the saddle. Press the stabilizer down firmly and pin it in correct position. Quickly recheck the alignment

in both the top and front views before the glue dries. Use a paper towel and rubbing alcohol to wipe off any excess glue that oozes out of the joint. Let this joint dry completely before proceeding.

5) Remove the rudder from the fin. The rudder will be hinged later. Trial fit the fin on the fuselage, without glue, making sure that the bottom of the fin sits flat and in full contact to the stabilizer. Trim or sand the bottom of the fin tab until the fin sits fully in place on top of the stabilizer.

6) Hold the fin in place and use a sharp pencil to trace around the front, where it extends forward of the stabilizer and on to the top of the fuselage. Remove the fin and use a sharp hobby knife to cut and remove the covering from just inside of the pencil marks.



7) Apply epoxy glue to the bottom of the fin, including the tab that fits into the slot in the stabilizer. Press the fin in place into the top of the stabilizer slot and wipe off any excess glue with alcohol. Use strips of tape and/or pins to hold the fin in correct position. Double check the alignment of the fin - it should be perpendicular (90°) to the stabilizer. Adjust the tape as needed to hold it in position. Use alcohol and a paper towel to wipe off any excess glue. Allow the glue to dry completely.

8) From the kit contents, locate the bag containing the tailwheel assembly. Remove the metal 3-arm rudder steering horn and two M2 x 10mm PWA screws used to mount the horn to the bottom of the rudder, as shown. Position the front edge of the horn 1/8" behind the leading edge of the rudder. Begin by using the rudder steering horn as a template to first mark the locations for the screw holes. Then use a 1/16" drill bit to make two pilot holes into the bottom of the rudder. Secure the horn in place with the screws.

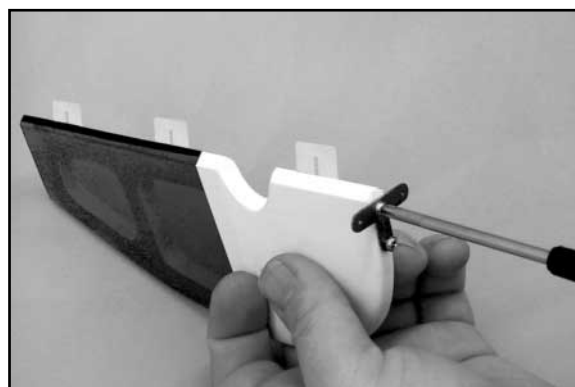

9) The rudder is now hinged to the vertical fin and fuselage.

- a) Slide the three CA hinges in place into the slots in the rudder, centering them. Use pins in the center of each hinge to keep them centered during the next step.
- b) Now carefully slide the exposed half of the hinges into the slots in the back of the fin and fuselage. Adjust the rudder position and then remove the pins.
- c) To set the proper amount of gap between the fin and rudder,

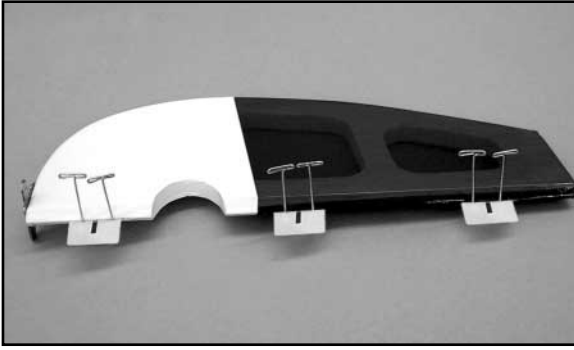

simply deflect the rudder to the maximum amount of travel needed. This will automatically set the proper hinge gap! Keep in mind that for best control response the gap should be kept as small as possible, but big enough to allow full movement of the control surface. Make sure everything is functioning properly before proceeding to the next step.

d) Hold the rudder over to one side while you apply 3 - 4 drops of Thin CA glue directly onto the hinge in the gap. You will notice that the glue is quickly wicked into the slot as it penetrates both the wood and the hinge. Turn the part over and glue the other side of the hinge. Continue this process until you have glued both sides of all three hinges. Keep a rag handy to wipe off any excess Thin CA glue. (If you get some glue smears on the plastic covering, don't worry about them right now. Once all the hinging is done, you can clean the smears off the covering with CA Debonder). Let the glue dry a minimum of 15 minutes before flexing the hinges.



VERY IMPORTANT: It's critical that you only make one application of glue to each side of a CA Hinge. If you apply additional glue to the hinge after the first application of glue is already dry, the second application of glue will merely puddle in the hinge gap and make the hinge too stiff to operate properly. When properly glued, the portion of the hinge that you can see in the hinge gap should have a dry appearance, not wet. Two to three good size drops of Thin CA should be about the right amount. NEVER USE CA ACCELERATOR ON CA HINGES!

LANDING GEAR

TAILWHEEL

Locate the following parts from the kit contents:

- (1) Leaf-Spring with Tailwheel & Steering Arm
- (3) M2.6 x 12mm PWA Screws
- (2) Coil Steering Springs

1) Mount the leaf-spring assembly in place on the bottom rear of the fuselage.

- a) First drill 1/16" dia. pilot holes for the three mounting screws.
- b) Then screw the assembly in place with the M2.6 x 12mm screws provided.

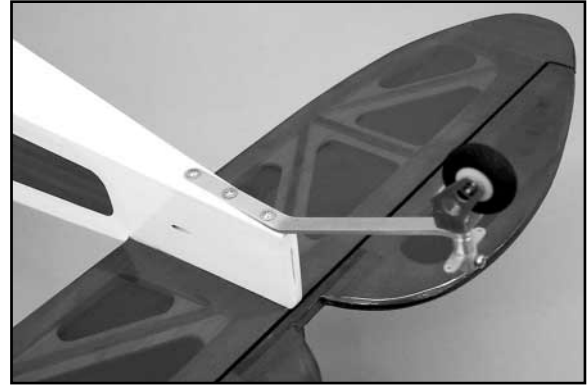

- 2) Install the two coil steering springs between the steering arm on the bottom of the rudder and the steering arm on the leaf-spring assembly. Install the two springs as shown, making sure the tailwheel is facing exactly forward when the rudder is in neutral. When installed the springs should be under slight tension, not loose.

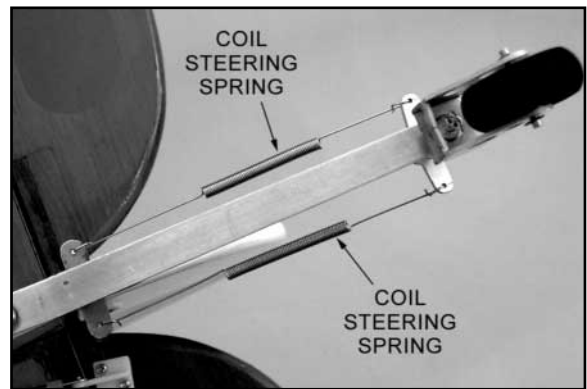

MAIN LANDING GEAR

Locate the following parts from the kit contents:

- (1) Formed Aluminum Landing Gear
- (2) 2-3/4" dia. Main Wheels
- (1) Right Wheel Pant
- (1) Left Wheel Pant
- (4) M3 x 8mm Bolts for wheel pant mounting
- (4) M3 Split Ring Washers for wheel pant mounting
- (2) M4 x 40mm Bolts for axles
- (4) M4 Lock Nuts for wheel mounting
- (4) M4 Flat Metal Washers for wheel mounting
- (2) M4 x 20mm Bolts for landing gear mounting
- (2) M4 Split Ring Washers for landing gear mounting

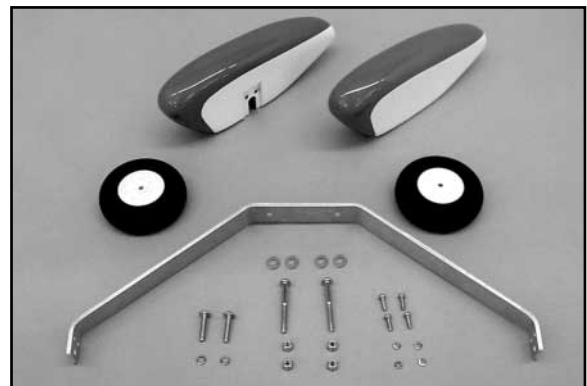

1) Mount the wheels onto the aluminum landing gear.

- a) First slide one of the M4 x 40mm axle bolts through one of the wheels. Then thread a M4 lock nut onto the threaded end of the axle bolt and run it all the way up to the wheel hub. Leave just

RADIO INSTALLATION

a little “play” to allow the wheel to rotate freely.

b) Next put two flat metal washers on the axle, up against the lock nut. These will serve as spacers to get the wheel in the center of the wheel pant.

c) Now poke the threaded end of the axle bolt through the bottom hole in the aluminum landing gear.

d) Last, thread another M4 lock nut onto the axle, tightening it up against the landing gear.

e) Repeat steps a) through d) to mount the remaining wheel on the opposite landing gear leg.

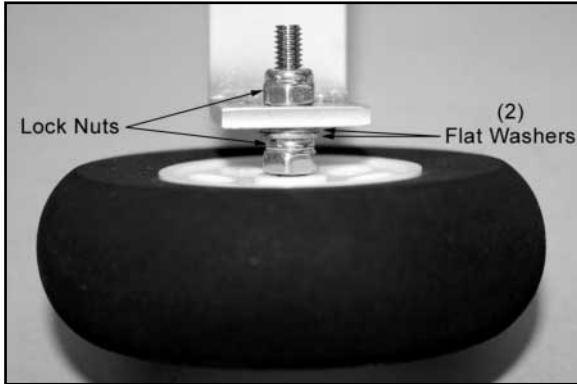

□ 2) Mount the wheel pants onto the aluminum landing gear. *Before beginning note that there is a front and rear edge to the aluminum landing gear. In the side view, the landing gear legs are canted slightly forward. Be sure to mount the landing gear and the self-aligning wheel pants in the correct direction!*

a) Slip the wheel pant over the top of the wheel and slide it down in place over the wheel and onto the inner M4 lock nut. Doing this should line-up the holes in the aluminum landing gear with the holes in the wheel pant.

b) Use two M3 x 8mm bolts with M3 split-ring lock washers to mount the wheel pant to the landing gear leg. Check the wheel for free rotation.

c) Repeat this procedure to mount the remaining wheel pant on the opposite landing gear leg.



□ 3) The completed landing gear is now mounted to the fuselage using two M4 x 20mm bolts and split ring lock washers. Be sure to use a little thread-locking compound on the threads and snug the bolts in place firmly.

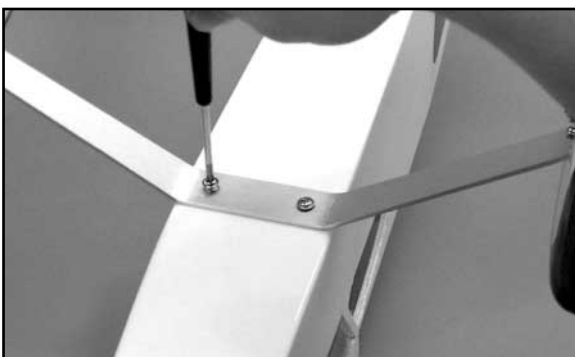

The aileron servos and the throttle servo (glow only) are already installed and ready to use. The rest of the radio installation consists of mounting the elevator and rudder servos in the fuselage, along with the receiver, battery pack, and switch.

ON/OFF SWITCH

The switch can be mounted in any position provided its leads can reach the receiver and battery pack.

External Mount: The switch can be mounted directly into the side of the fuselage, using the hardware and plastic parts that are included by the radio manufacturer. Typically, an externally mounted switch is placed on the left side of the fuselage. For glow engine powered airplanes, you definitely want the switch on the side away from the exhaust. Start by using the switch cover plate as a template to mark the location of the two mounting holes and the opening needed for the switch to operate. Be sure there is solid sheet balsa under the covering in the area you are putting the switch. Use a modeling knife to cut the opening. Use a 1/16" dia. drill to make the holes for the bolts. Install the switch.

Internal Mount: Some flyers prefer to mount the switch internally, to keep it away from dirt and fuel. If you wish to mount your switch inside the fuselage, you can simply stick it to the floor with double-sided servo tape (not supplied). Bend and install a push/pull wire that extends out of the fuselage side. To do this, just drill a 1/16" dia. hole through the top of the switch lever and use a piece of 1/16" dia. music wire to activate the switch.

ELEVATOR & RUDDER SERVOS

Mount the elevator and rudder servos in the plywood servo tray using the screws and rubber grommets that came with your radio system. The elevator servo should be mounted in the right rear opening of the servo tray. The rudder servo should be mounted in the left rear opening. Be sure to drill pilot holes in the plywood servo tray before trying to screw the servo in place.

RECEIVER

Following the radio manufacturer's instructions, plug all the wires for the servos, battery pack, and switch harness into the receiver so the radio system is fully operational. Double check to be sure that each servo is plugged into its correct receiver terminal and that it is responding properly.

If you are using glow power, wrap the receiver in a single layer of 1/2" thick soft foam rubber to insulate it from vibration and shock. Use tape or rubber bands to hold the foam around the receiver. Stuff the receiver directly beneath the servo tray and use additional foam, or a plastic “cinch” strap, to hold it in place.

Receiver antennas come in all shapes and sizes since the advent of 2.4ghz radio systems. Secure your antenna in the airplane as recommended by your radio manufacturer.

RECEIVER BATTERY PACK

If you are using a receiver battery pack (all glow and some non-BEC electric motor installations) wrap the battery pack with a single layer of 1/2" thick soft foam rubber to insulate it from vibration and shock.

For now, leave the receiver battery pack loose on the bottom of the fuselage in front of the servos. Later, when the Center of Gravity (CG) is established, the final position of the battery pack will be determined.

ELEVATOR AND RUDDER PUSHRODS

The nylon outer pushrod sleeves have already been installed in your model. What remains is to make the nylon inner pushrods to connect from the servos to the rudder and elevators.

Locate the following parts from the kit contents:

- q (2) 1/8" dia. x 25-1/2" Nylon Inner Pushrod Tubes
- q (4) Metal R/C Links
- q (4) M2 Threaded Studs
- q (2) Nylon Control Horns
- q (4) M2 x 20mm Bolts

□ 1) Mount a nylon control horn on the bottom of the elevator with two M2 x 20mm bolts and a nylon control horn base. The elevator control horn goes on the right side of the airplane, the same side as the elevator servo.

a) Start by holding the control horn in place on the bottom of the elevator. Make sure it is all the way forward so that the holes in the arm line up with the hinge line. Use a pencil or pointed tool to mark the location of the two mounting holes onto the elevator.

b) Drill a 5/64" or 3/32" dia. hole at both of the marks, all the way through the elevator.

c) Poke two M2 x 20mm bolts through the control horn, and then through the elevator.

d) As the bolts come through the top of the elevator, engage the bolt ends into the holes in the nylon control horn base. Tighten the bolts until the horn and the base are both up against the elevator. Do not over-tighten and crush the wood.

e) Use diagonal cutting pliers to trim-off the excess exposed ends of the bolts.

□ 2) Mount a nylon control horn on the left side of the rudder with two M2 x 20mm bolts and a nylon control horn base, using the same techniques you did in the previous step for the elevator horn. Make sure to line it up with the rudder pushrod exit hole in the fuselage side.



□ 3) Assemble and install the ELEVATOR PUSHROD.

a) Install one of the M2 threaded studs into one end of a 25-1/2" nylon inner pushrod tube. Thread the stud into the tube at least 1/4". Thread a metal R/C link onto the stud, centering the threads to allow equal adjustment in either direction.

b) Slip the opposite end of the pushrod tube into the outer pushrod sleeve inside the fuselage - on the right side for the elevator servo. Slide it all the way towards the back until you can clip the R/C link into the outermost hole in the elevator servo arm.

c) Turn on your radio system and check the action of the elevator servo and pushrod up to this point. It should work smooth and easy. If not, find the source of the trouble and fix it now. It won't get any better as you go along.

d) Make sure the elevator servo is in neutral position when the transmitter stick and trim lever are neutral, and then turn the radio off.

e) At the tail end, clip another M2 threaded stud with R/C link into the bottom hole of the elevator control horn. Line-up the threaded stud with the pushrod tube and mark the tube where it should be cut to accept 1/4" of the exposed threads of the stud.

f) Cut off the inner pushrod tube at the mark made in the previous step.

g) Screw the threaded stud with R/C link into the end of the pushrod tube.

h) Turn your radio system back on and check the neutral position of the elevator. Adjust one or both of the R/C links as needed to get it in neutral position.



SAFETY ISSUE: After centering the servo, "safety" each R/C link by slipping a short length of fuel tubing (not supplied) over the link, as shown in many of the photos. This will eliminate any chance of the link opening up in flight and becoming disconnected from either the control horn or the servo arm. Do this for ALL R/C links in the airplane!

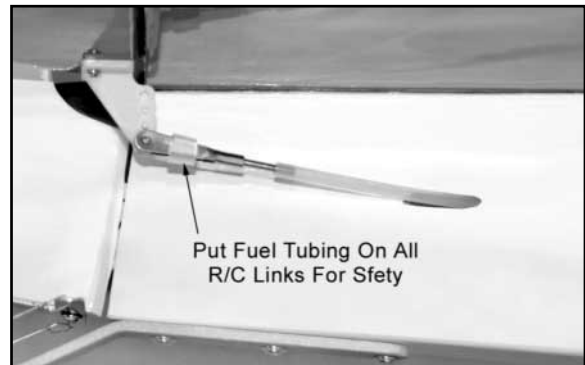

□ 4) Repeat Step 3 to install the RUDDER PUSHROD.



□ 5) When finished, double check to make sure you have re-installed the screws that hold the servo arms to the servos.

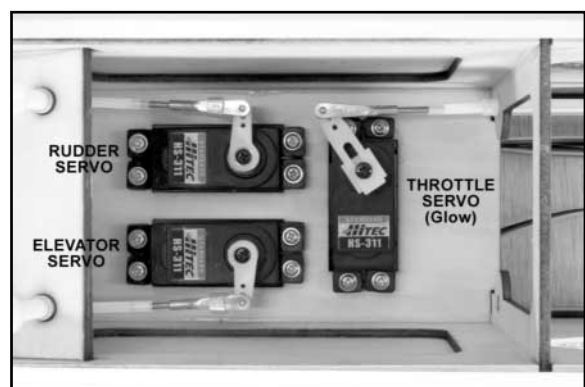

CONTROL SURFACE TRAVEL

The following control surface travel amounts will provide your RASCAL with smooth, predictable flight characteristics. We suggest that you start with these movements and adjust them later to suit your particular style of flying. Note that all measurements should be taken at the widest part of the surface at the trailing edge.

AILERONS: 3/4" UP - 3/4" DOWN
ELEVATORS: 3/4" UP - 3/4" DOWN
RUDDER: 1" LEFT - 1" RIGHT

INSTALL SIDE WINDOWS

From the kit contents, locate the molded clear plastic side windows. The windows are molded to fit into the fuselage window frames from the inside. Use scissors to cut out each window, leaving about 1/8" plastic flange around the outside edges for a gluing surface.

We suggest using 5-minute epoxy or RC-56 glue to mount these windows. Do not use thin CA glue - it may fog up the plastic! Apply a thin bead of glue around the edges of the plastic window and press it in place from the inside of the fuselage. Use a few small pieces of tape to hold the window in place until the glue sets.

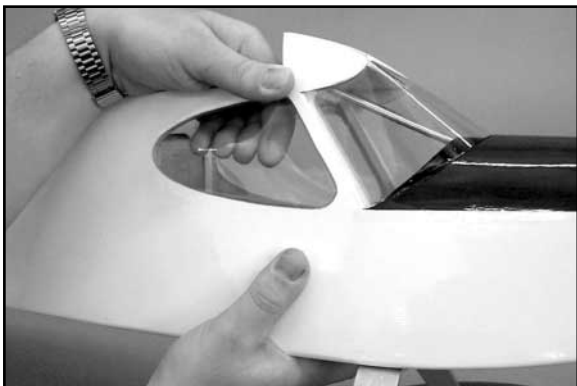

DECAL APPLICATION

The decals supplied in this kit are sticky-back, with a very aggressive adhesive. They are NOT water-activated! These decals need to be cut from their sheets with a sharp hobby knife or scissors. A straight edge makes this easier when straight lines are involved. Trim as close to the image as possible.

In the case of the large door frame outline, we suggest that you cut this decal out on both sides of the frame outline, in one piece. If you are careful, application of this large decal is not as difficult as it sounds, if you use the method described below.

The best way to put on sticky-back decals, especially large ones, is using the "wet" method. This technique involves using a "soapy water" mixture to float the decal on the surface of the model until you get it in correct position, and then use a squeegee to press the decal permanently in place.

The soapy water mixture can simply be water mixed with a very small amount of dish soap, or SIG Pure Magic Model Airplane Cleaner, or Fantastic®, or Windex®, or 409® type household cleaners - they all work great. For a squeegee, we recommend the SIG 4" Spreader #SIGSH678, or simply use some scraps of sheet balsa. You will also want to have some soft paper towels or clean soft cloths (old tee shirts are great) handy.

First, spray the surface of the model where the decal is to be placed with a soapy water mixture. Then, carefully peel the decal completely off the backing sheet, being careful not to let the sticky side double over and adhere to itself. Then, spray the adhesive side of the decal as well. Lightly position the decal in place on the wet surface of the model. Do not push down! The liquid allows you to slide the decal into the desired final position, as long as you don't press down on it. Once you have it in position, gently squeegee the excess liquid out from under the decal, starting from the middle and working out towards the edges. Mop up the liquid with a dry cloth. Squeegee repeatedly to get as much of the water out from under the decal as possible. Allow the decals to set overnight to finish drying. Once dry, they will be solidly adhered to the model.



CONGRATULATIONS!

Your RASCAL 72 EG is completely assembled. However, it is NOT ready for flight! There are a few very critical pre-flight tasks we must perform before flying. These are extremely important and should be approached with patience and care.

BALANCE YOUR AIRPLANE

This may be the single most important step in preparing your airplane for flight. All airplanes, model or full-size, must be accurately balanced in order to fly successfully. An airplane that is not properly balanced will be unstable and will most likely crash.

NOT ALL RASCALS WILL BALANCE THE SAME

It is impossible to produce a model airplane kit that will automatically have the correct balance point. Not everyone uses the same engine/motor or radio gear - and all those items can vary in weight! You might be surprised to know that .40 size 2-stroke R/C engines can vary in weight from 11 oz. to 18 oz. - that's almost a half pound difference, way out on the nose of your model! There can even be as much as a 3/4 oz. difference in weight between different brands of propellers! So, that's why every model must be balanced before flying. Don't feel that whatever the balance point your model came out at is "good enough". Check carefully and make whatever adjustments are required. Trying to fly an out of balance model is dangerous!

Preliminary: All the parts and components that will be in the airplane in flight must be installed in their correct positions. This includes all the radio gear, the propeller, spinner, muffler (if applicable), etc. Every piece of essential equipment must be installed, ready for flight. Always balance a glow powered model with the fuel tank empty. Always balance an electric powered model with the battery pack in place.

RECOMMENDED BALANCE POINT
3-3/8" Behind The Leading Edge Of The Wing
Immediately Next To The Fuselage Side

Using a ruler, measure back from the leading edge of the wing and mark the balance point on the bottom of the wing, next to the fuselage. Make the same marks on both sides of the fuselage. Place your fingertips within the balance range on both sides of the airplane and carefully lift it off the table. No part of the model should be touching anything except your fingertips! If the RASCAL will sit on your fingertips in a level attitude, then it is properly balanced and ready to fly.

If the airplane sits on your fingertips in an extreme nose down attitude, then it is nose heavy. You will have to add weight to the rear of the airplane to get it to balance. NOTE: Before adding additional weight to the model, try simply moving the battery pack to a further aft location. The battery pack is relatively heavy and therefore makes a good balancing tool. You might try switching places between the battery and receiver; or move the battery right in front of the servos; or in extreme situations, move it behind the servos. If you can't get your model balanced simply by re-locating the battery pack, then you will have to purchase lead weights from your hobby dealer and glue them into the tail end of the fuselage.

If the airplane sits on your fingertips with the tail down, it is tail heavy. DO NOT ATTEMPT TO FLY IT! A tail heavy model is very dangerous and will most likely crash!! Weight will have to be added to the nose of the model to bring it into balance. The weights can be glued to the front of the firewall; or inside the cowling. There are also "spinner weights" available for tail heavy models. Wherever you put the balancing weight, make sure it cannot come loose in flight!

FLYING

When it comes to test flying a new model, we always advise modelers to choose a calm day with little or no wind. These conditions allow you to better evaluate and more accurately adjust the trim requirements for your airplane. As we've mentioned before, a good running, reliable motor is a must for the ultimate success of your airplane. Take the time to solve any power system problems before you try to fly.

Always make it part of your pre-flight routine to check each control on the airplane, making sure the surfaces are moving in the correct directions. Also check each control linkage to be sure they are secure and that nothing is loose. With all the controls checked, make a range check with your radio system, making sure everything is working perfectly.

After starting and warming up the engine, taxi the RASCAL out to the take-off position on the flying field, (holding up elevator during the taxi will keep the tailwheel firmly to the ground). For take-off, the airplane should be lined-up with the center of the field with the nose pointed directly into the wind. Hold a little up elevator and smoothly advance the throttle - do not slam the throttle full open all at once. As the RASCAL begins moving forward, back off of the up elevator input and use the rudder, only as needed, to correct any engine torque and/or wind induced deviations from a straight take-off run. Allow the airplane to lift off, using ailerons to keep the wings level. Climb to a reasonable altitude before making any trim changes.

Although not intended as a trainer, the RASCAL is a very forgiving design that allows you to fly at relatively low speeds, giving plenty of time to learn the basics of R/C flight. With the control movements set at the measurements provided in this manual, the airplane should exhibit smooth, predictable control. Try a few loops and rolls. You will find that the roll rate is not especially high at the initial aileron settings but they can be very axial with practice. Inverted flight is easy, requiring surprisingly little down elevator for level flight. The RASCAL also performs nice inside and outside

loops, snap rolls, Immelmann turns, stall turns, Cuban eights, and spins. As with any aircraft, getting consistently good results is a matter of practice. In all of this, we'll bet one of your favorite RASCAL maneuvers will be a long low fly-by - what a great looking airplane!



While still at altitude, throttle the engine back to idle. This will give you a good idea of the glide characteristics. While still at idle, steadily increase up elevator input to get a feel for the stall characteristics. With practice and a little rudder input, the RASCAL can be flown to a virtual standstill before stalling. Stalls tend to be very gentle with one wingtip or the other dropping, followed almost immediately with resumed flight as soon as the elevator is neutralized. This is great information to have when setting up your first landings.

You will find that this airplane has a powerful rudder. As you gain experience and confidence with the RASCAL, you will find that you can get some great cross-control action, including almost sideways flight, side-slips, and flat turns. With a little elevator input and a strong motor, the RASCAL will knife edge very well.

Landing the RASCAL is typically a pleasure. We suggest using a standard landing approach, beginning with a throttled back downwind leg and base turn to the final approach into the wind. During final approach, keep just a little power on the engine until the airplane is exactly where you want it for touchdown. In crosswind situations, a little rudder input will likely be needed to keep the airplane lined up with the runway. The RASCAL can be easily landed on either main wheels or in the three-point position. After landing, always remember to hold up elevator when taxiing to keep the tailwheel firmly to the ground.

We sincerely hope that your RASCAL will provide you with many enjoyable flights. Good luck and safe flying!



With its large wing area and light weight, the RASCAL 72 EG makes a terrific float plane!

WARNING! THIS IS NOT A TOY!

Flying machines of any form, either model-size or full-size, are not toys! Because of the speeds that airplanes must achieve in order to fly, they are capable of causing serious bodily harm and property damage if they crash. **IT IS YOUR RESPONSIBILITY AND YOURS ALONE** to assemble this model airplane correctly according to the plans and instructions, to ground test the finished model before each flight to make sure it is completely airworthy, and to always fly your model in a safe location and in a safe manner. The first test flights should only be made by an experienced R/C flyer, familiar with high performance R/C aircraft.

JOIN THE AMA

The governing body for radio-control model airplanes in the United States is the ACADEMY OF MODEL AERONAUTICS, commonly called the AMA. The AMA SAFETY CODE provides guidelines for the safe operation of R/C model airplanes. While AMA membership is not necessarily mandatory, it is required by most R/C flying clubs in the U.S. and provides you with important liability insurance in case your R/C model should ever cause serious property damage or personal injury to someone else.

ACADEMY OF MODEL AERONAUTICS

5161 East Memorial Drive
Muncie, IN 47302

Telephone: (765) 287-1256

AMA WEB SITE: www.modelaircraft.org

CUSTOMER SERVICE

SIG MFG. CO., INC. is committed to your success in both assembling and flying the RASCAL 72 EG ARF. Should you encounter any problem building this kit or discover any missing or damaged parts, please feel free to contact us by mail or telephone.

SIG MFG. CO., INC.

P.O. Box 520

401 South Front Street
Montezuma, IA 50171-0520

PHONE: 1-641-623-5154

FAX: 1-641-623-3922

SIG WEB SITE: www.sigmf.com

SIG E-MAIL: mail@sigmf.com

LIMIT OF LIABILITY

The craftsmanship, attention to detail and actions of the builder/flyer of this model airplane kit will ultimately determine the airworthiness, flight performance, and safety of the finished model. SIG MFG. CO.'s obligation shall be to replace those parts of the kit proven to be defective or missing. The user shall determine the suitability of the product for his or her intended use and shall assume all risk and liability in connection therewith.

TAKE A LOOK AT THE OTHER SIG RASCAL ARFs!

for GLOW, GAS or ELECTRIC
power!

RASCAL 110

SPECIFICATIONS

Wingspan: 110 in. Wing Area: 1522 sq.in.

Length: 75-3/4 in. Weight: 11 - 13 lbs.

Wing Loading: 16.6 - 19.7 oz./sq.ft.

Recommended Power

2-Stroke: 1.2 - 1.5 cu.in. (20 - 25 cc)

4-Stroke: 1.2 - 1.8 cu.in. (20 - 30 cc)

Gas: 1.2 - 1.8 cu.in (20 - 30 cc)

Electric: 1600 - 2600 watts; 200 - 270 kv



Available in two color combinations ...
White & Transparent Red - #SIGRC84ARFR, or
White & Transparent Blue - #SIGRC84ARFB



5-CHANNEL
WITH OPERATING FLAPS!



BRUSHLESS MOTOR &
SPEED CONTROL INCLUDED!

RASCAL EP-49

SPECIFICATIONS

Wing Span: 49 in. Length: 32-1/2 in. Wing Area: 324 sq.in.

Weight: 22 - 25 oz. Wing Loading: 9.7 - 11.1 oz./sq.ft.

4-CHANNEL - Ailerons, Elevator, Rudder, Throttle

Available in two color combinations ...
White & Transparent Red - #SIGRC107ARFR, or
White & Transparent Yellow - #SIGRC107ARFY