

ASSEMBLY MANUAL



RASCAL 80^{EG}

KIT NO. SIGRC880EGARF

ALMOST READY TO FLY



Fly With Electric Or Glow Power!

Wingspan: 80 in. (2032 mm)
Wing Area: 800 sq. in. (51.7 sq. dm)
Length: 56 in. (1422.4 mm)
Flying Weight: 7-7.5 lbs. (3175 - 3402 g)
Wing Loading: 16-18 oz./sq.ft. (49-54 g/sq.dm)
Radio Required: 4-Channel with 4-5 Standard Servos
Glow Power: 2-Stroke .46-.55 cu.in. (7.5-9 cc)
4-Stroke: .53-.65 cu.in. (9-11 cc)
Electric Power: 600-1100 Watt Brushless Motor
60-80 Amp ESC, LiPo Battery

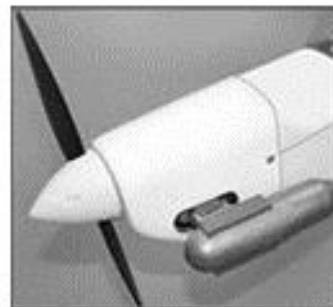

SIG MFG. CO., INC. PO Box 520 Montezuma, IA 50171-0520
800-247-5008 www.sigmf.com



INTRODUCTION

Congratulations on your purchase of the SIG RASCAL 80 EG ARF kit. The legend of the RASCAL began with a small rubber powered free-flight model in the 1950s. Adapted for modern radio control, the RASCAL's classic good looks and dream-come-true flying characteristics have made it the favorite everyday airplane of thousands of R/C pilots.

SIG offers the RASCAL design in several sizes. This 80 inch wingspan version gives you the option of using either glow or electric power. Whichever power system you choose, you'll find that the RASCAL flies as good as it looks. Streamlining and a high performance airfoil allow the RASCAL to do aerobatic maneuvers better than most typical high wing designs. This will very likely become your favorite everyday R/C airplane!

Assembly of the RASCAL 80 EG ARF is fast and simple when following the detailed instructions in this manual. A low parts count and professional engineering ensure quick and easy assembly. All parts are CAD-drawn, laser-cut, and jig assembled, which means that everything fits the way it should!

We urge you to read this assembly manual completely before assembly. Familiarize yourself with the parts and the assembly sequences. The successful assembly and flying of this airplane is your responsibility. If you deviate from these instructions, you may wind-up with problems later on.

Good luck with the RASCAL. Let's get started!

ADDITIONAL ITEMS YOU WILL NEED TO PURCHASE

In addition to this kit, you will need the following items to complete your RASCAL 80 EG ARF and make it flyable.

RADIO SYSTEM

The RASCAL 80 EG requires a standard 4-channel radio system and four to five standard size servos. In addition, you'll need two 12-18" long Servo Extension wires (actual length needed will depend on how long the wires are coming off your servos – plan accordingly), and one Y-Harness for connection of the two aileron servos to the receiver.

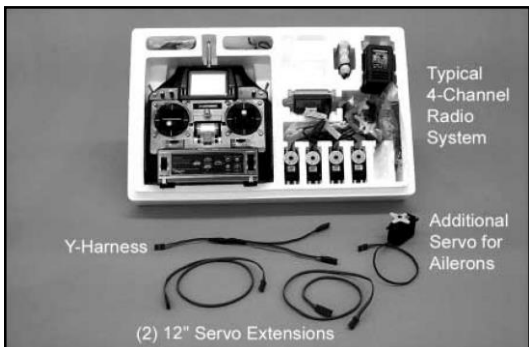

POWER SYSTEM - GLOW OR ELECTRIC?

The biggest decision you will have to make is whether to power your RASCAL 80 with a glow engine (2-stroke or 4-stroke) or an electric motor. We have flown the RASCAL 80 on a variety of both types of power systems, and we make the following recommendations based on our successful on-field experience.

GLOW POWER RECOMMENDATIONS

ENGINE

We recommend the following engine sizes for the RASCAL 80.

- 2-STROKE - .46 to .55 cu. in.**
- 4-STROKE - .53 to .65 cu. in.**

SIG carries O.S. Engines for the Rascal 80, and we suggest the following engines.

- 2-Stroke - O.S. .46AXII (SIG Part# OSMG0548)
- 2-Stroke - O.S. .55AX (SIG Part# OSMG0557)
- 4-Stroke - FS56-a (SIG Part# OSMG0956)
- 4-Stroke - FS-62V (SIG Part# OSMG0898)

Whichever brand of engine you choose, take the time to carefully break it in according to the manufacturer's instructions. A good running, reliable engine is a minimum requirement for the enjoyment of this or any R/C model aircraft.

PROPELLER FOR GLOW

Refer to the engine manufacturer's instructions for recommendations on proper propeller size for their engine. In our experience, most 2-stroke .46-.55 glow engines will fly the RASCAL 80 very nicely with an 11x6 or 12x6 prop.

ELECTRIC POWER RECOMMENDATIONS

600-1100 watt BRUSHLESS OUTRUNNER MOTOR

There are many fine 600 to 1100 watt electric outrunner motors on the market that will fly the RASCAL 80. We use the Himax HC5018-530 (SIG Part# MXACC5018530) Brushless Outrunner Motor.

Specs:

- Case diameter: 50mm
- Case length: 53mm
- Shaft diameter: 6.0mm
- Weight: 275g (9.7 oz.)
- Max Watts: 900
- KV = 530
- Rm = .033 Lo = 1.8

60-80 amp ESC (Electronic Speed Control)

We use the Castle Creations Phoenix EDGE 75 ESC or the Castle Creations Phoenix EDGE Lite 75 ESC (SIG Part# CSE010011200). We typically see amp draw of 30 to 50 amps, depending on which 4 to 5 cell LiPo is being used, and the propeller size.

NOTE: The Castle Creations ESCs that we used, as well as the many of the other ESCs on the market, have a BEC (Battery Eliminator Circuit) built in. BEC allows you to use the same battery pack to Power both your motor and your radio system, eliminating the normal radio battery pack. As the dual purpose battery runs down in flight, the BEC circuit in the ESC will shut down the motor and leave enough power to operate the radio while you land the model. Check the manual of your particular ESC to learn how to use the ESC.

4 or 5 cell 5000mah LITHIUM-POLYMER BATTERY PACK

With the Himax HC5018-530 motor we use 4 cell (4S1P) 5000mah or 5 cell (5S1P) 5000mah LiPo packs. A 4 cell pack (14.8 volts) provides flight performance similar to a .46 glow engine. A 5 cell pack (18.5

volts) provides flight performance similar to a .55 glow engine. We find that 5000mAh LiPo packs provide between 10 to 15 minutes of flight time, depending on propeller selection and other factors (quality of pack, throttle management, outside temperature, etc.). CAUTION: You must match your propeller size to the cell count of your LiPo pack, to avoid drawing too many amps and damaging your ESC or motor.

❑ PROPELLER FOR ELECTRIC

With the Himax HC5018-530 motor and a 4-cell (4S1P) 14.8v LiPo pack, we recommend an APC 12x8E (SIG Part# APC12080E) or 13x6.5E (SIG Part# APC13065E) propeller. This size delivered good performance, very reminiscent of a 2-stroke .46 glow engine. For a starting prop we recommend the APC 12x8E. Other brand propellers of same size and similar design can also be used. NOTE: Your results may vary due to other factors – the specs of your individual motor and battery pack, etc. You may need to experiment with different props to find your best combination.

With the Himax HC5018-530 motor and a 5-cell (5S1P) 18.5v LiPo pack, we recommend an APC 14x8.5E propeller. This size delivered good performance, very reminiscent of a 2-stroke .55 glow engine. Other brand propellers of same size and similar design can also be used.

SIG Rascal 80 Electric Combo (SIG Part# SICRC880EGARFC)

- Himax 5018-530 motor
(SIG Part# MXACC5018530)
- Castle Creations Phoenix Edge Lite 75 Amp ESC
(SIG Part# CSE010011200)
- APC 12x8E propeller
(SIG Part# APC12080E)

❑ BATTERY CHARGER

FOR SAFETY AS WELL AS PERFORMANCE, CHARGE LIPO BATTERIES ONLY WITH A LIPO BATTERY CHARGER!

In addition to providing the critical charging profile needed to safely charge LiPo batteries, a LiPo battery charger also includes the capability of "balancing" the available voltage in the cells, ensuring that the battery pack is at peak capacity at the end of the charge cycle. This translates to better flight times and a longer life from the battery pack.

❑ REQUIRED TOOLS

For proper assembly, we suggest you have the following tools and materials available:

- A selection of glues - SIG Thin, Medium, & Thick CA Glue
- CA Accelerator
- CA De-bonder
- SIG Kwik-Set 5-Minute Epoxy
- Screwdriver Assortment
- Pliers - Needle Nose & Flat Nose
- Diagonal Wire Cutters
- Small Allen Wrench Assortment
- Pin Vise for Small Dia. Drill Bits
- Hobby Knife with Sharp #11 Blades
- Small Power Drill with Selection of Bits
- Dremel® Tool with Selection of Sanding & Grinding Bits
- Scissors
- Sandpaper
- Covering Iron & Trim Seal Tool
- Masking Tape
- Paper Towels
- Alcohol and/or Acetone for Epoxy Clean-up

❑ COMPLETE KIT PARTS LIST

The following is a complete list of all parts contained in this kit. Before beginning assembly, we suggest that you take the time to inventory the parts in your kit. Use the check-off boxes (q) provided

in front of each part description. Please also note that the bolts and nuts required to mount your engine to the motor mounts are not included and must be purchased separately.

- (1) Fuselage with Removable Battery Hatch
- (1) Right Wing Panel & Aileron, hinges not glued
- (1) Left Wing Panel & Aileron, hinges not glued
- (1) Horizontal Stabilizer & Elevator, hinges not glued
- (1) Vertical Fin & Rudder, hinges not glued
- (1) Cowling with (4) M3 x 10mm PWA Mounting Screws
- (1) Right & Left Molded Clear Plastic Side Windows

Main Landing Gear

- (1) Formed Aluminum Main Landing Gear
- (2) 3" dia. Main Wheels
- (1) Right Fiberglass Wheel Pant
- (1) Left Fiberglass Wheel Pant
- (2) Axles with 8mm Mounting Bolt and 8mm Lock nuts
- (4) M3 x 10mm Mounting Bolts, for wheel pant mounting
- (3) M4 x 20mm Mounting Bolts, for landing gear mounting
- (3) M4 Flat Metal Washers, for landing gear mounting
- (3) M4 Split-Ring Lock Washers, for landing gear mounting

Tailwheel Assembly

- (1) Tail Wheel Assembly with Steering Arm & Tailwheel
- (1) 3-Arm Rudder Steering Horn, Metal
- (2) M3.5 x 18mm Wood Screws, for Rudder Steering Horn
- (2) M3x 16mm Mounting Bolts, for Tailwheel Assembly
- (2) M3 Split-ring washers for Tailwheel Mounting Bolts
- (2) Coil Steering Springs

Spinner Assembly

- (1) 2-1/4" dia. White Spinner Cone
- (1) 2-1/4" dia. White Spinner Back-plate
- (2) T3 x 14mm Phillips-Head Mounting Screws

Control Horns, Etc.

- (5) Nylon Fiberglass Horns; for ail(2); elev(1); rud(2)
- (1) Nylon Control Horn Backing Plate
- (6) M2 x 15 mm Wood Screws
- (6) M2 x 14 mm Machine Screws
- (6) M2 Nuts
- (2) 1/4-20 x 1-3/4" Nylon Wing Bolts

Pushrods

- (2) 2mm dia. Steel Pushrod, elev.
- (1) 1.22mm dia. x 490mm Steel Pushrod and guide tube, for throttle
- (5) Metal R/C Links, for ail(2), elev(1), rud(4)
- (1) Pushrod Connector for Throttle
- (3) Nylon Snap Keepers
- (2) Pull-Pull Rudder Parts Kit
- (2) 2mm dia. 170mm Aileron Pushrods, threads one end and M2 Nut

Miscellaneous

- (1) Aluminum Wing Joiner tube
- (1) 8mm Hardwood Rear Wing Locating Pin (pre-installed)
- (1) Decal Sheet

Fuel Tank for Glow Engine

- (1) Fuel Tank Body - 295cc (10 oz.)
- (1) Rubber Stopper
- (1) M3 x 34mm Bolt
- (1) Metal Clunk Pick-Up
- (3) Plastic Tube - 4mm od x 60mm
- (2) Zip-Ties
- (1) 5/16" x 3/4" x 3-3/16" Balsa Fuel Tank Retainer

Engine Mounts for Glow Engine

- (1) Right Nylon Engine Mount
- (1) Left Nylon Engine Mount
- (8) M4 x 25mm Mounting Bolts
- (8) M4 Flat Metal Washers
- (4) M4 Blind Nuts
- (4) M4 Nylon Insert Locking Nuts

Electric Power Accessories

- (1) Adjustable Wood Motor Box
- (1) Balsa Tri Stock Stick
- (2) Hook n Loop Straps

NOTE: "PWA Screws" are metal screws with a Phillips/washer style head.

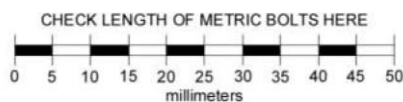

COVERING MATERIAL

Your RASCAL ARF is covered with ORACOVER®, a premium quality covering made in Germany, and sold in the U.S. by Hanger-9 as Ultracote®.

Colors Used On Your Airplane

ORACOVER® #10 White (Ultracote® #HANU870) and
ORACOVER® #29 Transparent Red (Ultracote® #HANU950) or
ORACOVER® #59 Transparent Blue (Ultracote® #HANU954)

If sometime in the future you need replacement covering or matching paint for repairs, they are available from your local hobby dealer or online from Hanger-9.

How to Tighten Loose Covering

After you open your RASCAL 80 and take all the covered parts out of their plastic bags, the covering may begin to wrinkle. This is not unusual and is no cause for alarm.

Your airplane was built and covered in a part of the world which has relatively high humidity and therefore, the wood was likely carrying a fair amount of moisture. When exposed to drier air, the wood typically loses this moisture, dimensionally "shrinking" in the process. In turn, this may cause some wrinkles. However, wrinkles are easy to remove by just using a hobby type heat iron. Caution: Trying to remove the wrinkles by hastily going over them with a heat gun can lead to more problems. You should take your time to carefully go over the entire model with a covering iron, as we will describe.

We suggest using a model airplane covering iron for this process. Cover the iron's shoe with a thin cotton cloth, such as an old T-shirt, to prevent scratching the covering as you work.

After covering your iron, the next step is to set the iron to the correct temperature. This is critical for achieving a good result! The iron

should be set to about **220°F - 250°F (104°C - 121°C)** as measured on the bottom of the iron using a thermometer.

If you do not have a thermometer, you can find the correct temperature by trial and error. Set your iron to a medium setting. Glide the iron over some of the covering that is over solid wood, such as the sheeted wing center section. Observe the covering to see if any bubbles appear. If bubbles appear, the covering is getting too hot! Turn down the temperature of the iron and repeat the test.

If no bubbles appear, turn up the heat slightly and repeat the test. Keep adjusting until you "zero in" on the correct temperature. Find the temperature that will get the covering to stick down without forming bubbles or causing the seams to pull away.

Once your iron is set to the correct temperature, go over the entire framework of the airplane, making sure that the covering is securely bonded to the structure everywhere the covering comes in contact with the wood underneath. This takes some time, but is worth the effort.

After you have all the covering secured onto the solid areas, turn the temperature of the iron up to approximately **300°F - 320°F (149°C - 160°C)**. This is the correct temperature for shrinking the covering material.

Use the iron to tighten up any wrinkles in the "open" areas of the model (no wood underneath the covering). Glide the iron over the wrinkle for a few seconds, then remove. Repeat until the covering is tight with no wrinkles.



If wrinkles keep coming back on the tail surfaces, you may need to "ventilate" the areas between the ribs. Otherwise the air that is sealed in those relatively small areas will expand when the heat is applied and actually cause the covering to stretch instead of shrink. Use a pin to poke a tiny hole in the covering between each rib, on the bottom of the part. That will let the expanding air escape and the covering to shrink properly.

Caution When Using Heat Guns:

You can also use a hobby-type heat gun to shrink the covering, but you must be careful around seams or color joints. Getting too much heat on the seams may cause them to "creep" or come loose. You must also be careful when using a heat gun when working around the windshield and side windows – heat will distort the clear plastic material.

Recommended Temperatures:

To adhere the covering - 220°F - 250°F (104°C - 121°C)

To shrink the covering - 300°F - 320°F (149°C - 160°C) NOTE: In this manual, any references to right or left, refer to your right or left as if you were seated in the cockpit of the airplane.

WING ASSEMBLY

The wings are designed as a 2-piece system, with separate right and left wing panels joined by an aluminum tube wing joiner and a hardwood locating pin at the rear. Due to the high strength of the wing joiner tube, the wing panels do not need to be permanently glued together. Gluing them permanently together is optional – it's your call. The obvious benefit to leaving the wing panels separate is the fact that they can be easily transported or stored, requiring a minimum of space.

To help protect your wings during the following steps we recommend that you cover your work surface with a soft cloth or piece of foam.

INSTALLING THE AILERON SERVOS

For the following steps you will need:

- (1) Right Wing Panel
- (1) Left Wing Panel
- (1) Aluminum Tube Wing Joiner
- (2) Servos with Mounting Screws (not furnished)
- (2) 12"-18" Servo Extension Wires (not furnished)
- (1) Servo Y- Harness (not furnished)

□ 1) Mount the aileron servos in the bottom of each wing panel.

- a) The servo bays are pre-cut for you but you'll want to double check the covering around the cutout to make sure it is sealed down tight.
- b) Install the rubber grommets and brass eyelets (supplied with your radio system) into each aileron servo.
- c) Install the control arms on the two aileron servos. The arms should be at 90 degrees to the servo when the aileron control stick on the transmitter is in neutral and the transmitter trims are in neutral as well.
- d) Before installing the aileron servos in the wing panels you must attach a servo extension cord to the aileron servo wire. The typical combined length required is approximately 24". A 12-18" extension wire will usually provide sufficient length. Plug the servo plug into the extension cord and tape the plugs together for added security.

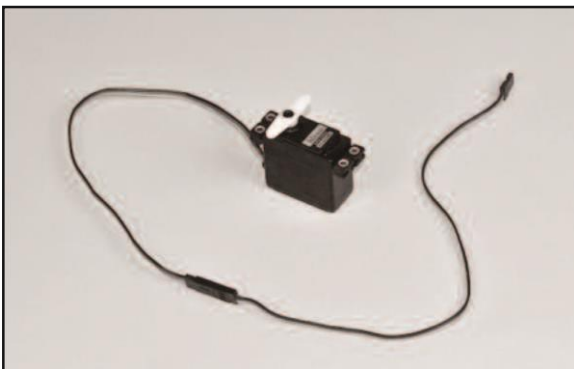

e) A servo wire pull string has been pre-installed in the wing at the factory. Attach the string to the end of your servo extension wire, and carefully pull the servo extension wire through the wing. Once you've got the plug to the end rib, direct it through the round hole in the bottom surface of the wing panel. By that time, the servo itself should be next to the servo mount cutout and ready for mounting.

f) Fit the servo into the servo mount in the wing panel, (note that the servo is positioned so that the servo arm is at the forward end toward the wing leading edge). Take up any slack in the servo wire as you insert the servo in the mount. Use a pin vise and a small drill bit to drill small pilot holes in the servo mount for the servo mounting screws. Use the screws supplied with your radio system to mount the servo in place on the servo mount. Repeat this procedure to mount the servo in the opposite wing panel.

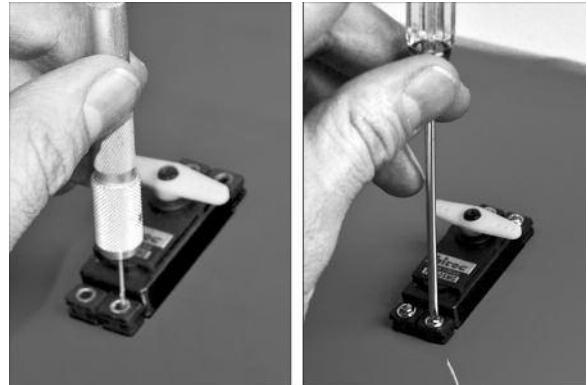

HINGING THE AILERONS

□ 2) Note that the CA Hinges are installed, but not yet glued, in the ailerons and wing panels. The installation process for the hinges is the same for all of the control surfaces on this model.

a) If you removed the ailerons and hinges from the wing panels when you tightened the covering material, reinstall them now. First insert the four CA Hinges into the slots in the aileron. Put two pins in the center of each hinge, up against the leading edge of the aileron, to keep the hinges centered during the next step.

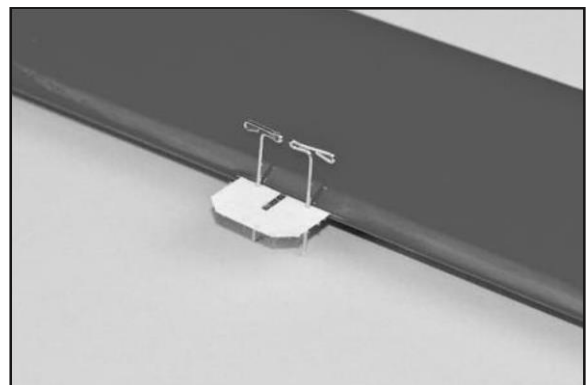

b) Now carefully insert the exposed portion of the four hinges into the trailing edge of the wing. You will find it easiest to slide the hinges into the slots at angle, one hinge at a time, instead of trying to push in straight onto all the hinges at once.

c) Adjust the aileron so that the tip of the aileron is flush with the wing tip. The ailerons should be tight against the pins in the hinges to minimize the gap between the wing and the aileron. The aileron is now in the proper position for permanently gluing them in place with thin CA glue.

d) Flex the aileron down and hold it in this position. Remove the pins from one hinge and then carefully apply 3-4 drops of thin CA glue directly onto the hinge in the gap. You will notice that the glue is quickly wicked into the slot as it penetrates both the wood and the hinge. We suggest using a fine tipped applicator on the glue bottle to better control the flow of glue.



- e) Turn the part over and glue the other side of the hinge. Continue this process until you have glued both sides of all the hinges! Keep a rag handy to wipe off any excess thin CA glue. (If you get some glue smears on the plastic covering, don't worry about them right now. Once all the hinging is done, you can clean the smears off the covering with CA De-bonder.
- f) Let the glue dry 10-15 minutes before flexing the hinges. At first you might notice a little stiffness in the joint. This will go away after the hinges have been flexed back and forth a few times.

INSTALL AILERON CONTROL HORNS & PUSHRODS

From the kit contents locate:

- (2) Nylon Control Horns
- (6) M2 x 15 mm PWA Screws
- (2) Short Pushrod Wires with M2 Hex Nut
- (2) Metal R/C Clevis
- (2) Nylon Pushrod Keepers
- (2) Small pieces of Fuel Tubing

- 3) Look closely and you will see three holes pre-drilled in the bottom of the ailerons for mounting the nylon control horns. Screw the control horn in position on the bottom of the aileron using three M2 x 15mm wood screws. It's a good idea to remove the screws after installing them, adding a drop of thin CA to each threaded hole. This will harden the wood and give the screws a better bite into the wood. When the thin CA had dried, reinstall the three aileron screws.



- 4) Next assemble and install the aileron pushrods.

- a) Slide a short piece of Fuel Tubing onto the small end of the Metal R/C Clevis. Screw the Hex Nut on the Aileron Pushrod Wire all the way up to the end of the threads. Then screw the metal clevis halfway onto the threaded end of the Aileron Pushrod Wire.

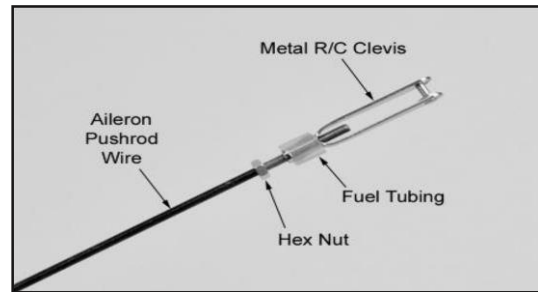

- b) Clip the metal clevis into the last hole in the nylon control horn. Lay the other end of the pushrod wire over the outer hole in the servo arm. Use a felt tip pen to mark the wire where it crosses the hole. Use a pair of pliers to put a sharp 90-degree bend in the wire at the mark.

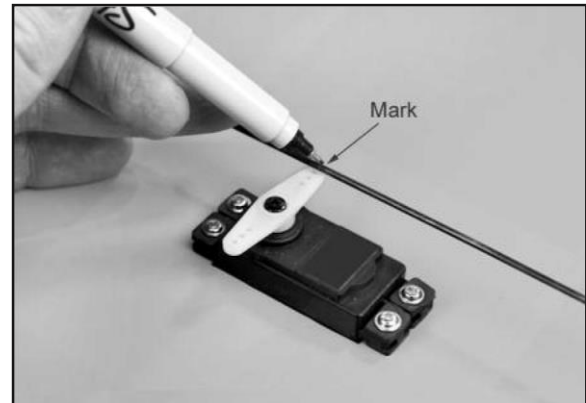

- c) Insert the bent end of the pushrod into the servo arm, from the top. Note: You will most likely need to use a 1/16" dia. drill to open the hole in the servo arm to accept the pushrod wire.
- d) Mark and cut off the excess end of the pushrod wire, leaving 1/8" of wire protruding below the bottom of the servo arm.
- e) Clip a Nylon Pushrod Keeper in place on the servo end of the pushrod wire. Snap the free end of the keeper up and over the protruding end of the pushrod wire, underneath the servo arm.

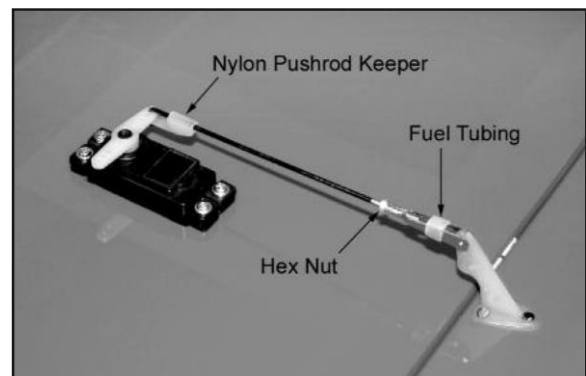

- f) Check that the aileron servo is in neutral position and adjust the metal clevis as needed to get the aileron in neutral position.
- g) Once the ailerons are properly adjusted, insure that the metal clevis can't open up and come loose from the control horn by sliding the piece of Fuel Tubing over the arms of the clevis. Also tighten the M2 Hex Nut up against the back of the clevis.

FUSELAGE ASSEMBLY

INSTALL THE MAIN LANDING GEAR

Locate the following parts from the kit contents:

- (1) Fuselage
- (1) Aluminum Main Landing Gear
- (3) M4 x 20 mm Socket-Head Bolts
- (3) M4 Split-Ring Lock Washers
- (2) 3" dia. Main Wheels
- (2) 4 mm dia. Axles with threaded bolt Head
- (2) 8 mm Hex Nuts; for axles
- (4) 4 mm ID Wheel Collars; for axles
- (1) Right Fiberglass Wheel Pant
- (1) Left Fiberglass Wheel Pant
- (4) M3 x 12 mm Socket-Head Bolts

NOTE: We suggest you use a thread locking liquid (like Loctite®) on all bolts and nuts used in the assembly of the landing gear.

- 5) Install a Threaded Axle into the large hole of the landing gear leg, With the plain end of the axle shaft pointing to the outside. Secure the axle with the 8mm Hex Nut. When tightening the nut, keep the flats of the hex nut on the axle side of the gear leg parallel to the front edge of the leg - see photo. This allows the hex nut to fit inside the narrow notch in the wheel pants when they are added later.

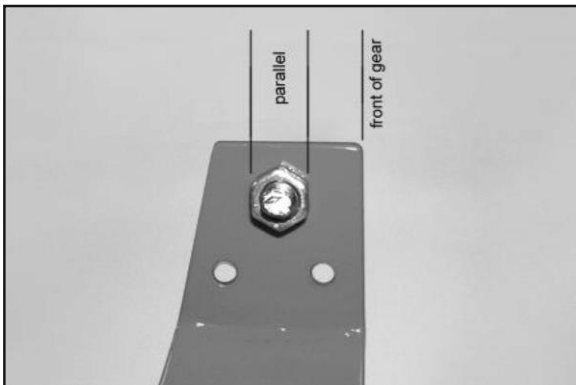

- 6) Slide a 4mm Wheel Collar onto the axle shaft against the head of the Axle. Tighten the wheel collar set screw securely.

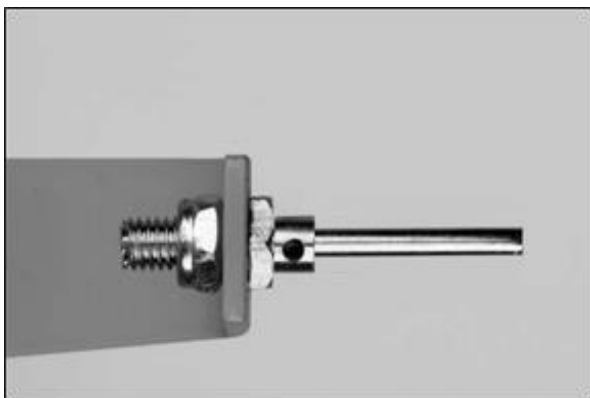

- 7) Slide the wheel on the axle and test to make sure it spins freely on the axle. If it does not turn freely, drill out the plastic hub of the wheel with an 11/64" or #17 drill bit.

- 8) Slide a second wheel collar onto the axle and up to the wheel. Leave a small gap between it and the wheel, so the wheel will turn freely, and then tighten the wheel collar set screw.



- 9) Check the orientation of the landing gear to make sure you know which way is forward. The two outer holes for mounting the gear to the fuselage go to the front. Then test fit the wheel pants over the wheels and line up the predrilled mounting holes. Secure the wheel pants in place with two M3 x 12mm socket head bolts for each pant. (You may need to clean a little paint out of the blind nuts inside the wheel pants in order to start the mounting bolts. A #11 hobby knife works well for this.)

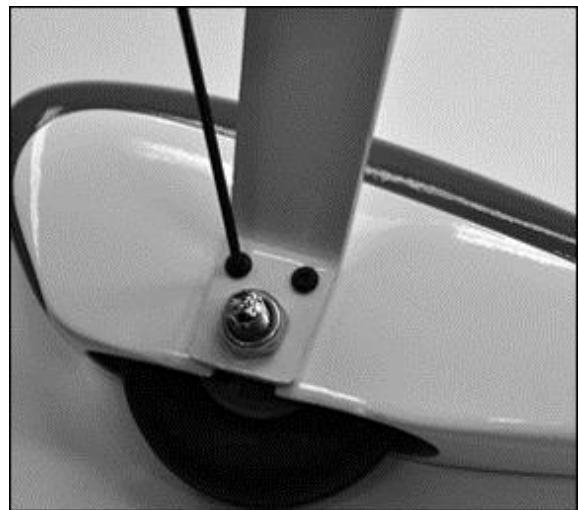

- 10) Attach the landing gear to the bottom of the fuselage using three M4 x 20mm Socket-Head Bolts and three M4 Split-Ring Lock Washers.

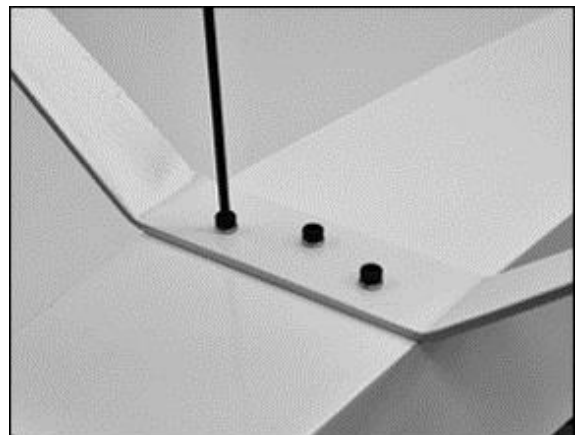

TAIL SURFACE AND TAILWHEEL INSTALLATION

For the following steps you will need:

- (1) Fuselage
- (1) Wing
- (1) Horizontal Stabilizer & Elevator set
- (1) Vertical Fin & Rudder Set M6.5 Nylon Wing Bolts

- (1) Tailwheel Assembly
- (2) Coiled Steering Springs
- (1) Steering Arm
- (2) M3 x 12 mm Screws
- (2) Split Lock Washers
- (3) Nylon Control Horns
- (1) Nylon Control Horn Retaining Plates
- (6) M2 x 14 mm Screws
- (6) M2 Nuts

□ 11) Remove the elevator and hinges from the horizontal stabilizer, and set them aside for now. Test fit the stabilizer on the fuselage. Notice that the covering has been removed from both the fuselage and horizontal stabilizer where they will mate together. Eyeball the location of the horizontal stabilizer and pin it temporarily in place.

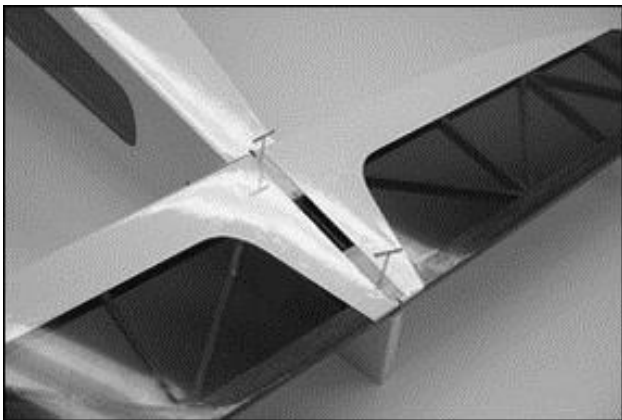

□ 12) Bolt the wing in place on the fuselage with the Nylon Wing Bolts provided. Carefully check the alignment of the stabilizer to the wing.

a) First view the model from directly in front. Check to see if the stabilizer is level with the wing. You should find it to be very close. If necessary use a sanding block to fine tune the stabilizer platform to level the stabilizer to the wing.

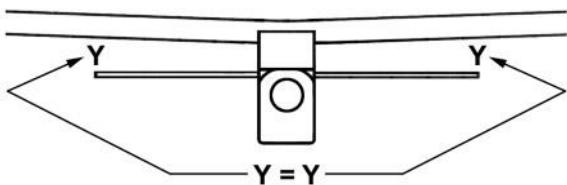

b) Next use a tape measure to measure the distance from each stab tip to the back edge of the wing – the distance should be equal on both sides. Adjust if necessary.

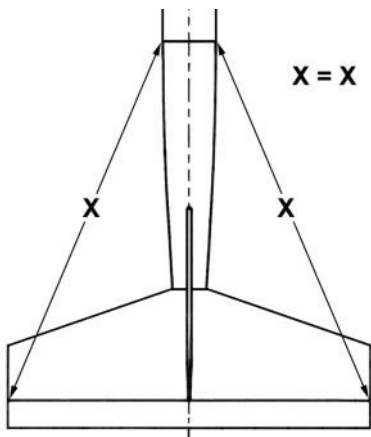

c) Use a fine line felt tip pen to mark some guide lines on the stabilizer that will make it easy for you to realign the stab after the glue is applied in the next step. You can now remove the pins and take the stabilizer off the fuselage for gluing.

□ 13) The horizontal stabilizer can now be glued permanently onto the rear of the fuselage. We suggest using slow curing epoxy glue for this job to allow time to position the stab accurately and make any final adjustments that might be needed. Apply the glue to both sides and reset the stab in place. Use pins to hold it in place. Re-check the alignment. Wipe away any excess epoxy with rubbing alcohol and a soft paper towel. Allow the glue to cure completely.

□ 14) Pull the Fin and Rudder apart set the rudder and hinges aside for now. Test fit the fin in place on top of the stabilizer. Check to see that the fin sits flush and perpendicular to the stabilizer. When satisfied with the fit, glue the fin in place using slow curing epoxy glue. Apply a coat of epoxy to the bottom of the fin and to the exposed wood on the stab. With the fin in place, sight the model from the front to make sure the fin is absolutely 90 degrees upright to the stab. If needed, use masking tape to hold it in alignment until the epoxy cures. Wipe off any excess glue with rubbing alcohol and a soft paper towel. Let the epoxy completely cure.

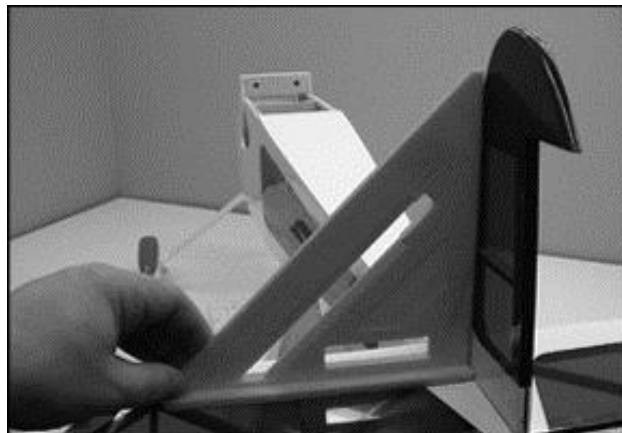

□ 15) Hinge the elevator to the stabilizer, using the same techniques you did for the ailerons back in Step 2 of this manual. Let the hinges dry before flexing them.

□ 16) Now it's time to install the rudder.

a) Carefully insert the front side of the three CA Hinges into the hinge slots in the back of the fin, using the same techniques you did for the ailerons back in Step 2 of this manual. When you've got the rudder all the way on, double check that the top of the rudder lines up with the top of the fin.

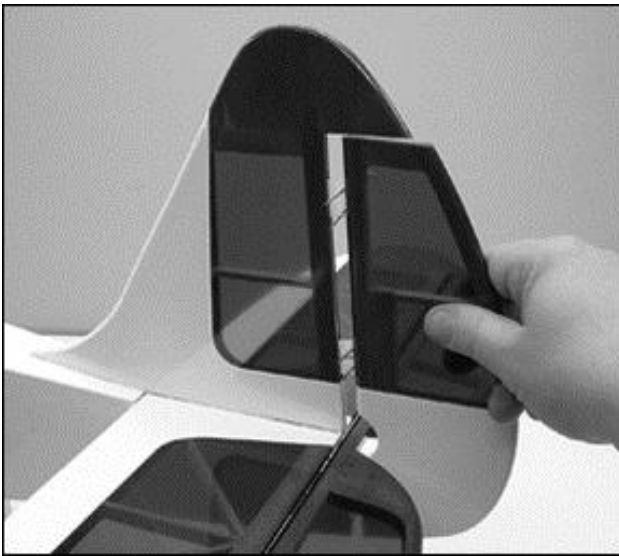

□ 19) Next we will mount the Tailwheel Assembly in place on the lower rear end of the fuselage.

a) Begin by placing the three armed rudder steering horn on the bottom of the rudder. The front edge of the steering horn should be 1 / 4" back from the beveled edge of the rudder. Mark the location of the two steering arm holes on the bottom edge of the rudder.

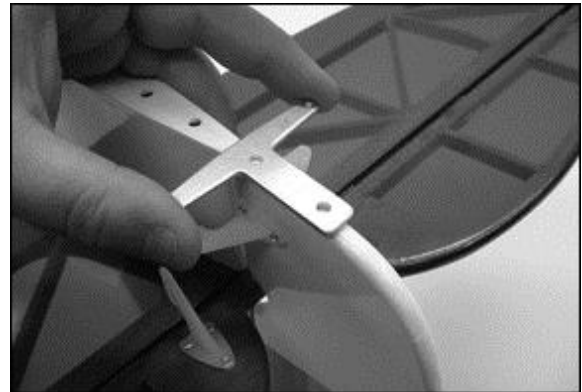

b) Finish the rudder installation by gluing the CA Hinges in place with thin CA.

□ 17) Look closely and you will find three holes pre-drilled near the bottom of the rudder for mounting the nylon control horns. Run a 5/64" Drill through the three holes. Install the Pull-Pull control horns on the both sides of the rudder, using three M2 x 14mm Screws and three M2 Nuts, making sure to add a drop of thread locker to each screw before tightening the nut.

b) Using a 5/64" drill bit, drill a hole at each location you marked, Making sure to keep the drill bit straight to the rudder - you do not want the drill bit to come out the side of the rudder.

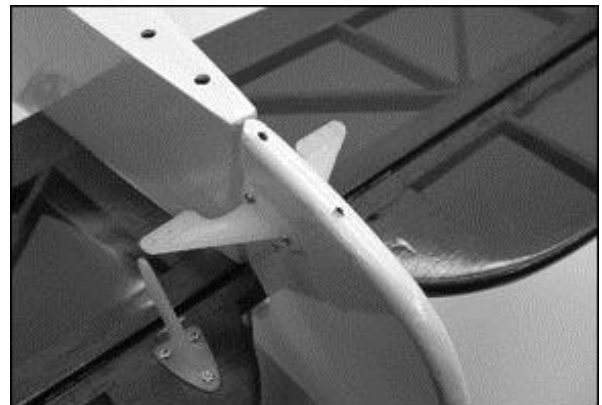

c) Thread one of the M3.5 PWA screws into each of the holes, then remove the screw. Add a drop of thin CA to each hole to harden the threads. When the CA has dried, install the three armed steering horn to the bottom of the rudder with the two M3.5 screws.

□ 18) There are three holes pre-drilled in the RIGHT side elevator for mounting a nylon control horn. Screw the control horn in position on the bottom of the elevator, with the retaining plate on the top, using three M2 x 14mm Screws and three M2 nuts, making sure to add a drop of thread locker to each screw before tightening the nut.

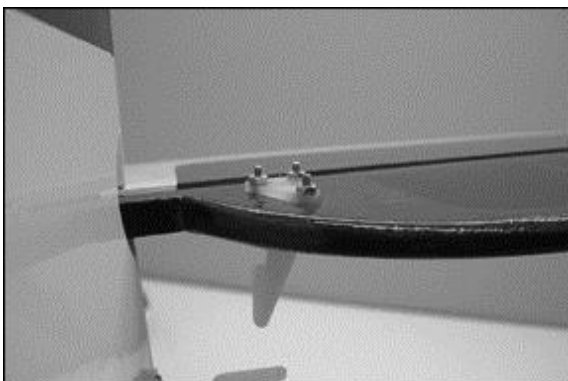
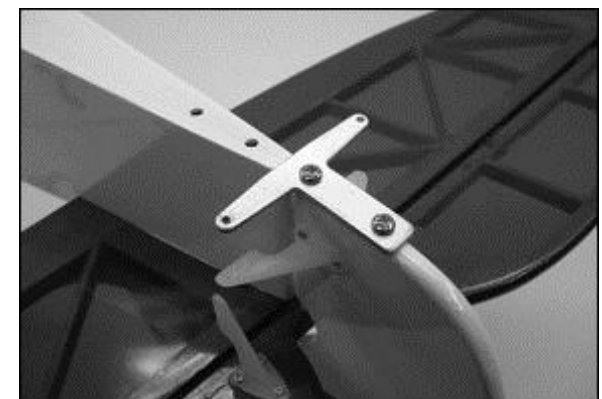

d) Attach the pre-assembled tailwheel bracket to the fuselage using two M3x18mm machine screws and split-ring lock washers. Add a drop of thread locker to each of the M3x16mm machine screws before tightening them.

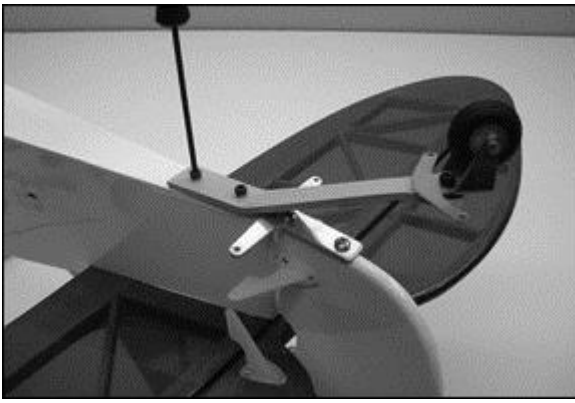

- e) Attach the steering springs to the three armed steering horn and the tailwheel horn.

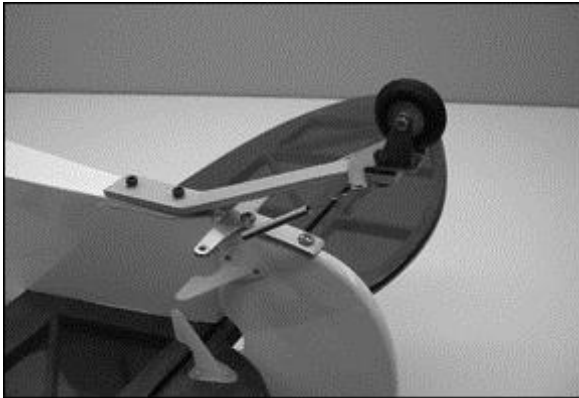

ELEVATOR & RUDDER CONTROLS

For this section you will need:

- (1) Fuselage Assembly
 - (1) Elevator Pushrod with M2 Hex Nut
 - (1) Metal RC Clevis
 - (1) Small pieces of Fuel Tubing
 - (1) Pull-Pull Rudder Kit
 - (1) Pushrod Snap Keepers
 - (1) Radio Receiver (not furnished)
 - (1) 2" Double Servo Arm (not furnished)
 - (2) Servos with Mounting Screws (not furnished)
- 20) Install the elevator servo inside the fuselage in the built-in plywood radio mounting tray. Note that the elevator servo goes on the left side with the output shaft to the front of the fuselage. (The servo openings in the front of the tray are for the throttle servo in a glow engine installation.) Be sure to drill pilot holes through the plywood tray for the mounting servo mounting screws.
- 21) Mount your receiver in a place of your choosing. If using a glow engine it is recommended that you wrap the receiver in foam rubber (not furnished) to protect it from vibrations.
- 22) If you are using a receiver battery pack (some electric powered setups don't), mount your on/off switch in the fuselage side. Note that there are pre-cut holes in the fuselage sides, Underneath the covering material, for either a standard size switch or a super switch with built-in charging plug. Cut away the covering over the hole that fits your switch and mount using the screws supplied with your switch.
- 23) Assemble and install the elevator pushrod.
- a) First slide a small piece of Fuel Tubing onto the small end of the Metal R/C Clevis. Next screw the Hex Nut that is on the Pushrod Wire all the way up to the end of the threads. Then screw the

metal clevis halfway onto the threads.

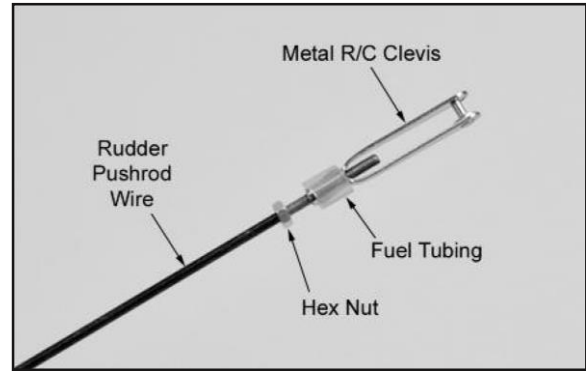

- b) Locate the pre-cut upper pushrod exit hole for the elevator on the right side of the fuselage. Slide the end of the pushrod wire (without the clevis) into the exit hole and inside the pushrod sleeve built into the fuselage. Slide it in until you can clip the clevis into the middle hole of the control horn. Lock the elevator in neutral position with a piece of masking tape.
- c) Inside the fuselage, hold the pushrod wire over the elevator servo output arm and mark the wire where it crosses over the outer hole in the arm. Make sure the servo is in neutral position.



- d) Unclip the clevis from the elevator control horn so that you can now pull as much of the wire pushrod forward into the radio compartment as possible, to make it easier to finish the servo end of the pushrod. Mark and cut the servo end of the pushrod wire 1/4" past the mark you made in the last step. Then use a pliers to put a 90-degree bend in the wire at the mark.



- e) With the pushrod still disconnected from the rudder, remove the servo arm from the servo. Install the servo arm and a nylon pushrod snap keeper on the end of the pushrod, as shown. Then re-install the servo arm on the servo.



- a) Locate the pull-pull hardware bag, and lay out the parts.
- b) Thread an M3 nut and a metal clevis onto the brass rigging coupler. Do this step four times.



- f) Make sure that the elevator servo is in neutral position and then adjust the metal clevis at the tail end as needed to get the elevator in perfect neutral position.
- g) After the elevator is properly adjusted, insure that the metal clevis can't open up and come loose from the control horn by sliding the small piece of fuel tubing over the arms of the clevis. Also tighten the M2 Hex Nut up against the back of the clevis.

- c) Slide one of the crimp tubes onto the nylon coated braided steel wire, then thread the wire through the hole in the brass rigging coupler and back through the crimp tube.

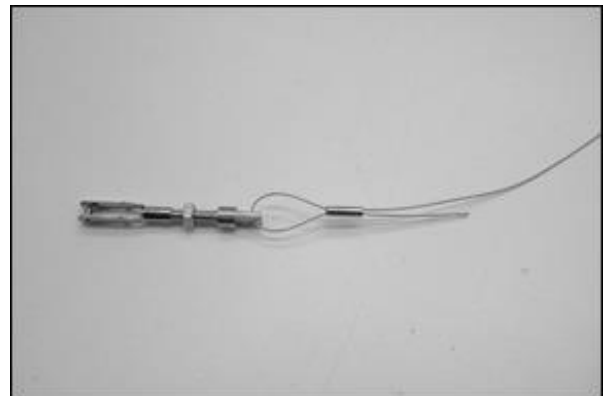
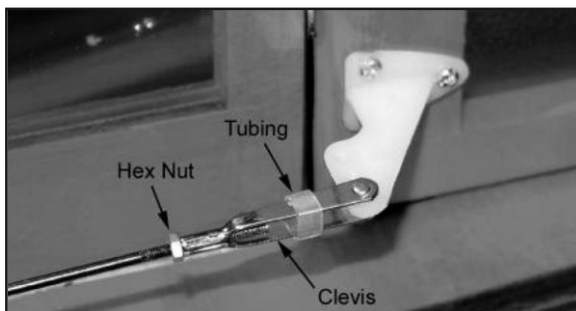

- 24) Install the rudder servo inside the fuselage in the built-in plywood radio mounting tray. Note that the rudder servo goes in the center servo opening, with the output shaft to the rear of the fuselage. Be sure to drill pilot holes through the plywood tray for the mounting servo mounting screws.

- d) Loop the wire back through the crimp tube and pull the loops tight – there's not much extra wire, so being conservative here will give you a little extra on the other end of the wire.

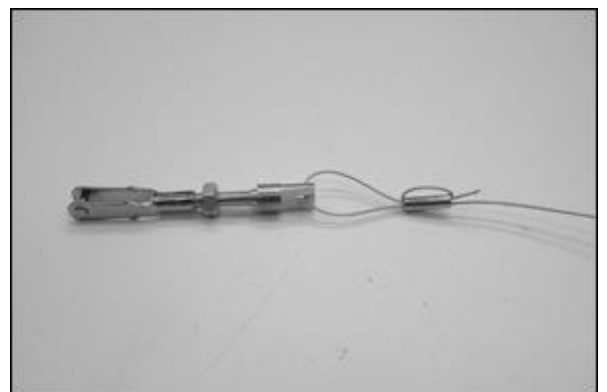

ELECTRIC POWER SYSTEM

Skip this section if you're using a glow engine power setup

For this section you will need the Fuselage and:

- (1) Fiberglass Cowling
- (4) M3 x 10mm Screws
- (1) Plywood Electric Motor Mount
- (1) Plywood Battery Box
- (1) Balsa Triangle Stock
- (4) M4 x 20mm Socket-Head Bolts
- (4) M4 Flat Metal Washers
- (4) M4 x 16mm Socket-Head Bolts
- (4) M4 Split-Ring Lock Washers
- (4) M4 Blind Nuts
- (1) Hook-&-Loop (Velcro®) Straps
- (1) Electric Motor, ESC, Prop, LiPo Battery (not furnished)

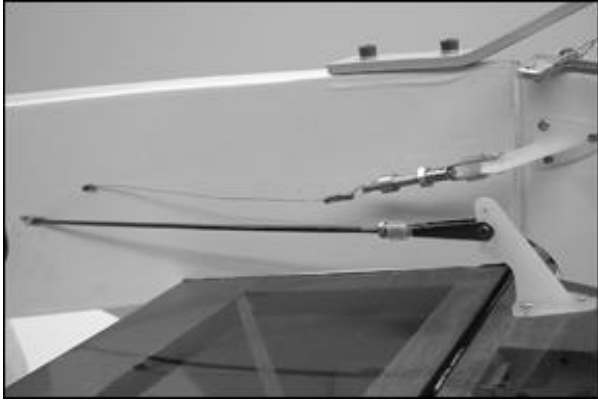

- f) Repeat steps c) through e) again to make the other pull-pull wire, and tape the rudder in a neutral position.
- g) Attach a 2" double servo arm (not furnished) to the rudder servo. With both of the metal clevises attached to the rudder control horns, pull the wires through the fuselage - (an extendable magnetic parts grabber is helpful for this step). Attach the remaining two metal clevises to the rudder double servo arm.
- h) After crossing the wires once, slide a crimp tube onto one of the wires, thread the wire through the brass rigging coupler and pull the wire snug. Using a needle-nosed pliers, pinch the wire against the rigging coupler to mark the wire.
- i) Remove the metal clevis from the rudder control horn and double servo arm - this will allow you to pull the wire and rigging coupler forward enough to work with it inside the fuselage.
- j) While keeping the wire located at the marked position, loop the wire through the crimp tube and secure it by crimping the tube.
- k) Repeat steps h) through j) for the second pull-pull wire. At this point, all four metal clevises can be connected - two to the rudder control horns and two to the servo arm. The wires might be slightly loose, and can be tightened by turning the brass rigging couplers into the metal clevises. When the wires are tight (snug, but not like guitar strings), tighten the M3 nuts against the metal clevises on all four rigging couplers.

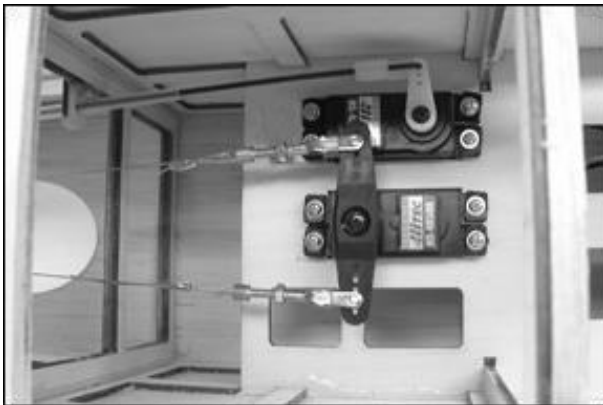

- 25) *NOTE: The mounting of the electric motor in the Rascal 80 assumes that your motor has a typical "X" or "cross" mounting plate on the back of the motor. Also note that the firewall portion of the laser-cut plywood Motor mount is adjustable fore and aft to accommodate Different length motors. In this step we will adjust the motor mount for your particular electric motor. For the Rascal 80 we need a total distance from the back of the plywood motor mount box to the motor's thrust washer to end up exactly 5-3/8". This distance allows the cowling to fit properly.*

- a) Assemble your motor according to the manufacturer's instructions. Then carefully measure the distance from the back of the mounting plate to the front of the thrust washer *.

** The "thrust washer" is the part of the prop adaptor where the back of the propeller will be located.*

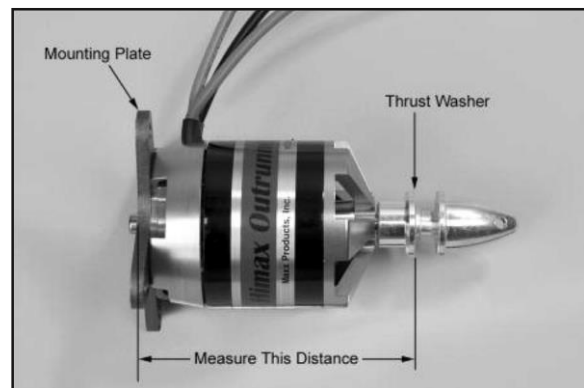

- b) Subtract the measurement taken in the previous step a) from 5-3/8". The result is the distance you need to locate the front of the firewall from the back of the plywood motor mount box. (With the motor we are using in these photos, the motor measurement is 2-3/4". So 5-3/8" minus 2-3/4" = 2-5/8". Your result may be different depending on your motor.)
- c) Carefully measure and mark the distance determined in the previous step from the back edge of the motor mount box towards the front. Do this alongside each of the adjustment slots on both sides of the box (four marks total).
- d) After you have all four slots marked, carefully align the front face of the firewall to line up with the marks. Make sure you end up with the firewall straight and square in the box. If it is not, recheck your marks and adjust as necessary.

- e) Tack glue the firewall in place. Recheck once more to make sure that the front of the firewall is at the correct distance from the back of the motor mount box. That distance plus the length of your motor must equal 5-3/8". When satisfied it is correct, glue the firewall securely to the rest of the motor mount box.

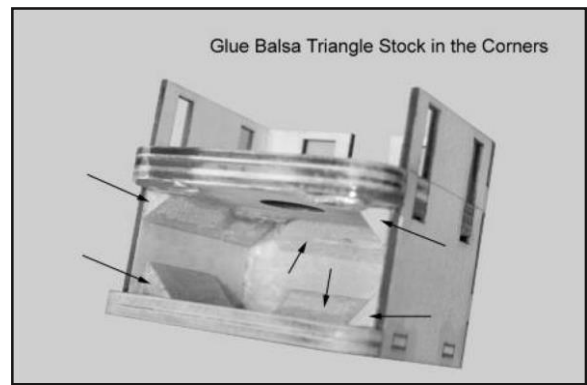
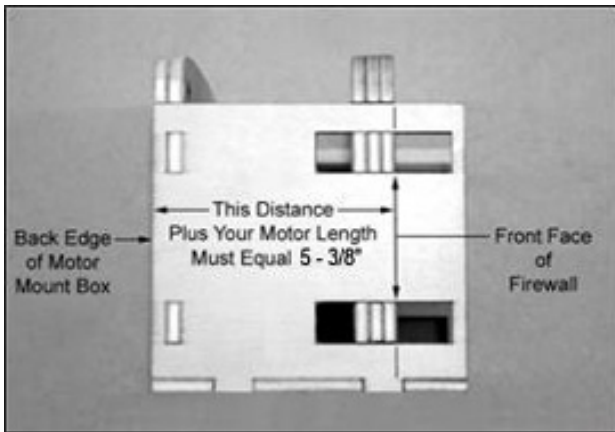

- 26) Remove the X mount plate from the back of your motor and center it on the firewall. Once you are sure it is properly located, mark the mounting holes with a pencil.

Set the X mount aside and drill out the mounting holes with a 7/32" dia. drill. Install four M4 Blind Nuts in the holes, on the back side of the firewall. Put a couple drops of glue on the flanges of the blind nuts to secure them to the plywood, but be careful not to get any of the glue in the threads.

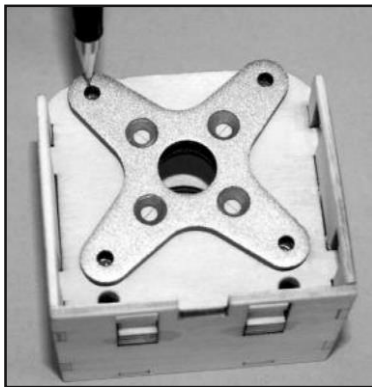

- 27) A long stick of balsa Tri-Stock is provided to reinforce the motor mount. Measure, cut and glue pieces of triangle stock in all the corner joints inside the motor mount box.

- 28) Bolt the plywood motor mount box to the Fuselage with M4 x 20mm Socket-Head Bolts and M4 Flat Metal Washers. Note that two access holes have been provided in the bottom corners of The firewall to allow easy access for your hex wrench.

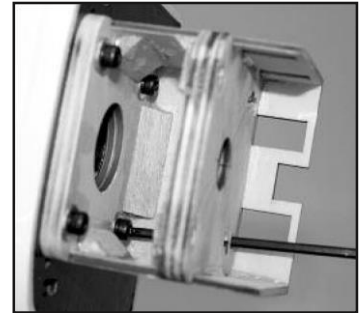

- 29) If you have not already re-attached the X mount plate to the back of your motor, do so now. Then use (4) M4 x 16mm Socket Head Mounting Bolts and Lock Washers to bolt your motor in place on the plywood motor mount box.



- 30) Install your ESC

- a) Solder appropriate battery connectors (not supplied) to the battery leads of your ESC.
- b) Decide on a good location for the ESC in the nose of the airplane. The most likely location is against the fuselage side, out of the way of the battery pack. Mount it to the airplane structure using a method of your choice - like double-sided tape or Velcro® (neither of these are provided). In this case, the Castle Phoenix Edge 75Amp ESC fit perfectly on the bottom of the motor box, and was attached with a pair of servo screws (Not furnished).

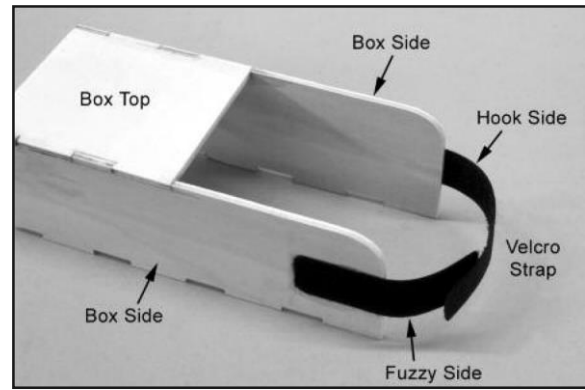

- c) Now route the ESC's servo wire into the fuselage, and temporarily connect it to the receiver.
- d) Connect the ESC's motor wires to the motor. Operate the motor and check the direction of rotation. **NEVER DO THIS WITH A PROPELLER INSTALLED!** If you need to reverse the rotation, refer to the instructions that came with the motor and ESC.

SAFETY ISSUE: We strongly recommend the use of an "arming switch" for your motor installation. With an arming switch you can install your battery pack in the airplane and hook up the wires without danger of the motor starting. The arming switch keeps the electricity away from the motor until you "arm" it when you are ready to takeoff. The most common arming switches are a simple external plug that puts a break in the positive battery lead to the motor, such as the Arming Switch (SIG Part# MXACC6972) shown below. There are also arming switches built into some of the advanced ESCs now on the market.

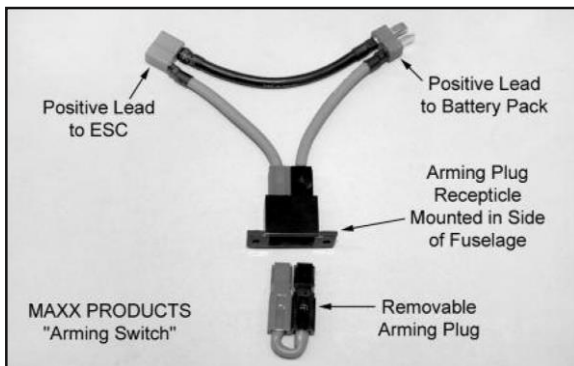

- 31) The LiPo battery pack will ride in a plywood battery box on the floor of the fuselage, just in front of the servo mount. In this step we will install the battery box.
- a) The battery box consists of (2) plywood sides and (1) plywood top piece, and is pre-assembled.
- b) Take one of the supplied Velcro® straps and pull the short, "fuzzy" portion loose from the longer, "hook" strap. Glue one end of the short fuzzy strap on to one of the box sides, as shown in the following photo. Glue the plain side to the wood, not the fuzzy side. Epoxy glue works best for this step.

- c) Cut the hook strap in half, and then glue one end of it to the other box side. The hook side should be glued against the wood. Epoxy glue works best for this step.
- d) Trial fit the assembled battery box inside the fuselage. Note that there are slots in the plywood fuselage floor to accept the tabs on the bottom of the battery box. After you are familiar with the fit of the battery box, glue it permanently to the plywood floor and to the front of the servo mount.

In addition to the Velcro® strap at the front holding your LiPo battery pack inside the box, it is also a good idea to use an additional small piece of Velcro® tape (not furnished) on both the bottom of your battery pack and on the top surface of the plywood floor, to make sure the battery pack will not move around during aerobatics. You can also pad your battery with strips of foam (not furnished) to keep the battery from sliding inside the battery box.

- 32) Mount the cowling on the fuselage with the four M3 x 10mm Screws provided.
- a) First test fit the cowling on the fuselage. As you pass it over the motor, make sure all the wires are out of the way. Carefully adjust the exact position of the cowling. Make sure you have adequate clearance between the front of the cowl and the back of the propeller, and that the prop shaft is centered in the hole. Remove the cowl and tape two 1/2" by 4" strips of tag board to each side of the fuselage.

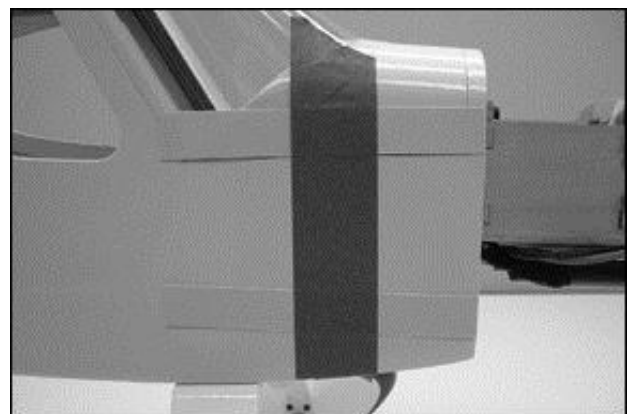

- b) Use a 1/16" bit to drill holes in the firewall for the cowl mounting screws, through the tag board.

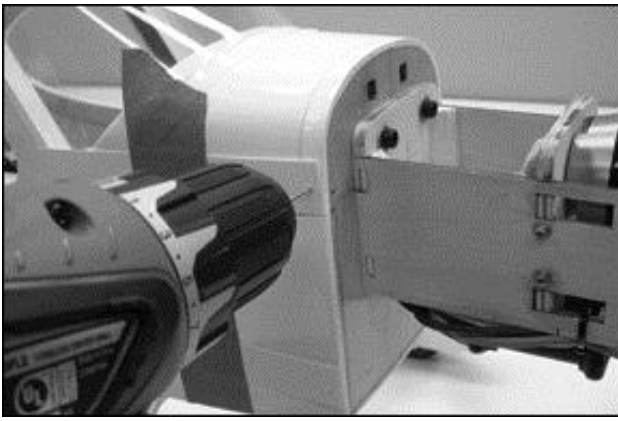

- c) Slide the cowl back into position with the four pieces of tag board on the outside of the cowl. Carefully reposition the cowl and tape it in place with low-tack masking tape. Now drill the four cowl mounting holes through the cowl.

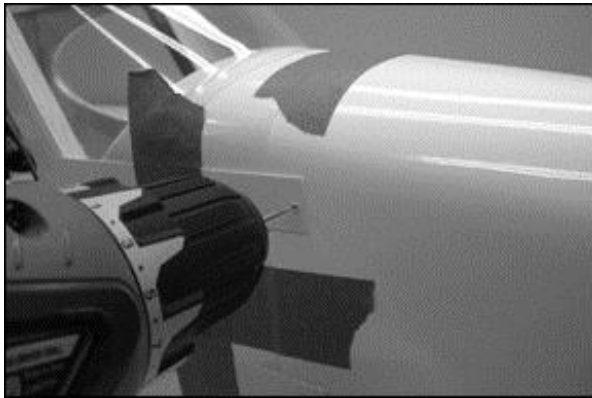

- d) Remove the tape, cowl, and tag board from the fuselage. Screw each of the four cowl screws into a hole and then remove the screws.

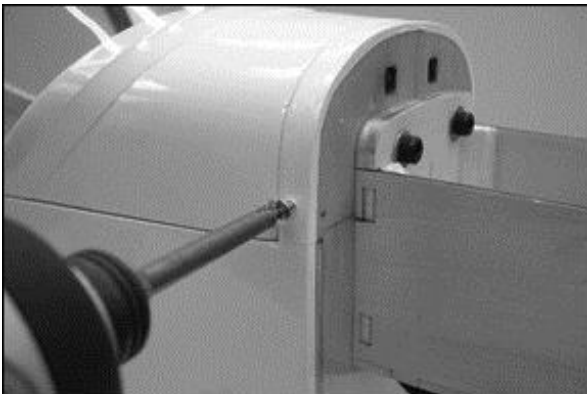

- e) Add a drop of thin CA to each of the four cowl mounting screw holes to harden the holes. Using a 7/64" bit, re-drill the four holes in the cowl. This will allow the cowl mounting screw to easily pass through the cowl without cracking the fiberglass.

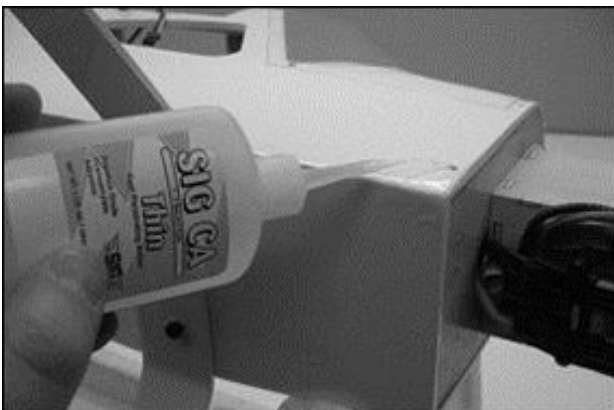

- f) The cowl can now be permanently mounted to the fuselage.

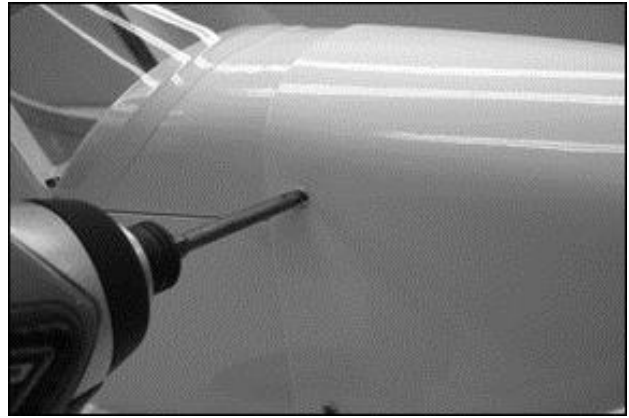

- g) Mount a suitable propeller (not furnished) and the included spinner (optional) on your motor. Be sure to balance the propeller before installation.

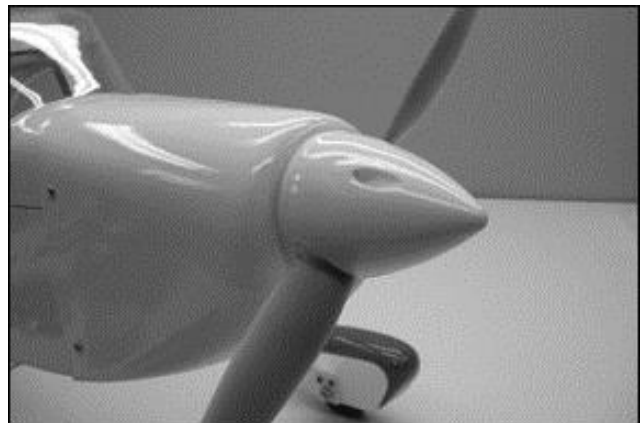
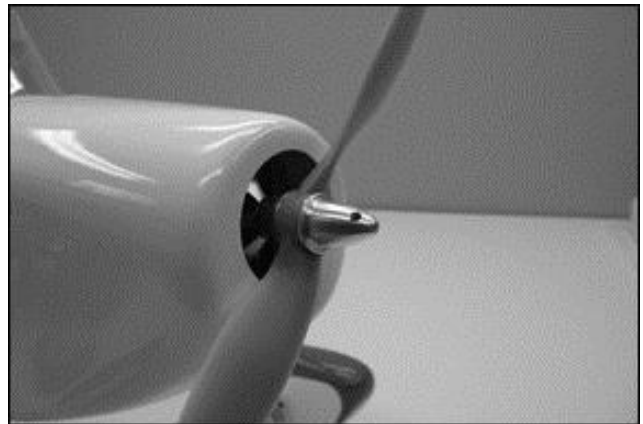

□ 33) COOLING IS IMPORTANT!

With a fully-cowled motor, it is very important to make sure your power system is getting proper cooling. Air flowing into the front of the cowling must have a place to exit the cowl. In fact it's best to have more air exit area than inlet area to create a positive air flow through the cowling - an actual suction effect - drawing the heated air out of the cowling so that more cool air can come in. This positive air flow keeps your motor running cool.

The RASCAL 80 cowling has one large opening in the front to let air in. It also has a generous sized opening at the bottom rear edge of the cowling to let the air exit. However if test flights indicate that your motor, ESC or battery need more cooling, here are a couple additional cooling options.

Option #1) Cut one or more cooling slots in the bottom of the cowl as shown. A Dremel® Tool, or similar rotary hand-tool, with an assortment of bits is without a doubt the best tool to use for making cutout in the fiberglass cowling. However, if you do not have access to such a tool, you can cut the opening with a drill, a hobby knife, and a sanding block. First drill a series of almost touching 1/8" holes inside the pattern lines; then use the knife to cut through the connecting material between each hole; and finally finish the edges of the opening with the file or a sanding block.



Option #2) If you need more air flowing out of the fuselage, make an additional air exit hole by removing the covering material over the hole in the bottom of the fuselage, behind the cabin.

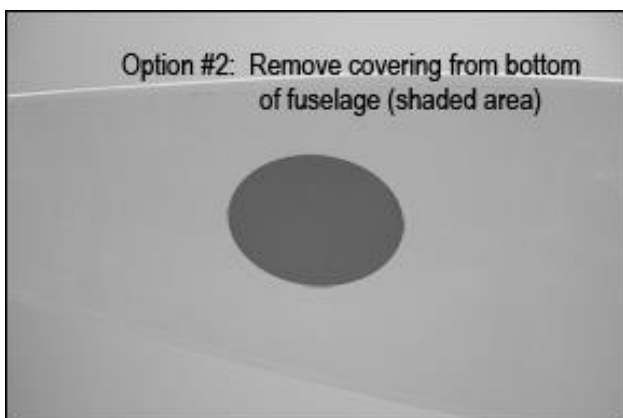

The installation of your electric motor is now completed. Skip the next section on glow power and proceed directly to Page 17, Step 48 about installing a "Receiver Battery Pack".

GLOW POWER SYSTEM

Skip this section if you're using an electric power setup

The RASCAL 80 is a large airplane and is very adequately powered with the 2-stroke or 4-stroke engine sizes suggested. The airplane does not benefit from being over-powered. Doing this tends to put undue stress on the airframe without any real gain in performance. This airplane was always intended to "fly on the wing", not on excessive power.

The engine shown in these instructions is a typical .46 size 2-stroke engine. The engine is mounted in the inverted position. The engine installation for either 2-stroke or 4-stroke power plants is basically the same. The main difference is often times the throttle arm location on the carburetor. The materials provided in this kit should be useful for almost any 2-stroke engine installation. Installation of a 4-stroke

engine may require some alterations and/or specialized fittings (not supplied).

For this section you will need the Fuselage and:

- (1) Fiberglass Cowling
- (4) M3 x 10mm Screws
- (2) Nylon Engine Mounts
- (4) M4 x 20mm Mounting Bolts
- (4) M4 Flat Metal Washers
- (1) Fuel Tank
- (1) Rubber Stopper Assembly
- (1) Fuel Pick-Up Weight (clunk)
- (1) Fuel Line Tubing for inside tank
- (1) Nylon Throttle Pushrod Tube
- (1) 17-3/4" long Wire Throttle Pushrod with Z-bend
- (1) Metal Pushrod Keeper with Set Screw and Hex Nuts
- (2) Zip-ties

You will also need to acquire these items (not supplied):

- (1) R/C Engine and suitable Propeller
- (4) Socket-Head Engine Mounting Bolts, to fit engine
- (4) Lock Nuts for engine mounting bolts
- (4) Flat Metal Washers for engine mounting bolts
- (4) 6 in. lengths of Silicone Fuel Line Tubing
- (1) Silicone Sealer (common kitchen & bath type)

□ 34) Start by putting the Fuel Tank together.

a) Locate the Rubber Stopper Assembly. Note that there are Three black nylon tubes going through the rubber stopper. One of the tubes will be used for the Fuel Pickup Tube, which will then connect to the engine carburetor.

Another tube will be used for the Tank Vent, which is most often then connected to the pressure fitting on the muffler. The third tube can be used for a separate Fill Line if you desire, or it is capped off and the tank filling is done by removing the fuel line at the carburetor and filling through that line.

b) Orient the stopper so that one of the tubes is towards the top and then bend that tube up at a 45-degree angle. This tube will be the tank vent line. Do not apply heat to the tube – it will bend without heat. Just over-bend it to nearly 90-degrees and then let it relax, to see where it will end up. Repeat if necessary until the tube will stay at 45-degrees.

c) Attach the metal Fuel Pick-Up Weight on one end of the silicone Fuel Line Tubing that goes inside the tank. Cut the other end of the fuel line tubing to a length that will allow the clunk to reach the back of the tank, without getting stuck on the walls of the tank. Test fit in the tank and adjust as necessary. With the stopper assembly in place, the fuel clunk should sit just in front of the rear of the tank and move freely inside the tank. If not pull the assembly back out and trim the tubing back until the stopper moves freely. The top of the vent tube should rest just below the top of the tank. It should not touch the top of the tank.

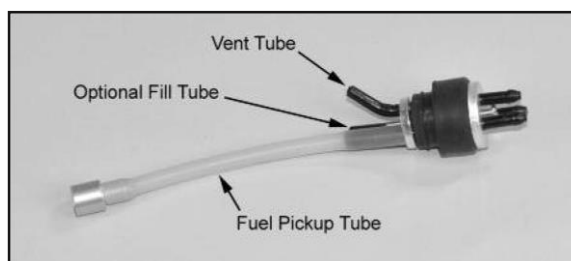

d) Once you are satisfied with the fit of both the fuel clunk line and the vent line you can tighten the screw to expand the rubber

stopper and seal the stopper in the tank. Do not over tighten the screw as it can cause the tank to split. Attach three 6-inch lengths of silicone fuel tubing (not furnished) to the tank and label them appropriately as FILL, CARB, and VENT so you can identify them after the tank is installed in the airplane.

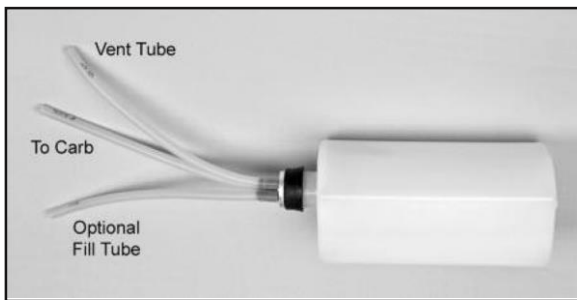

- 37) Set your engine in place on the beams of the engine mounts. Slide the engine forward or aft on the engine mounts until the front of the engine's thrust washer is 5-3/8" from the front of the firewall. Double check to make sure that the engine is pointing exactly straight forward, and then carefully mark the locations of the engine mounting holes on to the beams of the engine mounts.

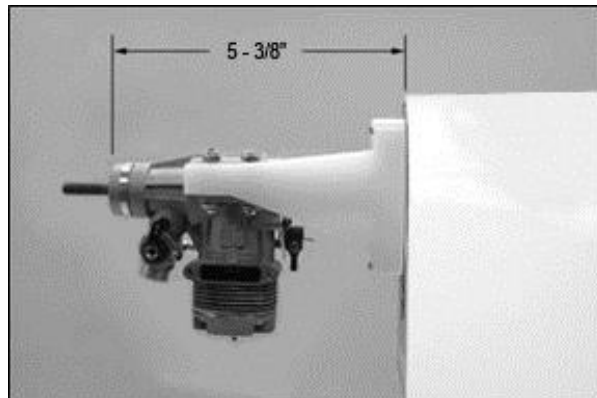

- 35) Install the Fuel Tank in the fuselage.
- First trial fit the tank in place inside the fuselage to familiarize yourself with how it mounts. The front of the tank should fit through the hole in the firewall.
 - Install the two Zip-ties through the forward slots in the tray inside the fuselage.

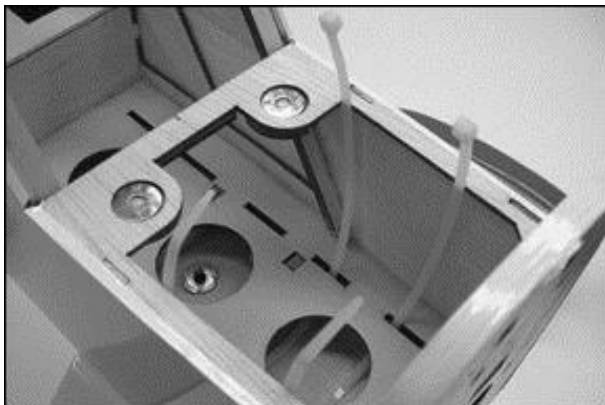

While the engine is in place, mark the throttle pushrod location on the firewall. This can be easily done by lining a pencil up with the throttle arm on the carburetor and marking the firewall.

- 38) Set your engine aside and unbolt the engine mounts from the firewall. Drill clearance holes for your engine mounting bolts all the way thru the engine mount beams at the four locations you marked in the previous step. We recommend that you secure the engine mounts in a vise while you drill the holes. Also, if at all possible, use a drill press to drill these holes. You can drill them by hand, but if you have access to a drill press, the job will be much easier and the holes will be straighter.

SAFETY ISSUE: Do not drill and tap these engine mounts. Doing so may weaken them and cause failure. Use steel mounting bolts, flat washers, and nylon insert lock nuts (not provided), with holes in the mounts big enough to freely pass the bolts.

- Apply a generous bead of "silicone sealer" around the neck of the fuel tank (household bathroom silicone sealer is available at most hardware stores - not furnished).
- Then slide the fuel tank in place, up against the back of the firewall, with the neck of the tank in the hole in the firewall. If excess silicone sealer oozes out onto the front of the firewall, clean it off. Tighten the two Zip-ties around the tank, and glue the balsa retaining block behind the tank.

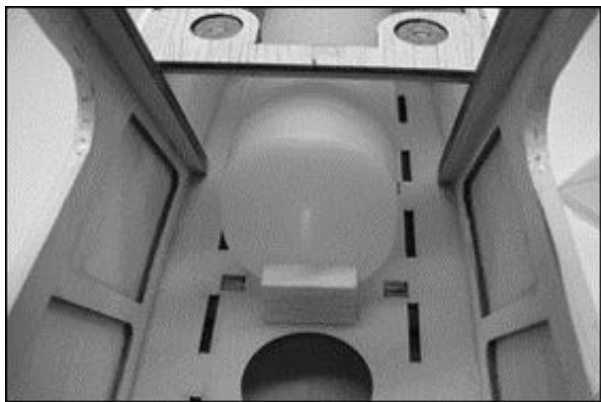

- 39) Drill an 11/64" hole in the firewall at the position you marked for the throttle pushrod.
- 40) Bolt the entire engine and engine mount assembly in position on the firewall. Tighten all bolts firmly. We suggest using a little thread locking compound (not supplied) on all the bolt threads to keep them firmly in place.
- 41) Connect the fuel tank to the engine using heat-proof silicone based fuel line tubing (not supplied).

FILLING THE FUEL TANK

To fill the fuel tank when the 3rd line is capped shut, first remove the other two fuel lines from the carburetor and the muffler pressure fitting. Pump the fuel into the tank through the fuel pick-up line (carb line). When the tank is full, fuel will begin to run out the vent line (muffler line). Stop pumping when you see the fuel start to come out the vent line! Re-connect the fuel lines and you are ready to start the engine.

- 36) Bolt the two Nylon Engine Mounts on the front of the firewall, using M4 x 20mm Bolts and M4 Flat Washers provided. Note that the blind nuts are already installed in the back of the firewall. Leave the mounting bolts slightly loose for now. Do not tighten them until the next step.

- 42) When using a glow engine it is best to seal the battery hatch to keep exhaust and fuel residue out of the fuselage. The reason we built a hatch into this airplane was to provide access to the battery compartment when using an electric motor. Obviously,

you do not need access to that area. We recommend simply tack gluing the hatch in place with a couple small tabs of glue. Then seal over the seams with either clear tape or white covering material (not supplied).

□ 43) 2-STROKE THROTTLE PUSHROD

- a) The first step is to install your throttle servo in the fuselage using the rubber grommets, eyelets, and screws that came with the servo. Mount the throttle servo in the front opening of the servo tray, with the servo control arm to the front.
- b) The supplied throttle pushrod assembly consists of a wire pushrod running inside a nylon pushrod tube. For a typical 2-stroke installation we prefer to connect the Z-bend end of the pushrod to the throttle servo arm. The plain end of the pushrod wire will connect to the carburetor using a Metal Pushrod Keeper, which allows you to easily adjust the overall length of the pushrod at the carburetor.
- c) Install the Metal Pushrod Keeper on the engine's carburetor control arm, with one hex nut on each side of the arm. Note: You will probably need to drill out the hole in the carb arm with a 5/64" dia. (or #47) drill bit to accept the threaded portion of the Pushrod Keeper. Tighten the hex nuts securely against each side of the carburetor arm. Be sure to put a small drop of thread locker on the last hex nut. After the hex nuts are tightened against the arm, the barrel of the Pushrod Keeper should still be free to rotate.
- d) Slide the plain end of the wire pushrod into the back side of the firewall, through the hole you previously drilled in the firewall.



i) Ideally, this is the range of throttle moment you want to achieve:

STICK FORWARD	STICK BACK	STICK BACK
TRIM FORWARD	TRIM FORWARD	TRIM BACK
HIGH SPEED	GOOD IDLE	KILL ENGINE

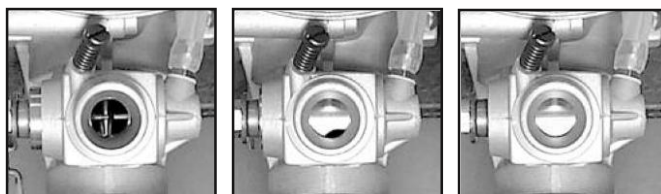

□ 44) 4-STROKE THROTTLE PUSHROD

4-Stroke glow engines typically have their carburetor on the back of the engine. This puts the throttle arm very close to the firewall of the airplane. They also often have the throttle arm on the left side of the airplane, instead of on the right like most 2-strokes. Note that the location for the throttle servo in the plywood tray can be switched with the RASCAL 80. If you plan to use a 4-stroke engine, simply move the throttle servo to the appropriate opening in the servo tray.

□ 45) COWLING

You will most likely need to make a large opening in the bottom of the cowling to clear the engine cylinder head and carburetor. Don't be tempted to quickly dive in with a knife and start removing large chunks of material. You will achieve a lot better result if you take the time to develop a pattern and mark it on the cowling for guidance when you are cutting.

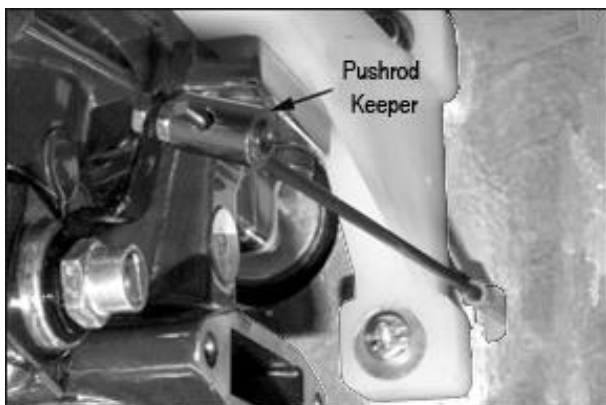

- e) Next slide the Nylon Throttle Pushrod Tube over the plain end of the pushrod wire at the engine. Keep sliding the tube back over the pushrod wire, through the hole in the firewall, and keep sliding it back until approximately 1/2" of the nylon tube remains in front of the firewall.
- f) Now slip the plain end of the pushrod wire inside the pushrod keeper. Attach the Z-bend onto the servo arm and set the servo in the middle of its travel. Set the carb in the middle of its travel, and then tighten the set screw in the end of the pushrod keeper.
- g) Turn on your radio and check the operation of the throttle pushrod. Make adjustments as needed to get full range of carburetor travel. You can adjust the overall length of the pushrod with the Pushrod Keeper. Use the EPA (End Point Adjustment) feature of your transmitter to accurately dial-in the desired amount of servo travel. Also make sure there is no binding in the throttle linkage, which could cause unnecessary battery drain.
- h) When satisfied with the installation, glue the nylon pushrod tube permanently to the firewall with epoxy or silicone sealer. Note: You may find it necessary to support the servo end of the nylon pushrod tube with a scrap of balsa, plywood, or foam - to keep the pushrod from flexing.

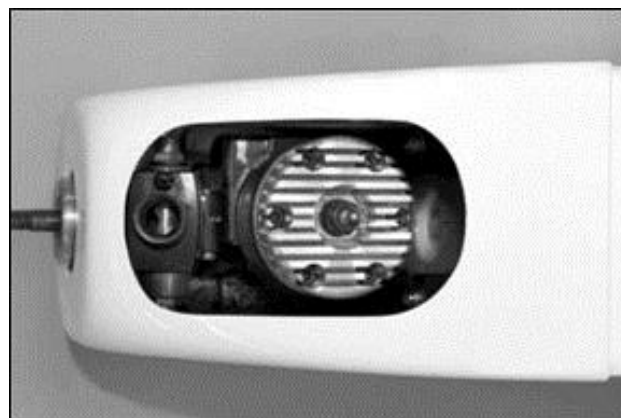

Be aware that there are no hard and fast "rules" for the exact perfect shape for openings in a cowling. Most important, make it big enough to provide the access you need to the engine. The best method is to "sneak up" on these openings, continually trial fitting the cowling over the engine until it finally fits properly. Once the opening is big enough for you to slip it over the engine and place it in correct location on the model, then continue modifying the opening as needed to provide access to the needle valve and the fuel line tubing at the carb.

Note: A Dremel® Tool, or similar powered hand-tool, with an assortment of sanding bits is without a doubt the best tool to use for making holes in the fiberglass cowling. However, if you do not have access to such a power tool, you can cut the opening with a drill, a hobby knife, and a file - by first drilling a series of almost touching holes inside the pattern lines (1/8" dia. works well); then using the knife to cut through the connecting material between each hole; and finally finishing the edges of the opening with the file or a sanding block.

- a) First test fit the cowling on the fuselage. Carefully adjust the exact position of the cowling. Make sure you have adequate clearance between the front of the cowl and the back of the propeller, and that the prop shaft is centered in the hole.
- b) Remove the cowl and tape two 1/2" by 4" strips of tag board to each side of the fuselage.

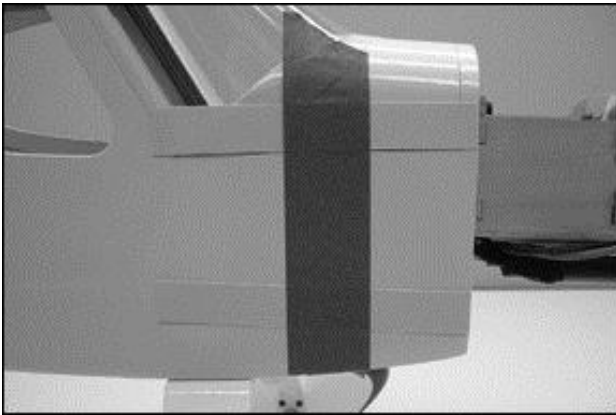

- c) Use a 1/16" bit to drill holes in the firewall for the cowl mounting screws, through the tag board.

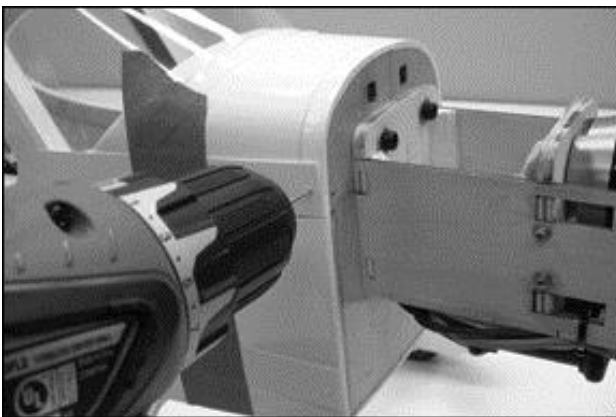

- d) Slide the cowl back into position with the four pieces of tag board on the outside of the cowl. Carefully reposition the cowl and tape it in place with low-tack masking tape. Now drill the four cowl mounting holes through the cowl.

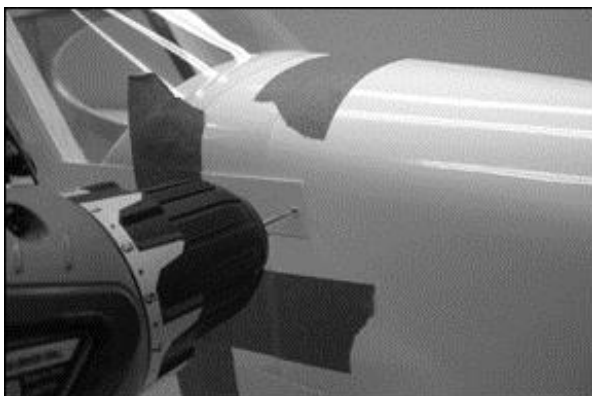

- e) Remove the tape, cowl, and tag board from the fuselage. Screw each of the four cowl screws into a hole and then remove the screws.

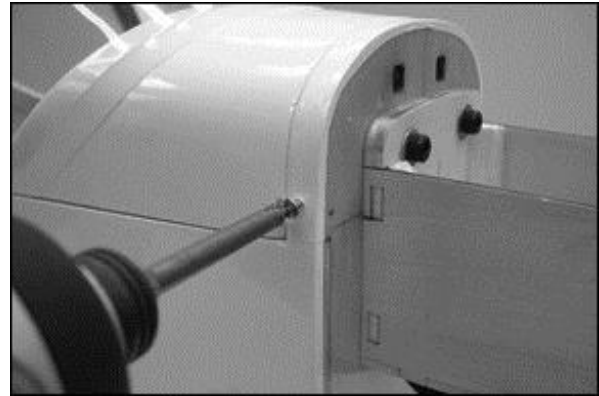

- f) Add a drop of thin CA to each of the four cowl mounting screw holes to harden the holes. Using a 7/64" bit, re-drill the four holes in the cowl. This will allow the cowl mounting screw to easily pass through the cowl without cracking the fiberglass.

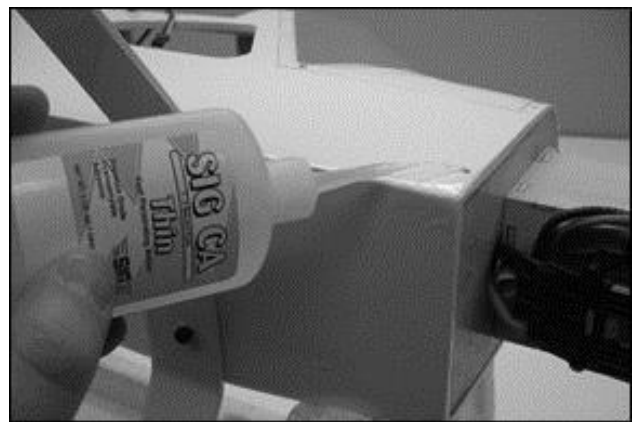

- g) The cowl can now be permanently mounted to the fuselage.

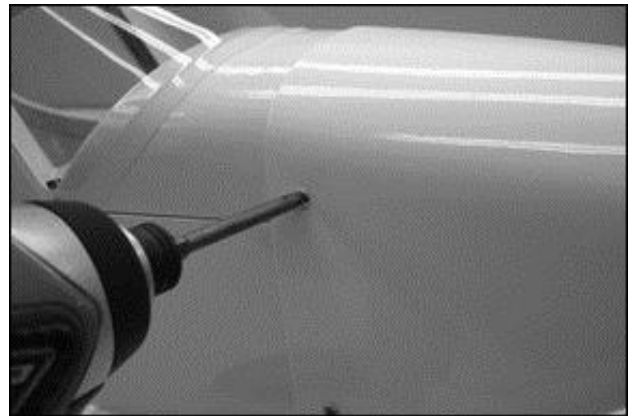

- h) Mount a suitable propeller (not furnished) and the included spinner (optional) on your motor. Be sure to balance the propeller before installation.

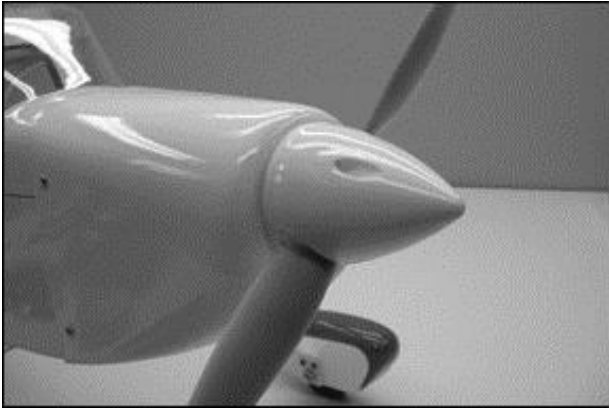

- 46) Make additional holes in the cowling as needed for your muffler and to access the engine's needle valve.

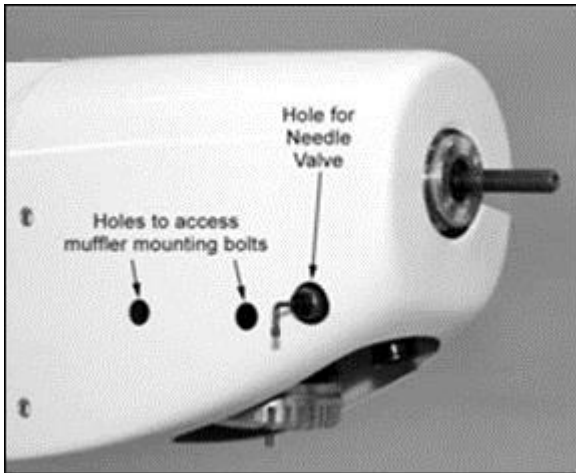
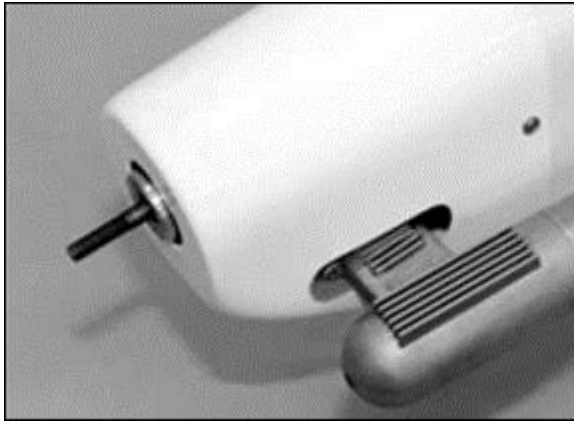

RECEIVER BATTERY PACK

Both glow engine and electric motor users resume assembly here.

- 47) RECEIVER BATTERY PACK
 - a) If you are using a receiver battery pack (all glow and some non-BEC electric motor installations) wrap the battery pack with a single layer of 1/2" thick soft foam rubber to insulate it from vibration and shock. Use tape or rubber bands to hold the foam around the battery.
 - b) For now, leave the receiver battery pack loose on the bottom of the fuselage in front of the servos. Later, when the Center of Gravity (CG) is established, the final position of the battery pack will be determined.

INSTALL SIDE WINDOWS

- 48) From the kit contents, locate the bag containing the molded clear plastic side windows. The clear windows are molded to fit into the fuselage window frames from the inside. Note that each window has a flange all the way around the outside perimeter to provide an easy gluing surface. You may need to trim the flanges a little closer than the factory did, in order to fit them in place. A sharp scissors or snips works best for trimming the windows.

Glue the windows in place with 5-minute epoxy or RC-56 type glue. **Do not** use CA glue because it can cloud the plastic. Apply a thin bead of glue around the edge of the window and press the window in place from the inside of the fuselage. Don't use too much glue or it may ooze out onto the outside surface of the window. Use a few small pieces of low tack tape to hold the window in place until the glue dries.

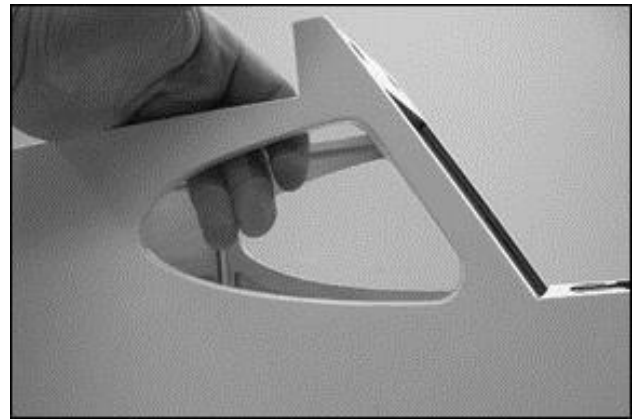

CONGRATULATIONS!

Your RASCAL 80 EG ARF is completely assembled. However, it is NOT ready for flight! There are a few very critical pre-flight tasks we must perform before flying. These are extremely important and should be approached with patience and care.

BALANCE YOUR AIRPLANE

This may be the single most important step in preparing your airplane for flight. All airplanes, model or full-size, must be accurately balanced in order to fly successfully. An airplane that is not properly balanced will be unstable and will most likely crash.

NOT ALL RASCALS WILL BALANCE THE SAME

It is impossible to produce a model airplane kit that will automatically have the correct balance point. Not everyone uses the same engine/motor or radio gear - and all those items can vary in weight! You might be surprised to know that .46 size 2-stroke R/C engines can vary in weight from 11 oz. to 18 oz. - that's almost a half-pound difference, way out on the nose of your model! There can even be as much as a 3/4 oz. difference in weight between different brands of propellers! So, that's why every model must be balanced before flying. Don't feel that whatever the balance point your model came out at is "good enough". Check carefully and make whatever adjustments are required. Trying to fly an out of balance model is dangerous!

Preliminary: All the parts and components that will be in the airplane in flight must be installed in their correct positions. This includes all the radio gear, the propeller, spinner, muffler (if applicable), etc. Every piece of essential equipment must be installed, ready for flight. Always balance a glow powered model with the fuel tank empty. Always balance an electric powered model with the battery pack in place.

RECOMMENDED BALANCE RANGE: 3-1/2" to 3-3/4"
Behind the Leading Edge of the Wing
(Anywhere within this range is acceptable.)

Using a ruler, measure back from the leading edge of the wing and mark the balance range on the bottom of the wing, next to the fuselage. Make the same marks on both sides of the fuselage. Place your fingertips within the balance range on both sides of the airplane and carefully lift it off the table. No part of the model should be touching anything except your fingertips! If the RASCAL 80 will sit on your fingertips in a level attitude, then it is properly balanced and ready to fly.

If the airplane sits on your fingertips in an extreme nose down attitude, then it is nose heavy. You will have to add weight to the rear of the airplane to get it to balance. NOTE: Before adding additional weight to the model, try simply moving the battery pack to a further aft location. The battery pack is relatively heavy and therefore makes a good balancing tool. You might try switching places between the battery and receiver; or move the battery right in front of the servos; or in extreme situations, move it behind the servos. If you can't get your model balanced simply by re-locating the battery pack, then you will have to purchase lead weights from your hobby dealer and glue them into the tail end of the fuselage.

If the airplane sits on your fingertips with the tail down, it is tail heavy. DO NOT ATTEMPT TO FLY IT! A tail heavy model is very dangerous and will most likely crash!! Weight will have to be added to the nose of the model to bring it into balance. The weights can be glued to the front of the firewall. There are also "spinner weights" available for tail heavy models. Wherever you put the balancing weight, make sure it cannot come loose in flight! Because the RASCAL 80 EG ARF has so much wing area, adding balancing weight will have little effect on its flying ability.

CONTROL SURFACE TRAVEL

Double check the alignment and movement of all the controls one more time! Adjust all of your pushrod linkages so that the control surfaces are in their neutral position when the transmitter sticks and trim levers are centered. Make sure the control surfaces move in the proper direction when you move the sticks. You'd be amazed to know how many models have been destroyed on takeoff with one of the controls reversed. Don't let it happen to you! In fact, it's a good idea to get into the habit of checking for proper control response every time you get ready to fly.

Adjust your pushrod linkages and/or transmitter EPA (End Point Adjustment) settings as necessary to provide the recommended amount of control surface travel. NOTE: ALL measurement are taken at the control surfaces widest point.

RECOMMENDED CONTROL SURFACE TRAVEL

AILERONS: 1" UP, 1" DOWN
ELEVATOR: 3/4" UP, 3/4" DOWN
RUDDER: 1" LEFT, 1" RIGHT

FLYING

When it comes to test flying a new model, we always advise modelers to choose a calm day with little or no wind. These conditions allow you to better evaluate and more accurately adjust the trim requirements for your airplane. As we've mentioned before, a good running, reliable motor is a must for the ultimate success of your airplane. Take the time to solve any power system problems before you try to fly.

Always make it part of your pre-flight routine to check each control on the airplane, making sure the surfaces are moving in the correct directions. Also check each control linkage to be sure they are secure and that nothing is loose. With all the controls checked, make a range check with your radio system, making sure everything is working perfectly.

After starting and warming up the engine, taxi the RASCAL 80 out to the take-off position on the flying field, (holding up elevator during the taxi will keep the tailwheel firmly to the ground). For takeoff, the airplane should be lined-up with the center of the field with the nose pointed directly into the wind. Hold a little up elevator and smoothly advance the throttle - do not slam the throttle full open all at once. As the RASCAL begins moving forward, back off of the up elevator input and use the rudder, only as needed, to correct any engine torque and/or wind induced deviations from a straight take-off run. Allow the airplane to lift off, using ailerons to keep the wings level. Climb to a reasonable altitude before making any trim changes.

Although not intended as a trainer, the RASCAL 80 is a very forgiving design that allows you to fly at relatively low speeds, giving plenty of time to learn the basics of R/C flight. With the control movements set at the measurements provided in this manual, the airplane should exhibit smooth, predictable control. Try a few loops and rolls. You will find that the roll rate is not especially high at the initial aileron settings but they can be very axial with practice. Inverted flight is easy, requiring surprisingly little down elevator for level flight. The RASCAL 80 also performs nice inside and outside loops, snap rolls, Immelmann turns, stall turns, Cuban eights, and spins. As with any aircraft, getting consistently good results is a matter of practice. In all of this, we'll bet one of your favorite RASCAL 80 maneuvers will be a long low fly-by - what a great looking airplane!

While still at altitude, throttle the engine back to idle. This will give you a good idea of the glide characteristics. While still at idle, steadily increase up elevator input to get a feel for the stall characteristics. With practice and a little rudder input, the RASCAL 80 can be flown to a virtual standstill before stalling. Stalls tend to be very gentle with one wingtip or the other dropping, followed almost immediately with resumed flight as soon as the elevator is neutralized. This is great information to have when setting up your first landings.

You will find that this airplane has a powerful rudder. As you gain experience and confidence with the RASCAL 80, you will find that you can get some great cross-control action, including almost sideways flight, side-slips, and flat turns. With a little elevator input and a strong motor, the RASCAL 80 will knife edge very well.

Landing the RASCAL 80 is typically a pleasure. We suggest using a standard landing approach, beginning with a throttled back downwind leg and base turn to the final approach into the wind. During final approach, keep just a little power on the engine until the airplane is exactly where you want it for touchdown. In crosswind situations, a little rudder input will likely be needed to keep the airplane lined up with the runway. The RASCAL 80 can be easily landed on either main wheels or in the three-point position. After landing, always remember to hold up elevator when taxiing to keep the tailwheel firmly to the ground.

We sincerely hope that your RASCAL 80 will provide you with many enjoyable flights.

Good luck and safe flying!

CUSTOMER SERVICE

SIG MFG. CO., INC. is committed to your success in both assembling and flying the RASCAL 80 EG ARF. Should you encounter any problem building this kit or discover any missing or damaged parts, please feel free to contact us by mail or telephone.

SIG MFG. CO., INC.
P.O. Box 520
401 South Front Street
Montezuma, IA 50171-0520 USA

PHONE: 1-641-623-5154 FAX: 1-641-623-3922

SIG WEB SITE: www.sigmfg.com

SIG E-MAIL: mail@sigmfg.com

LIMIT OF LIABILITY

The craftsmanship, attention to detail and actions of the builder/flyer of this model airplane kit will ultimately determine the airworthiness,

flight performance, and safety of the finished model. SIG MFG. CO.'s obligation shall be to replace those parts of the kit proven to be defective or missing. The user shall determine the suitability of the product for his or her intended use and shall assume all risk and liability in connection therewith.

JOIN THE AMA

The governing body for radio-control model airplanes in the United States is the **ACADEMY OF MODEL AERONAUTICS**, commonly called the **AMA**. The **AMA SAFETY CODE** provides guidelines for the safe operation of R/C model airplanes. While AMA membership is not necessarily mandatory, it is required by most R/C flying clubs in the U.S. and provides you with important liability insurance in case your R/C model should ever cause serious property damage or personal injury to someone else. For more information, contact:

ACADEMY OF MODEL AERONAUTICS 5161 East
Memorial Drive Muncie, IN 47302
Telephone: (765) 287-1256

AMA WEB SITE: modelaircraft.org

REMOVING THE HATCH FROM THE RASCAL 80

The Top Hatch is held on the fuselage by 2 pins at the front (under the rear edge of the cowling), and 2 magnets at the back of the hatch. To remove the top hatch from the fuselage grasp the hatch near the top of the windshield and lift straight up to disengage the rear magnets. When that happens and the bottom rear corner of the hatch clears the front fuselage former, the hatch will lift back and off easily.

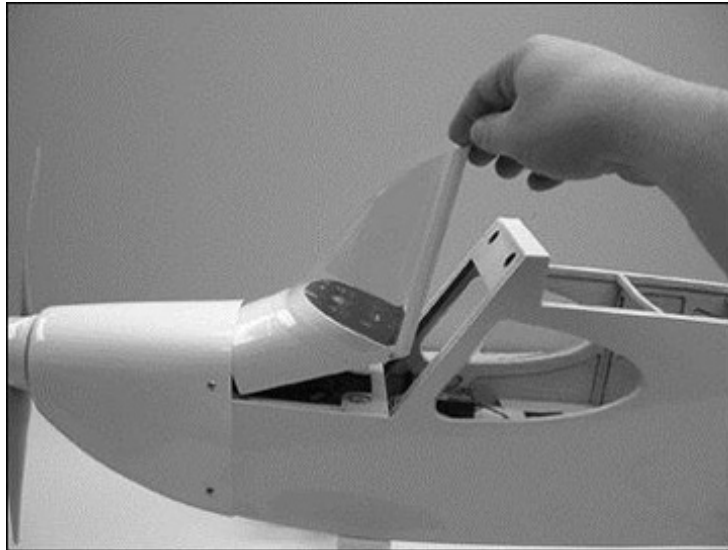

SIG MFG CO., INC.
401 S. Front St.
Montezuma, Iowa 50171 U.S.A.

Copyright 2016 SIG MFG CO., INC.

Printed in Vietnam

****Also Available from SIG****

for GLOW, GAS or ELECTRIC power!

RASCAL 110

Available in two color combinations ...
White & Transparent Red - #SIGRC84ARFR, or
White & Transparent Blue - #SIGRC84ARFB

SPECIFICATIONS
Wingspan: 110 in. Wing Area: 1522 sq.in.
Length: 75-3/4 in. Weight: 11 - 13 lbs.
Wing Loading: 16.6 - 19.7 oz./sq.ft.
Recommended Power
2-Stroke: 1.2 - 1.5 cu.in. (20 - 25 cc)
4-Stroke: 1.2 - 1.8 cu.in. (20 - 30 cc)
Gas: 1.2 - 1.8 cu.in (20 - 30 cc)
Electric: 1600 - 2600 watts; 200 - 270 kv

ARF

**5-CHANNEL
WITH OPERATING FLAPS!**